

AUDIO ENGINEERING

MAY
1948

MAY 25 1948

THE JOURNAL FOR SOUND ENGINEERS



Voice of America!...

... ON **audiodiscs** *

The Voice of America gives to other nations a full and fair picture of American life, aims and policies, plus factual news of the world and the United States.

Broadcast in twenty-three languages, these programs blanket Europe, Latin America and the Far East, with a potential radio audience of more than 150,000,000 persons.

Of the thirty-two hours of daily broadcast, approximately one-fourth of the time is devoted to

news, one-half to additional comment and informational programs, and the remainder to music and entertainment.

A substantial part of these daily programs is recorded and, due to the excellent quality of these transcriptions, such recorded portions cannot be distinguished from the *live* transmissions.

Today, as from the beginning, the recorded parts of these broadcasts are on AUDIODISCS.

AUDIO DEVICES, INC., 444 Madison Avenue, New York 22, N.Y.

Export Department: Rocke International Corp., 13 E. 40th Street, New York 16, N. Y.

Audiodiscs are manufactured in the U.S.A. under exclusive license from PYRAL, S.A.R.L., Paris

*REG. U. S. PAT. OFF.



they speak for themselves **audiodiscs**



Conservation Officer gives detailed fire-fighting instructions to mobile unit summoned by radio.

Motorola Units with Sylvania Lock-in Tubes Guard Michigan Forests Against Fire

Quick action in the early stages of forest fires is a vital factor in their effective control by the Michigan State Department of Conservation. A comprehensive network of two-way radio assures quick action!

Each of the 218 Conservation Officers' cars is equipped with Motorola FM, as are 19 land stations. Supplementing this equipment are 130 AM units in lookout towers, 20 in pick-up trucks, 14 in fixed stations—plus two radio-equipped airplanes. Through this equipment, fire-fighting apparatus is speedily marshaled, effectively directed!

Motorola, naturally, counts on Sylvania Lock-In tubes to help maintain uninterrupted, efficient performance of its mobile units. These tubes stay firmly in place in spite of jolting and jarring. They have few welded joints, no soldered ones. No warping or weaving of elements. Low loss, low leakage. See Sylvania Distributors, or write Radio Tube Division, Emporium, Pa.



Conservation Officer radios his call for needed fire-fighting equipment without loss of a moment's time.



Chief Radio Engineer R. O. Klemetti indicates how fixed land stations are in constant touch with Conservation Officers throughout the state.



Superior mechanical and electrical features of Sylvania Electric's famous Lock-In tube make it the ideal choice for equipment on the road, in the air, on the rails, marine radar, FM and television.

SYLVANIA ELECTRIC

MAKERS OF RADIO TUBES; CATHODE RAY TUBES; ELECTRONIC DEVICES; FLUORESCENT LAMPS, FIXTURES, WIRING DEVICES; ELECTRIC LIGHT BULBS
AUDIO ENGINEERING MAY, 1948

El-Menco PRECISION



POINTS TO

PROGRESS!

El-Menco

laboratory technicians insist on the highest degree of precision at every step in the manufacture of El-Menco Capacitors. They know the important part capacitors play as components in electronic products and how much depends upon their unflinching performance.

This unflinching performance aids immeasurably in the electronic industry's unflinching progress. The use of El-Menco Capacitors throughout the electronic industry is an indisputable testimony in behalf of their superiority.



Write on firm letterhead for catalog and samples.

MANUFACTURERS

Our silver mica department is now producing silvered mica films for all electronic applications. Send us your specifications.

Send for samples and complete specifications. Foreign Radio and Electronic Manufacturers communicate direct with our Export Department at Willimantic, Conn., for information.

THE ELECTRO MOTIVE MFG. CO., Inc.
Willimantic, Connecticut

JOBBERS AND DISTRIBUTORS
ARCO ELECTRONICS
135 Liberty St., New York, N.Y.
is Sole Agent for El-Menco Products in
United States and Canada



MOLDED MICA

El-Menco CAPACITORS

MICA TRIMMER

Member of Audit Bureau of Circulation



Successor to RADIO

John H. Potts, Editor

C. G. McProud, Managing Editor
Lawrence LeKashman, Asst. Editor
Louisa B. Dresser, Edit. Prod. Mgr.

Sanford R. Cowan, Publisher

S. L. Cahn, Adv. Director
H. N. Reizes, Adv. Mgr.
Jerome S. Harris, Circ. Mgr.

Editorial Advisory Board

Howard A. Chinn
John D. Colvin
Paul A. de Mars
C. J. LeBel
J. P. Maxfield
George M. Nixon
S. Young White

Representatives

James C. Galloway
816 W. 5th St., Los Angeles 13, Calif.
Dale International Publications, Ltd.
105 Bolsover St.
London W. 1, England
Harris & Floyd
297 Swanston St., Melbourne
C. 1, Victoria, Australia

Established 1917

CONTENTS

MAY, 1948

Vol. 32, No. 5

Letters 4

Editor's Report 6

A Loudness Control for Reproducing Systems—*David C. Bomberger* 11

An Artificial Reverberation System—*George W. Curran* 13

Factors Affecting Frequency and Distortion in Magnetic Recording—*J. S. Boyers* 18

A Practical Gain Set—*C. G. McProud* 20

Record Review—*Edward Tatnall Canby* 24

Horn-Type Loudspeakers—*S. J. White* 25

Vented Loudspeaker Enclosures—*F. E. Planer, and I. I. Boswell* 29

Audio Design Notes:
Attenuation vs. Frequency, Single Constant K Section Low or High-Pass Filter—*"Stylus"*

New Products 32

Professional Directory 32

Advertising Index 48

COVER ILLUSTRATION

New RCA 44BX broadcast microphones being inspected before shipment at the RCA factory in Camden.

AUDIO ENGINEERING (title registered U. S. Pat. Off.) is published monthly at 28 Renne Ave., Pittsfield, Massachusetts, by Radio Magazines, Inc., J. H. Potts, President; S. R. Cowan, Sec'y-Treas. Executive and Editorial Offices at 342 Madison Avenue, New York 17, N. Y. Subscription rates—United States, U. S. Possessions and Canada, \$3.00 for 1 year, \$5.00 for 2 years; elsewhere \$4.00 per year. Single copies 35c. Printed in U. S. A. All rights reserved, entire contents Copyright 1947 by Radio Magazines, Inc. Entered as Second Class Matter at the Post Office, Pittsfield, Massachusetts, under the Act of March 3, 1879.

The ADC of the ELECTRONICS INDUSTRY



TRANSFORMERS

CATALOG TRANSFORMERS ... that meet our catalog specifications.

SPECIAL TRANSFORMERS ... that meet your specifications.

● A wide range of stock transformers is accompanied by an engineering service that offers industry a dependable source of special transformers for every requirement. Write for catalog or supply specifications for special transformers.

FILTERS

Engineering to provide any filter that you will need. Manufacturing facilities that assure you dependable production schedules and uniformly dependable filters.

Illustrated band pass filter is typical of the unusual engineered filters that **ADC** produces for electronics industry. Write **ADC** for prompt and efficient engineering and production service for filters.

PATCH CORDS and JACK PANELS

ADC patch cords are used as standard by hundreds of broadcast stations over the country. They are preferred for their dependability and quality. Write for catalog.

Jack panels ... companion to patch cords. Molded plastic for better insulation. Used where quality and durability are needed. Mount on 19" relay rack. Furnished with jacks assembled or panels only. Write for **ADC** catalog for complete specifications.

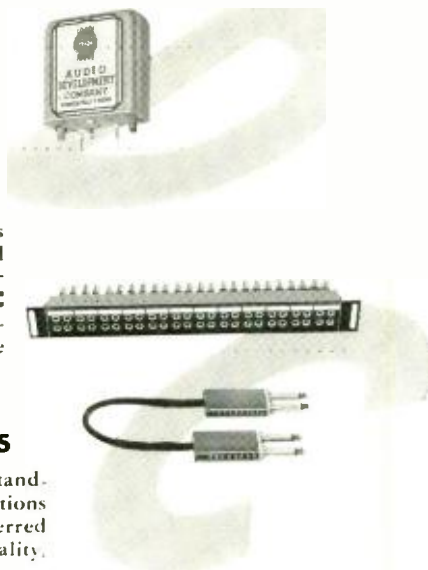

Foreign INQUIRIES SOLICITED

...please direct foreign inquiries to the **ADC** foreign export office same address.

CABLE ADDRESS: AUDEVCO MINNEAPOLIS



Letters

Re: "Toward a New Audio"

Sir:

Every engineer has often nudged his brain for an idea on a device to manufacture, and thereby have himself become independent of his usual job. The plan would be to have more time available for building bigger and better equipment, or some other pet project.

S. J. White's letter in your April issue hit me with a new creative idea right between the ears!

Thinking normally along Aristotelian lines, I believe that the "New Sound" philosophy is based on a strictly irrational principle. But shucks, Sir, what is one to do about philosophic beliefs when there are a few extra shekels to be made?

So I say, more power to the proponents of the "New Sound!" If they can spread the gospel widely enough and convince the public of the "sound's" desirability, my fortune is made. As of this moment, I'm copywriting and applying for patent coverage on a hearing aid type instrument to be worn by every man, woman, and child as commonly as, say, a wristwatch; the idea being that when one has to leave their "New Sound" radio-phonograph behind and attend a concert or the theatre in person, he or she will not be deprived of the subjective delights of the "Sound." You'll note I didn't mention the movies. I sincerely think they've been making great strides in the right direction without the Gospel.

After we have convinced the public that nature has played them a dirty trick with what was up to now "normal" hearing, everyone will beat the proverbial path to my door clamoring for my Universal New Sound hearing device.

Fantastic? On the contrary. Look what custom has done for the mental conditioning of the girls with respect to high spike heels, tight corsets, cosmetics, and the new look. A fellow named Montaigne has written a very erudite essay on how established customs govern our lives, regardless of whether based on rational principles or not.

Just think what my gimmick will do for juke boxes, mothers-in-law, and women with fishwife type of voices. A typical engineer with his normal imagination can see what the application possibilities would be. The thousands of new jobs created to manufacture and service this device, qualify this idea as a further step to man's common good.

What will I do with my leisure time when the money comes in faster than I can spend it? Well, I propose to set up a fancy laboratory and continue my work to duplicate in my living room the subjective reaction experienced at the source.

Bruno Staffen

4435 So. Talman Ave.
Chicago 32, Ill.

Wherever you Employ Magnets,
Check with us on the
Advantages of using

ARNOLD

PERMANENT MAGNETS



As electrical constituents go, permanent magnets are relatively new. They made tremendous advances within the past decade, especially in the communications and aviation industries, and in the general fields of instruments, controls, meters and mechanical holding devices.

Many of these uses were problems that just couldn't be solved until permanent magnet materials were developed to do the job—a work of pioneering to which Arnold contributed a heavy share. Many other applications were those where permanent magnets supplanted older materials because of their inherent ability to save weight, size and production time, as well as greatly improve the performance of the equipment.

To these advantages, Arnold Permanent Magnets add another very important value—standards of quality and uniformity that are unmatched within the industry. Arnold Products are 100% quality-controlled at every step of manufacture. What's more, they're available in all Alnico grades and other types of magnetic materials, in cast or sintered forms, and in any shape, size or degree of finish you need.

Let's get our engineers together on *your* magnet applications or problems.

THE ARNOLD ENGINEERING CO.



Subsidiary of

ALLEGHENY LUDLUM STEEL CORPORATION

147 East Ontario Street, Chicago 11, Illinois

Specialists and Leaders in the Design, Engineering and Manufacture of PERMANENT MAGNETS

W&D 1296

EDITOR'S REPORT

CN\$100,000

● OUR friend F. Sumner Hall recently phoned to tell us that a salesman had just returned from the Orient with a copy of *AUDIO ENGINEERING*, purchased at a bookseller's shop in Shanghai. The price per copy—two months ago—\$100,000 in Chinese national currency.

WIDE RANGE REPRODUCTION

● FROM W. S. Barrell, director of recording at E.M.I. in England, comes a letter taking issue with our popular record reviewer, Bertram Stanleigh, who stated that the new English TT (transient true) recordings, which are stated to include frequencies up to 20,000 cycles, are HMV's answer to the Decca ffr recordings, introduced about two years ago. Mr. Barrell points out that he and an associate were the first to demonstrate wide-range recording, before the Institution of Electrical Engineers, in 1944. In this demonstration, frequencies up to 12,000 cycles were directly recorded and reproduced. Mr. Barrell goes on to say that this was the first time that such wide-range recording had been done, not only in England, but perhaps in the entire world.

Of course, Mr. Stanleigh did not say that Decca was the first to demonstrate wide-range recording; he merely pointed out that Decca had ffr records on the market two years ago, whereas HMV had made no wide-range records available until now. Checking up on work done in this country, we found that F. V. Hunt had reproduced frequencies in excess of 12,000 cycles some 11 years ago, but the recording had been done at lower frequencies. Actually, the records were recorded at 33 $\frac{1}{3}$ rd rpm and reproduced at 78 rpm. Insofar as present recording practice here is concerned, an engineer of one of the largest companies states that they often record up to 12,000 cycles, but they don't make a fuss about it. Maybe so, maybe not, say their competitors. Some engineers claim that an illusion of

better fidelity and wider range is often created by using a very "live" studio, but actually the frequency range isn't unusually wide, and that recordings so made often attain wide popularity and prestige for wide-range qualities they don't possess. From our standpoint, it would seem that if recordings so made really do sound so much better (and we think they do), why don't more recordists use this technique? When it is combined with really wide-range recording, it ought to produce records of really extraordinary quality.

WITH OUR AUTHORS

● NOW that our printer is gradually catching up on his schedule, *AUDIO ENGINEERING* should reach you much earlier in the month from now on. We hope, within two months, to have each issue in the mails on the first of the month. There are plenty of interesting articles now in the works. Our managing editor, C. G. McProud, has just finished an excellent a-m tuner with extremely low detector distortion which will be a worthy companion piece to the 6AS7 amplifier. Another amplifier with exceptionally low intermodulation distortion, and with 35 watts power output, will also be described soon. This article will come from Stromberg-Carlson. Winston Wells is completing his next article on electronic organs, which have been considerably delayed because of his ill health. S. Young White has another outstanding article on ultrasonics, which was squeezed out of this issue.

There is more coming on loudspeaker design, an article on a three-way system, a corner-of-the-room two-way system, and a special speaker layout to give better results from the sound end of TV sets. Practically nothing has appeared in any engineering periodical on record processing. Next month Harold Harris will break the ice with an easily understandable, but authoritative, discussion of the manufacture of phonograph record matrices. Bertram Stanleigh will return with his column reviewing popular records, which missed the deadline for this issue.—J. H. P.

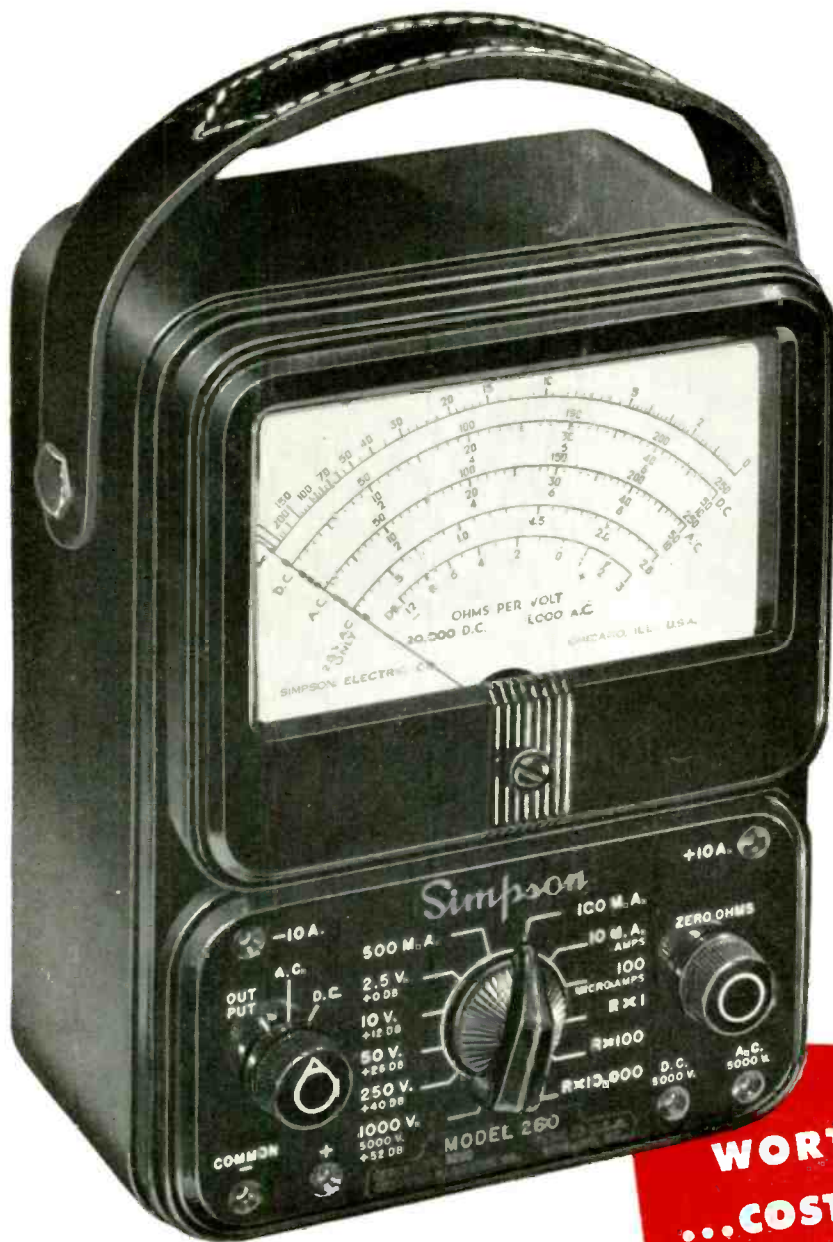

**MODEL 260
VOLT-OHM-MILLIAMMETER**

20,000 Ohms per Volt D.C.
1,000 Ohms per Volt A.C.

Volts, A.C. and D.C.: 2.5, 10, 50,
250, 1000, 5000.

Milliamperes, D.C.: 10, 100, 500.

Microamperes, D.C.: 100.

Amperes, D.C.: 10.

Decibels (5 ranges): -10 to 52 D.B.

Ohms: 0-2000 (12 ohms center).

0-200,000 (1200 ohms center).

0-20 megohms (120,000 ohms
center).

Model 260—Size 5 1/4" x 7" x 3 1/8"
\$38.95

Model 260 in Roll Top Safety Case
—Size 5 3/8" x 9" x 4 3/4". \$43.75

Both complete with test leads and
32-page Operator's Manual*

ASK YOUR JOBBER

**WORTH MORE...
...COSTS NO MORE!**

For what it buys in sensitivity, precision, and useful ranges, the price of Model 260 has always purchased value far beyond that of even remotely similar test instruments. Today this famous volt-ohm-milliammeter is a finer instrument than ever, with added ranges and with a new sub-assembly construction unmatched anywhere in strength and functional design.

The price is the same. That means, of course, that your investment today buys even more in utility and the staying accuracy that distinguish this most popular high-sensitivity set tester in the world.

*No other maker of test instruments provides anything to approach the completeness of the pocket-size 32-page Operator's Manual that accompanies Simpson Model 260. Illustrated with 12 circuit and schematic diagrams. Printed on tough map paper to withstand constant usage.

Simpson
INSTRUMENTS THAT STAY ACCURATE

SIMPSON ELECTRIC COMPANY • 5200-5218 W. Kinzie Street, Chicago 44, Ill.

In Canada, Bach-Simpson Ltd., London, Ont.

FEATURES AND SPECIFICATIONS

1 EQUIPMENT. Designed to give any power output in multiples of 20 watts, i.e. two driver units will give 40 watts, three driver units will give 60 watts, etc. Push-pull output tubes for adequate economical power output to drive one or two speakers. Additional driver stages available to drive any number of speakers. Note: We do not, however, carry a stock of panels or racks for purposes of installation.

2 GAIN. Adjusted for crystal pickup, adequate to allow the use of variable reactance pickup and low sensitivity microphone.

3 HUM. Less than .5 microwatts at 1 watt level—so low as to be inaudible in a quiet room with the ear 12 inches from the speaker.

4 POWER OUTPUT. Uniform within plus or minus 1.25 db from 40 to 20,000 cps at the 20-watt rating.

5 ACOUSTICAL RESPONSE. With a properly selected loud-speaker system, the equipment will produce a 20 to 20,000 cycle response.

6 NEGATIVE FEEDBACK of 8 db is incorporated. This reduces any tendency for distortion and hum.

7 PHONO INPUT. When the phono input is used, the pre-amplifier is adjusted for use with a crystal pickup. However, the separate stage of amplification provided in the MICROPHONE circuit allows a low output pickup (variable reluctance type) to be connected here without requiring additional amplification. A simple equalization network comprising resistance and capacitance is required, of values depending on the characteristics of the pickup selected.

8 TWO OUTPUT IMPEDANCES of 8-16 ohms are available to match several speaker arrangements.

9 BUILT-IN DYNAMIC NOISE SUPPRESSOR uses 4 tubes incorporating three gate circuits, all dynamically controlled. Two circuits control the high frequency, wide band response, and one controls the low frequency narrow band response. The high frequency and low frequency responses are individually controlled from two separate circuits incorporating individual voltage and timing constants. Five positions of control are provided: two for noisy records, one for the off or disconnect position, and two for records that need noise suppression only at times. When the volume level of the record is such that the scratch might be apparent, the dynamic action will automatically allow the reproduction of all the tones to be heard in the acoustical system. The bass gate works the same way protecting against any rumble or low frequency noises.

10 FIVE CONTROLS for simplicity.

- Full range volume control
- Bass control continuously variable. A total variation of 28 db at 100 cps allowing for individual choice of bass boost or cut.
- Treble control continuously variable. A total variation of 25 db at 5000 cps allowing for individual choice of treble boost or cut.
- Selector control selecting the choice of inputs.
- Music control giving the choice of the degree of suppression of noise or the expansion of the tonal range when the noise components are not objectionable.

11 TUBE COMPLEMENT

- 1 6S17 Microphone or high gain pre-amplifier
- 1 6B8 Noise amplifier and diode gate control voltage rectifier
- 1 6SG7 High frequency sharp cut-off gate control tube
- 1 6SG7 High frequency control tube
- 1 6S17 Bass frequency control tube
- 1 6S17 First audio amplifier tube
- 1 6S17 Tone control tube
- 1 6J5 Second audio amplifier tube
- 1 6J5 Third audio amplifier tube
- 1 6SN7G1 Phase inverter and driver tube
- 2 6L6G Power output tubes
- 2 5Y3 Voltage rectifiers

12 ADDITIONAL FEATURES

- Auxiliary AC outlet internally controlled by on-off switch.
- Socket for 6.3 volt pilot light.
- Recorder output terminal.
- Microphone sharing type terminal
- Separately fused for protection.
- Tapped AC line transformer. Low line tap for voltages of 103 volts to 117 volts and a high line tap for line voltages of 118 to 132 volts. This will give maximum performance of the amplifier regardless of the line voltage by the adjustment of the line tap.

This equipment is designed to conform to the regulations of the Board of Fire Underwriters.



PRE-AMPLIFIER CHASSIS — 15¼" x 7¼" x 2½" — aluminum, finished in an aluminite finish



POWER AMPLIFIER CHASSIS — 16" x 10½" x 2" — base is steel, chromium plated and polished

Make your own record player or sound system deliver fidelity, volume, beauty "out of this world" with a

SCOTT Amplifier

Here is the amplifier you have always wanted for your own record player, loud-speaker installation, or sound system.

Now you can have a Scott—an amplifier used in one of the finest Scott instruments—designed to deliver fidelity, tonal quality, volume, range, and beauty of performance never before available.

Features of Two Units

The amplifier comprises two units—a pre-amplifier chassis (including the famous Scott Music Control with Dynamic Noise Suppressor*), and a power amplifier chassis. Fourteen tubes, including two rectifiers—two preliminary stages of audio amplification—a driver audio amplifier—a push-pull power output stage—suitable controls for volume regulation and continuous adjustment of bass and treble response are among the features.

This fine instrument, because of its power handling capacity and wide audio range, delivers reproduction of voice and music with fidelity and range which satisfy the most critical listener. The power output allows reproduction of musical

selections regardless of dynamic range because even on the peaks of volume the capacity of the amplifier is seldom used. The instrument will transmit the entire range of frequencies between 20 and 20,000 cycles without distortion.

No Blast or Distortion

This extremely wide range, beyond that of the average human ear, means that the sheer beauty of the music is undisturbed, without blast, distortion, or a tendency to "spill over" even on fortissimo passages.

The famous Scott Music Control, with the Dynamic Noise and Scratch Suppressor*, brings out soft musical passages in all their delicate beauty, free from annoying scratch and rumble. In loud, brilliant passages, the circuits permit full passage of all the tonal range built into the record. This control, used with the Scott infinite bass and treble controls and volume control, gives you command of performance second only to that of the conductor who presented the music when recorded.

Limited quantity available. Order now for immediate delivery.

SPEAKERS—For balanced performance with Scott Amplifiers. Prices on request

RECORD CHANGERS—Special prices for Garrard Record Changers.

* Hermon Hosmer Scott Patents Pending

Send us this coupon with your certified check or money order and we will ship this amplifier express prepaid to any place within the continental United States at a price of \$180.00. Test it for five days and if you are not entirely satisfied, return it to us express collect and we will cheerfully refund your money, providing the instrument reaches us in the same condition in which it was sent.

Scott Radio Laboratories, Inc.
4541 Ravenswood Avenue, Chicago 40

FIVE DAYS' TRIAL MONEY-BACK GUARANTEE

NAME _____

ADDRESS _____

CITY-ZONE _____ STATE _____

MODEL VH-24
List Price, \$74.50

MODEL VH-20
List Price, \$63.00

MODEL VH-15
List Price, \$47.00

MODEL VH-91
List Price, \$32.50

Listen 4 New
Jensen
*Hypex**
PROJECTORS

AFTER months in the laboratory and a long and costly tooling program, this dominant new line of HYPEX Projectors is now ready. In their design, JENSEN engineers started with complete recognition of the shortcomings of all equipment of this kind and then added their own high concepts of performance and convenience requirements. The result is a striking new high in every detail of design and performance, and a new low in price.

Generous use of such materials as stainless steel and other corrosion-resistant materials, plus elaborate treatment of necessary steel parts, insures against weather exposure. Mounting brackets using clutch-type, heavy trunnion mountings (on all except VH-91), solve finally the problem of adjustment and positive locking into position.

Weatherproof terminal boxes provide a long needed feature in equipment of this kind. The completely new driver unit with molded plastic diaphragm is entirely enclosed within the one-piece rigid horn. And, of course, the recognized superiority of the Hypex formula is employed in the reflexed horn design.

The sound industry has long deserved equipment of this kind. Now it is here and at prices right back to prewar levels.

Write or wire for complete information, we haven't space here to give more than an outline of the features and performance ability of these outstandingly new products.

JENSEN MANUFACTURING COMPANY
6633 S. LARAMIE AVE., CHICAGO 38

In Canada: Copper Wire Products, Ltd., 11 King St., W., Toronto

*PATENT 2,338,267 TRADE MARK REGISTERED.

Jensen
FINE QUALITY EQUIPMENT

NOW AVAILABLE FROM STOCK!

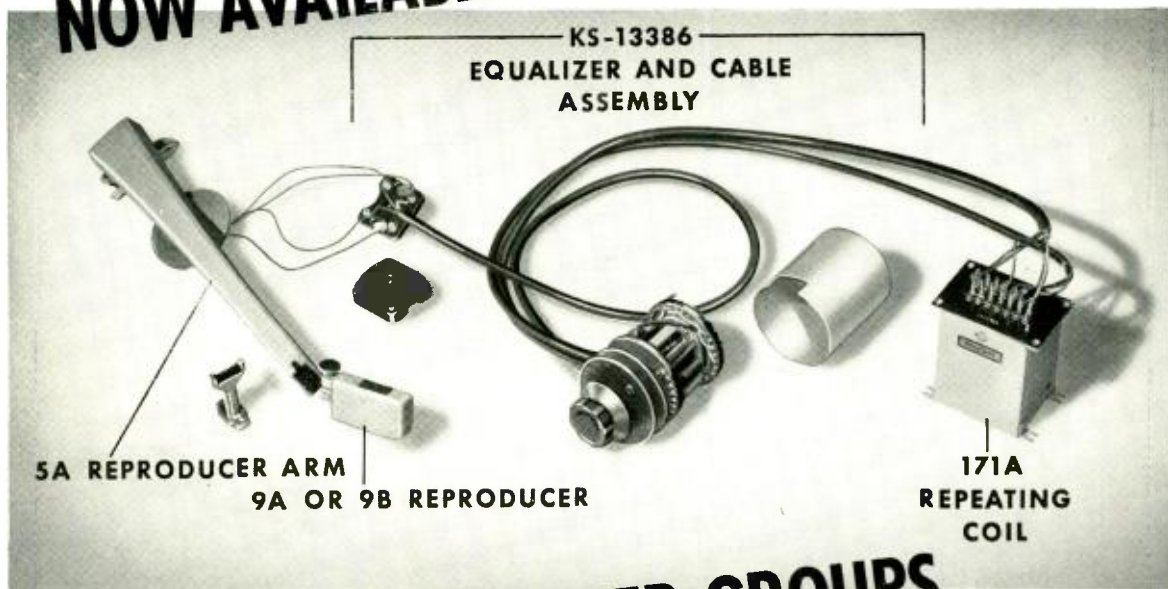

109 TYPE REPRODUCER GROUPS

The time-tested units developed by
Bell Telephone Laboratories — manufactured by Western Electric

They're back in stock again! Western Electric's famous 109 Type Reproducer Groups are now available for immediate delivery.

These practical, efficient reproducer groups for use with any transcription turntable are complete "packages" incorporating reproducer, arm and rest, equalizer and cable assembly and repeating coil.

They're available in two types: the 109AA, with 9A Reproducer, and the 109B, with 9B Reproducer. Both types of reproducers give excellent results on either vertically or laterally cut discs. The 9A, with a 2 mil radius diamond stylus tip, is particularly outstanding on verticals; the 9B, with a 2½ mil sapphire stylus tip, is especially good for laterals.

The improved equalizer switch provides a

choice of 7 positions, 2 for vertical recordings, 5 for lateral. Careful, thorough design and production control assure the closest possible matching of present day recording characteristics. Choice of scratch equalization is provided.

The low intermodulation distortion and wide response of the Western Electric 9A and 9B Reproducers retain for these popular units their leadership in the quality field. *Prove it to your own satisfaction on a well cut disc and wide range system.*

Get the full story on the 109 Groups and the 9 Type Reproducers . . . better still, place your order right now for immediate shipment. Call your nearest Graybar Broadcast Representative, or write Graybar Electric Company, 420 Lexington Avenue, New York 17, N. Y.

Western Electric

— QUALITY COUNTS —



DISTRIBUTORS: IN THE U.S.A.—Graybar Electric Company. IN CANADA AND NEWFOUNDLAND—Northern Electric Company, Ltd.

PROMPT, CONVENIENT REPLACEMENT SERVICE ON 9A and 9B REPRODUCERS

Western Electric factory-rebuilt 9 Type Reproducers are immediately available on a revolving stock basis at your Graybar district warehouse. You can also arrange with your Graybar representative to trade in a used 9A against a new 9B, or vice versa.

Loudness Control for Reproducing Systems

DAVID C. BOMBERGER*

By using the device described, it is possible to maintain a close tonal balance over a wide variation in output level.

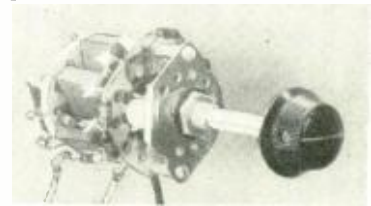

Complete loudness control unit.

A NUMBER of different methods have been utilized to control the output of reproducing systems in such a manner that the tonal balance is maintained reasonably constant at all intensity levels. These controls are essentially variable equalizers which modify the gain-frequency characteristic of the system as the intensity is changed; the desired equalization being specified by the intensity vs. loudness characteristics of the human ear. An ordinary resistive potentiometer is actually a simple intensity control, while a properly equalized intensity control might be termed a loudness control. To maintain constant tonal balance as the intensity is changed, the intensity at low frequencies must be changed less than that at high frequencies. The consequence of changing the intensity equally at all frequencies has been experienced by anyone who has noted the apparent lack of bass in the average radio at low volume settings.

A common type of loudness control employs a tapped potentiometer, with a capacitor and resistor in series between the tapped point and ground. This rather elementary structure is a large step in the right direction, and is attractive because of its simplicity. This very simplicity, however, renders it

*1108 E. Front St., Plainfield, N. J.

capable of yielding only a moderate approximation to the ideal. The loudness control to be described is an elaboration of the tapped potentiometer, and was designed for those applications in which a considerably closer approximation to the ideal is desired, even though some extra cost is involved.

Fletcher-Munson Curves

The basis for design of a loudness control is the set of curves shown in Fig. 1. These are the well-known data of Fletcher and Munson, and are the averaged results of measurements taken with a large number of individuals. Each curve represents a particular loudness, measured in decibels from a reference level; the ordinates of the curve show the intensity in decibels corresponding to that loudness. The departure of these curves from horizontal lines spaced 10 db apart on the intensity scale represents the need for a loudness control. It was concluded that the departure at frequencies above 1000 cps was relatively unimportant, and that only the low-frequency end would be considered. This leads to an appreciable simplification of the problem. Nevertheless, a single network to produce a large loudness change would require a rather complex array of elements because of

the rapid change of intensity with frequency. A large loudness change can more readily be built up by the addition of a number of smaller changes, each having an appropriate intensity vs. frequency characteristic. This procedure is facilitated by the fact that the intensity differences between adjacent loudness curves are quite similar. An excellent approximation to the ideal may be realized by a control which inserts successive units of loss, each similar to the other, and having a loss-frequency characteristic proportional to the average intensity differences between loudness curves. These averages are presented in Fig. 2 as gain-frequency

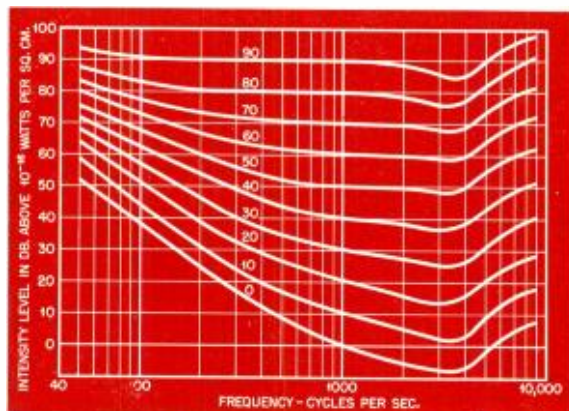

Fig. 1. Fletcher-Munson curves.

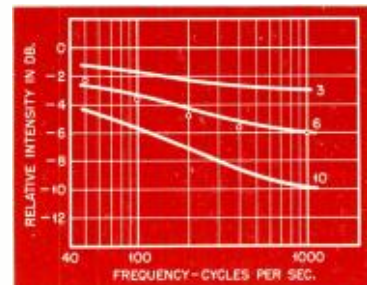

Fig. 2. Curves showing the frequency characteristic of each network section at various intensity levels.

characteristics for 10 db, 6 db, and 3 db loudness intervals. The 3 db interval was chosen for design; it has been found that this increment is sufficiently small for almost all applications where only the listener's reaction need be considered.

It is evident, now, that the loudness control may take the form of a switching device which inserts, successively, a suitable number of identical network sections somewhere in the reproducing system. These sections are designed, on an image impedance basis, to match the characteristic of the 3 db loudness change of Fig. 2, and are inserted between proper terminating impedances. As many of these sections may be placed in tandem as are required to produce the desired loudness change. While this

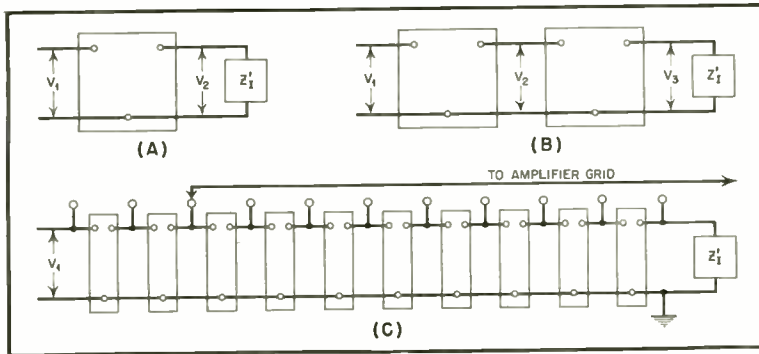

Fig. 3. In (A), representation of network. In (B), two networks in parallel, and (C), ten section in tandem.

control would be satisfactory in its performance, the switching mechanism would be rather unwieldy. A somewhat simpler method of attaining the same end is available.

related to the voltage V_2 on the output terminals by the equation

$$\frac{V_1}{V_2} = \epsilon^\theta$$

Thus the ratio of voltages between input and output of this two-section network is defined by 2θ , and the loss in nepers (or in decibels) at any frequency is just twice that of one section. Consider, now, ten sections in tandem with an appropriate terminating image impedance Z'_I , as in Fig. 3-C. Let the input to the network be the voltage output, V_1 , of a vacuum tube amplifier. Let an eleven-position switch connect the grid of a second vacuum tube amplifier to any of the eleven connection points of the chain. If each network section has a transfer constant such that its transmission is represented by the 3 db curve of Fig. 2, and the terminating impedance is the proper image impedance for that network section, this structure will be a loudness control with 30 db total loudness change, in 3 db steps.

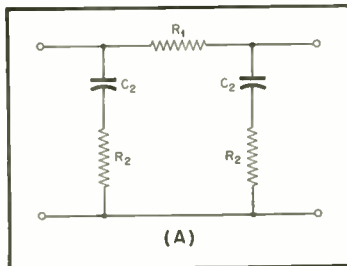

Fig. 4A. Schematic of network section.

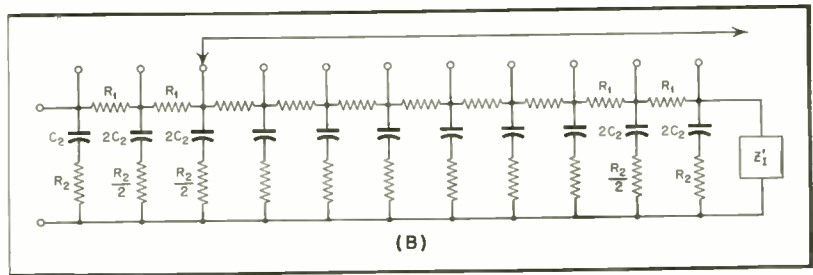

Fig. 4B. Schematic of complete loudness control using the network design of Fig. 4A.

Transfer Constant

The transfer constant of a network designed on an image impedance basis defines the complex ratio between the voltages across the input and output terminals of the network, when the output is terminated in the proper image impedance. Thus, in Fig. 3-A, the voltage V_1 on the input terminals is

In this equation θ is the complex transfer constant whose real part is the loss of the network in nepers. If two identical networks are connected in tandem, as in Fig. 3-B, then three voltages exist, related as follows:

$$\frac{V_1}{V_2} = \epsilon^\theta, \quad \frac{V_2}{V_3} = \epsilon^\theta, \quad \frac{V_1}{V_3} = \epsilon^{2\theta}$$

Network Section

A satisfactory network section is shown in Fig. 4-A. The transmission of this section can be made to match the desired characteristic quite closely. It would, however, require ten series resistors, R_1 , eleven shunt arm resistors, R_2 , and eleven shunt arm capacitors, C_2 , to construct the loudness control of Fig. 4-B. The number of shunt arms with their expensive capacitors may be halved by using, instead of ten 3 db sections, five 6 db sections each divided into two parts. Unfortunately, the voltage in the middle of a section is not related to that at the ends by half the transfer constant; still, the section can be divided in such a manner that exactly half the high frequency loss exists across each portion with only a minor distortion of the low-frequency loss. The exact manner in which the section is divided depends on the image impedance of the section, which in turn requires that the element values be specified. Figure 5-A presents the design of a section which has

[Continued on page 36]

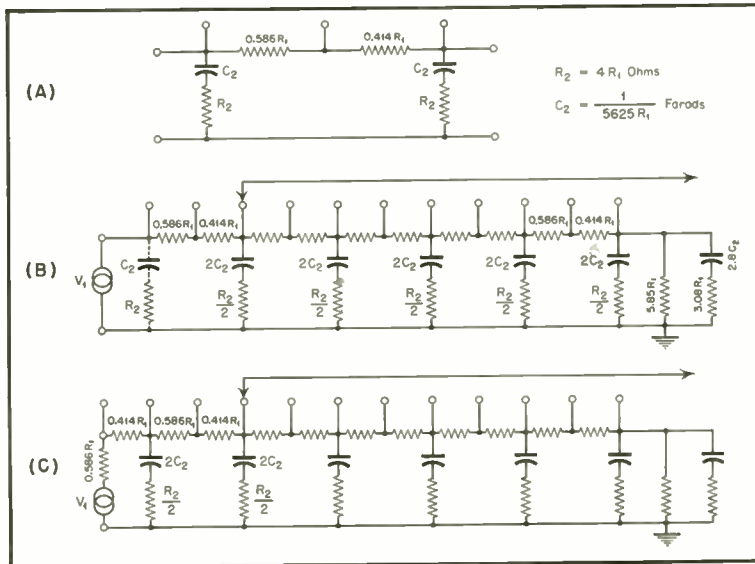

Fig. 5A. Design of section calculated to provide the characteristic shown by circles in Fig. 2.

Fig. 5B. Complete loudness control, including terminating network.

Fig. 5C. Arrangement when the amplifier resistance is $0.586R_1$.

An Artificial Reverberation System

GEORGE W. CURRAN*

ARTIFICIAL reverberation has been a regular adjunct in the broadcasting business for some time, particularly to furnish special sound effects. It has been used less often for the enhancement of live or recorded music, probably because the frequency response of the more familiar systems has usually been inadequate. The following describes a system which has been in use at KFI for over a year, and which has been found suitable for use in either of the two ways mentioned above. Since the requirements for use with musical program material are the more critical, the design was carried out with this function uppermost in mind; at the same time, the system is also sufficiently flexible to produce the usual sound effects.

The pleasing results obtained when music is accompanied by the proper amounts of reverberation have long been recognized by the broadcasting, motion picture and sound recording industries. In fact, published material on the subject is so voluminous that it would be impractical to list all references here. The desired reverberation is obtained preferably from a suitably designed auditorium studio; however, this usually calls for more space than most broadcasters can provide. A next-best substitute of more moderate cost can be obtained by artificial means which, if carefully controlled and wisely used, can give a partial approach to the ideal. It is not necessarily true that the listener's pleasure goes up in proportion to the amount of reverberation present, and this is particularly the case when the reverberation is supplied through artificial means. Just as a good public address system should not intrude itself on the listening audience, artificial reverberation should likewise be so used that the listener is not aware of its presence. It can be overdone easily and extreme care is indicated in its use.

Ideal Requirements

An ultimate artificial system can be imagined which, having a sufficient number of adjustable variables, could be made to reproduce closely the reverberation characteristics of any given auditorium or studio. Such a system should operate so that each original sound is followed by a large number of trains of echoes, each corresponding to a series of reflections from one of the many

Describing a simple, practical system for producing controlled reverberation.

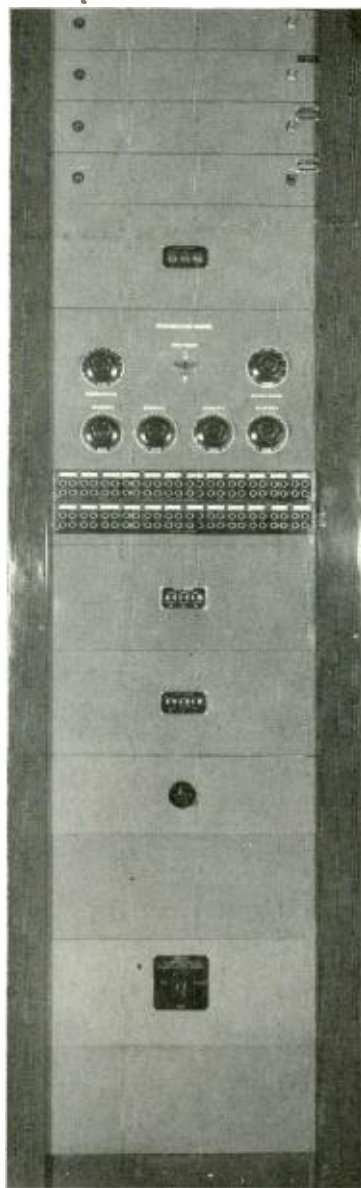

Fig. 12. Reverberation bay of system, comprising amplifiers, control panel, and power supply.

surfaces in the ideal studio. It has been suggested¹ that an illusion of blending is fairly well approached if individual sounds are repeated with spacings of .05 seconds or less. Optimum reverberation times vary from 0.1 to 4 seconds approximately, depending on frequency, volume of the studio and type of program material. The trains of echoes should, therefore, have an adjustable decay time to a maximum of about 4 seconds and, in addition, the rates of decay should be made to change depending on the frequency of the original sound.

Obviously a system with this degree of complication is impractical. Severe compromises are necessary in a practical system. In the present case, only one train of echoes is provided; the spacing between echoes remains constant at about .023 seconds. The train consists of groups of four echoes repeated successively, with no breaks or spaces between groups. The decay rate of the four echoes can be controlled independently and the over-all decay rate of the entire train is also adjustable to a maximum of about 6 or 8 seconds, but both decay rates remain essentially constant with frequency and no control is provided by which this relation can be changed. Lastly, a control is available which determines the ratio of reverberation to original sound. Even with the compromises as described above and with this small number of controllable variables, the illusion is quite surprising, and with many types of music the result is satisfactory even with the ratio of reverberation to original sound advanced to between 1:2 and 1:1.

Operation

A number of media have been utilized for producing delayed echoes; they include coiled springs, magnetic tape,¹ a moving strip of phosphor coating², and large empty rooms.³ The medium used in the system here described** is a long pipe with a loudspeaker at one end and a microphone at the other. Operation can be explained by reference to Fig. 1, a simplified diagram of the essential units in the channel, excluding equalizers. At

** The general features of our channel were suggested by a conversation with Dr. H. F. Olson, of RCA Laboratories at Princeton, N. J., and a similar system has been developed by that organization. Our development, carried out independently, was done almost entirely by Wayne R. Johnson, of the KFI R & D group, to whom much credit accrues for an outstanding job.

*Supervisor, Engineering Research & Development, Earle C. Anthony, Inc., KFI, Los Angeles, Calif.

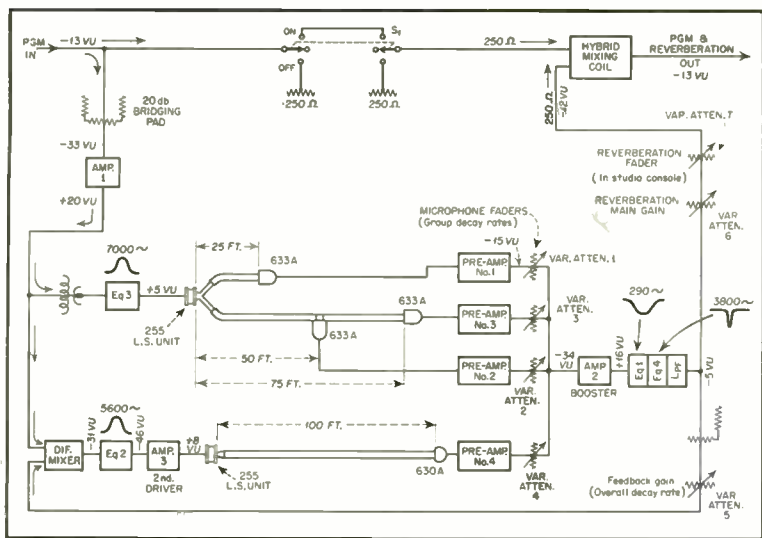

Fig. 1. Simplified diagram showing essential units of the system.

the input (upper left) the incoming signal splits, one portion going along a direct path through a switch S_1 and a mixing coil to the output of the channel. The switch S_1 enables use of the channel in three ways. In the "ON" position, the input terminals look like 250 ohms and a direct path is supplied within the channel itself. With the switch in the "OFF" position, the input terminals also look like 250 ohms but no direct path is provided. With the switch in the center or neutral position, the input terminals look like a high (bridging) impedance and again there is no direct path through the channel itself.

After splitting at the input terminals, the second portion of the incoming signal is fed to the bridging input of the first driver amplifier, AMP 1, which drives the loudspeaker units. The first three units are driven directly from this amplifier while the fourth unit gets its

excitation through a differential mixer network and a second driver amplifier, AMP 3. The loudspeaker units are coupled to four lengths of 1" aluminum pipe 25, 50, 75 and 100 feet long with microphones at the other end to pick up the sound after it has traversed the length of pipe. The sound arriving at the first microphone is accordingly delayed with respect to the original signal by the time required to travel the length of the 25-foot section, approximately 0.023 second. The delay at the second, third and fourth microphones is, respectively, 0.046, 0.069 and 0.092 second, approximately. After passing through pre-amplifiers and microphone faders, these four delayed signals are combined and fed to a booster amplifier, AMP 2, thence through a reverberation main gain and fader, VAR ATTEN 6 and 7, and a mixing coil to the output of the channel. Mixture of the direct and delayed signals

Fig. 2. Effect of channel controls on operation.

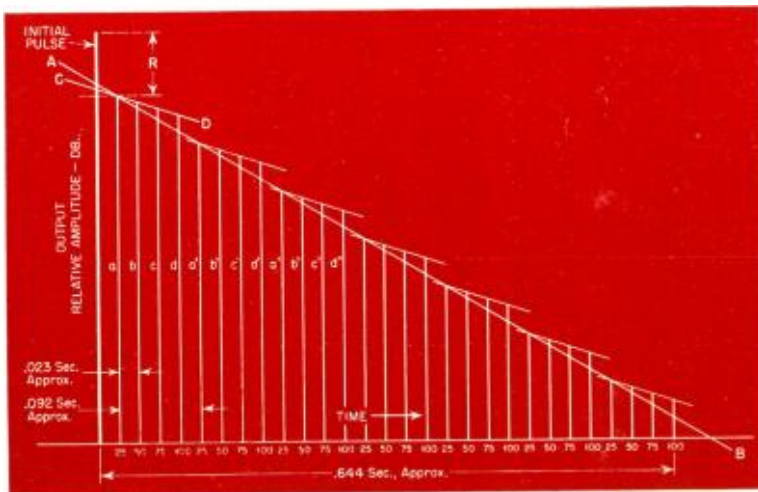

occurs in the hybrid mixing coil. Since they control the amplitude of the delayed signals, the main gain and fader serve to control the ratio of reverberation to original program. The fader is located at the studio mixing position so that the studio operator has continuous control of this ratio.

The delay afforded by the longest pipe, approximately 0.1 second, falls short of the desired 3 or 4 seconds maximum reverberation time. Additional delay could be obtained by using longer sections of pipe, but the 3,000 or 4,000 feet required would be much too large physically and the high-frequency attenuation in such a length would be prohibitive. Instead, additional delay is obtained by establishing a feedback path from the output of the booster amplifier through the gain control VAR ATTEN 5, the differential mixer, the second driving amplifier, and the 100-foot section of pipe back to the booster amplifier. Each time the first four delayed signals traverse this circuit four new echoes appear at the channel output, thus providing successive groups of four echoes with a delay between corresponding echoes of each group equal to the delay through the 100-foot section. The rate at which the groups decay will depend upon the loss in the feedback circuit and hence upon the setting of the feedback gain control. If the frequency response of the entire feedback circuit is flat, this gain control can be opened up until very long delay times are obtained; at the limit the system will, of course, break into sustained oscillation or singing. Under carefully controlled conditions, delays of from 6 to 8 seconds can be maintained; under more practical conditions the delay is usually limited to 3 or 4 seconds, while in actual use delays in excess of one second are rarely needed.

The requirements of flat frequency response through the feedback path are quite stringent. Any small peaks are increased each time a signal makes the round trip through the feedback circuit, and after ten or twenty such round trips the effect of the original small peak has been magnified to large proportions. The irregularities most usually appear in the upper audio range, and it has been our experience that when they are greater than 1 db the over-all result is very tinny in character and the system may break into oscillation before appreciable reverberation effects can be achieved.

Description

Figure 2 illustrates the action of the various channel controls. It shows the series of echoes that might result from certain settings of those controls, when one very short pulse is applied to the channel input. The initial pulse travels via the direct route and appears at the output as indicated at the left of the sketch. Approximately .023 seconds later the first

echo (a) will appear, this being the one produced by the original pulse after traveling through the 25-foot section and thence to the output through the main gain, fader and mixing coil. The ratio between the level of the initial pulse and that of the first echo will depend upon the settings of the main gain and fader, ATTEN 6 and 7, with a given setting of the microphone fader, ATTEN 1. Adjustment of the main gain and fader accordingly serves to change the ratio between the two signals indicated as *R* in Fig. 2.

In the meantime, the initial pulse has also been traversing the 50-foot section of pipe, and it will arrive at the output via the path through the ratio controls as echo (b) approximately 0.023 seconds later than echo (a). The output level of echo (b) with respect to (a), everything else being equal, will depend upon the relative settings of the two microphone faders. Similarly, echos (c) and (d) from the 75 and 100-foot lengths of pipe will arrive at the output each having an additional delay of approximately 0.023 seconds and a level depending on the settings of the associated microphone faders. The settings of these attenuators, therefore, determine the rate of decay of the group of four echoes as indicated by the slope of the line (CD) in Fig. 2.

While the foregoing has been occurring, echo (a) from the 25-foot pipe, having been diverted to the feedback path at the output of the booster amplifier, has been traveling the 100-foot section of pipe to arrive at the output with a total delay, referred to the original pulse, of 125 feet (echo a'). The height of signal (a') with respect to (a) is determined by the setting of the feedback gain control. Similarly, signals (b), (c) and (d) after passing through the feedback path produce signals (b'), (c') and (d') at the output. Thereafter, the process repeats itself to give the succeeding groups of echoes which comprise the whole train. In Fig. 2, the line AB, connecting the tops of the (a) echoes, represents the rate at which the train decays as controlled by the setting of the feedback gain control.

That a one-inch pipe is far from being an ideal transmission line can be seen by reference to the curves of Fig. 3, which show the relative theoretical loss versus frequency of various lengths of this size pipe¹. In view of the large amounts of equalization that were indicated at frequencies above 7,000 cycles per second, this approximate figure was chosen as the top design limit. This decision was strengthened when the available loudspeaker drivers and microphones were brought into the picture. The response characteristics of these units, plus those of the acoustical couplings, added further to the loss at the higher frequencies.

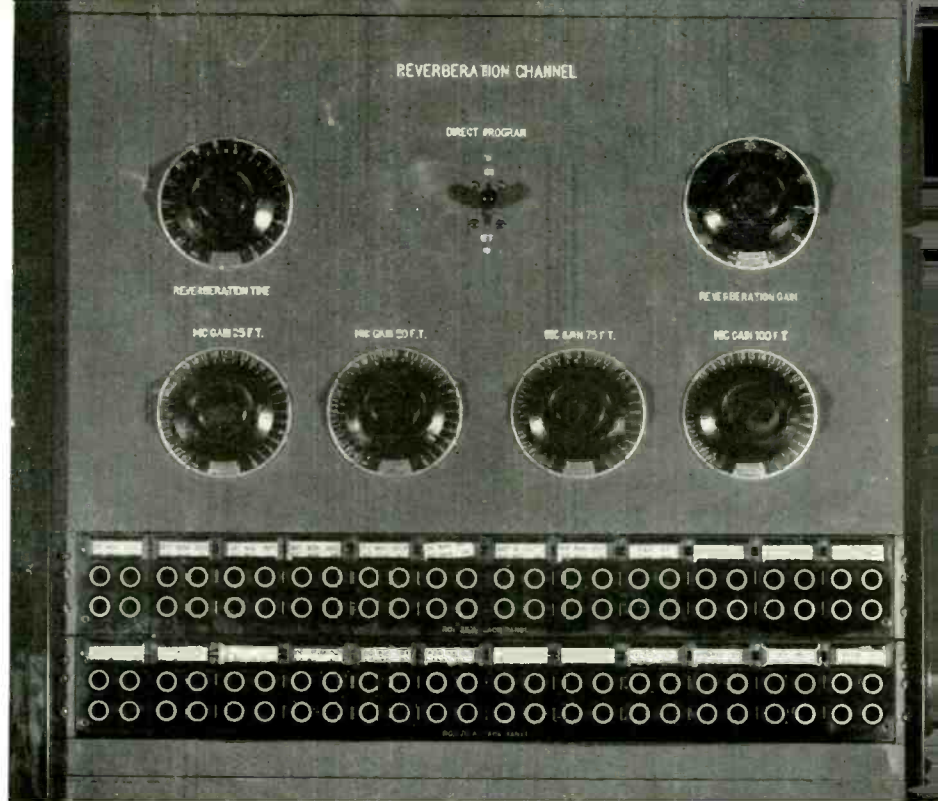

Fig. 13. Control panel of reverberation channel.

Figure 4 shows the total amount of correction necessary over the useful frequency range. This shows the overall relative response of a WE 255 driver and 100-foot section of pipe and a WE 633A ("salt shaker") microphone without any attempt at equalization and without any especial provision for impedance matching at either the sending or receiving end. The ends of the pipe were merely butted up against the driver and microphone and taped in place. Standing waves of small amplitude (about 2 db) present at frequencies below 150 cycles have been averaged out in drawing the curve. The frequency character-

istics of each amplifier used was sufficiently flat so that its effect could be neglected.

Impedance Matching

From consideration of Fig. 4, it was apparent that there was considerable to be done if flat transmission through the 100-foot pipe and the feedback path was to be achieved. At first, the tendency was to be rather indifferent to acoustical impedance matching at the sending and receiving ends. It seemed that the necessary equalization would be better done by electrical means with which we were more familiar. It was soon learned,

Fig. 3. Theoretical transmission loss through 1-inch pipe.

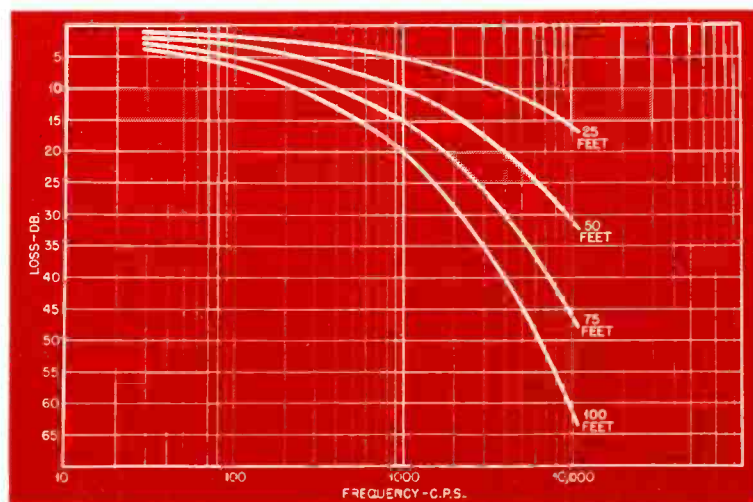

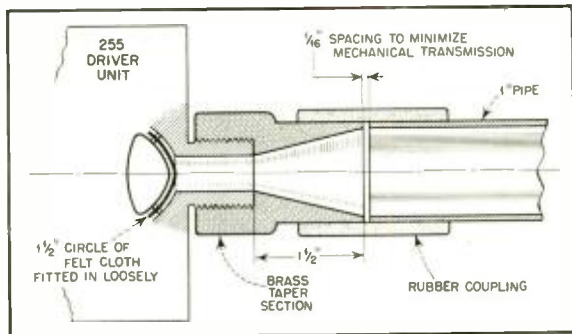
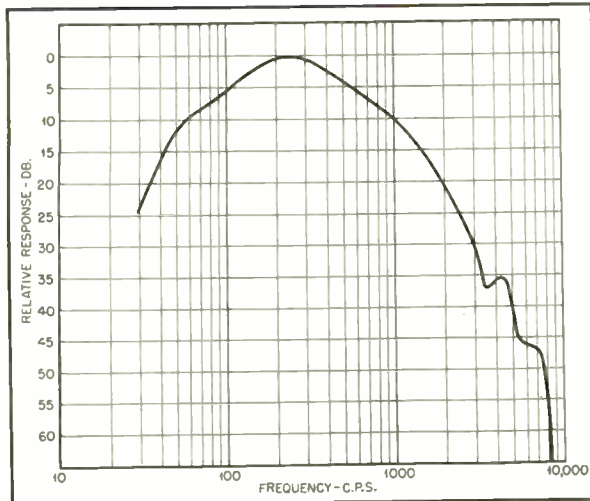

Fig. 5 (above). Method of coupling pipe to driver.

Fig. 4 (left). Response of 255 driver, 100-ft. pipe, 633A microphone, no correction.

however, that efforts spent in obtaining acoustical equalization or in trying to improve the impedance match at driver and microphone, paid worthwhile dividends. Pronounced peaks in the high-frequency region produced by small cavities in the couplings at the transducers, and standing waves which occurred at the lower frequencies, were reduced to negligible proportions when some attention was paid to the fabrication of these couplings. As for acoustical equalization, the few instances in which it was used resulted in an appreciable improvement in signal-to-noise ratio. It was easy to design electrical attenuation equalizers that would accomplish the required corrections, but their relatively high insertion losses caused one or both of two things to happen. Either the desired signal began to approach uncomfortably near to the inherent noise level in the available amplifiers, or the signal level at the receiving end of the longer pipes was so low that pickup of external noise and building rumble by the microphones became objectionable. The acoustical equalization, on the other hand, gave comparatively small insertion losses.

Acoustical Equalization

A brief description of the couplings and the means employed for acoustical

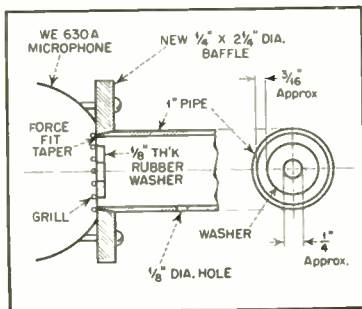

Fig. 6. Pipe coupling and acoustical equalization at 630A microphone.

correction in the final setup may be of interest. They were evolved by a combination of forethought and cut-and-try and are not necessarily the ultimate that can be accomplished. At the WE 255 loudspeaker driver unit which excited the 100-foot section of pipe, a brass taper was provided as sketched in Fig. 5. A thread was turned on the outside of the driver collar to accept the female thread of the taper section; the latter was turned up snug to give a tight fit at the bearing surface on the end of the collar. The

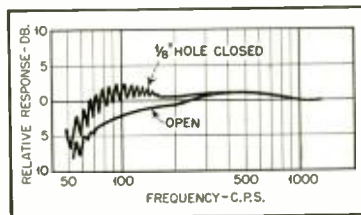

Fig. 7. 255 driver, 100-ft. pipe, 630A microphone, with electrical equalization, showing effect of 1/8-inch opening in pipe wall (see Fig. 6).

flare provided a gradual transition from the small inner diameter at the output of the driver unit to the larger inner diameter of the 1-inch pipe. The pipe was attached to the brass section by means of a snug-fitting length of heavy rubber tubing about 4 inches long. A small gap, approximately 1/16 inch, was left between the end of the pipe and the end of the taper to minimize mechanical transmission of sound between the two components. The only other treatment provided at this point was to insert a small 1 1/2-inch circle of felt cloth, fitted in loosely in front of the phasing plug inside of the driver. Small slits put in the felt to accommodate the small rods that support the phasing plug also helped to hold the felt in place. The felt was inserted to dampen a peak at approximately 4,500 cycles.

At the microphone end of the 100-foot section of pipe, a WE 630A microphone

was used. Its dimensions were appropriate to fit the end of the pipe, as shown in the sketch of Fig. 6. Two mating tapers were put on the outside of the pipe and in the inside of the microphone baffle so as to give a force fit when joined. The pipe and microphone were then taped together for added strength and to give an air-tight joint. The importance of avoiding small air leaks and small cavities in these couplings was demonstrated again and again. Air leaks are equivalent to putting an inductance in shunt with the acoustical transmission line⁴; even small ones cause a pronounced falling off at the lower frequencies. The cavities correspond to a tuned LC circuit across the line, series-tuned if the cavity is closed and parallel-tuned if open, and gives resonant dips or peaks in the higher frequency range. One such air leak was intentionally introduced in the form of a 1/8-inch circular hole in the wall of the pipe near the microphone as shown in Fig. 6. It was used to help smooth out low-frequency standing waves in the long pipe; its effect is shown in the curves of Fig. 7. During final testing of the channel, a portion of the hole was covered with tape by cut-and-try until the desired response was obtained; the final curve used was approximately midway between the two curves. The low-frequency droop incurred was then compensated for elsewhere.

High-Frequency Equalization

A very welcome amount of high frequency equalization, all out of proportion to the simplicity of the means by which it was obtained, was brought about by inserting a small rubber washer against the wire grill of the same 630A microphone as also shown in the sketch of Fig. 6. This microphone was arranged to face upward and the washer was held in place only by its own weight. Presumably it could have been cemented to the wire grill at a few points. The equalization

effected by this simple means is depicted in Fig. 8. Use of this gadget enabled removal of two high-frequency electrical equalizers with a very marked improvement in signal-to-noise ratio.

The remaining equalization required in the feedback circuit was obtained from attenuation equalizers, as indicated in Fig. 1. The computed insertion loss of these equalizers is shown in Fig. 9. One so-called "dip-filter" (Eq. 4) was required to remove a resonant peak in the neighborhood of 3,800 cycles. The other two equalizers had smoother characteristics and were used to build up the less

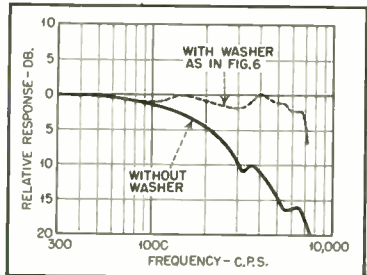

Fig. 8. Same as Fig. 7, showing effect of washer in 630A microphone.

localized deficiencies of the system. In addition, a cut-off filter, having a rather sharp roll-off above 8,000 cycles was inserted mainly to eliminate tube hiss. While all four of these elements (three equalizers and one cut-off filter) were in

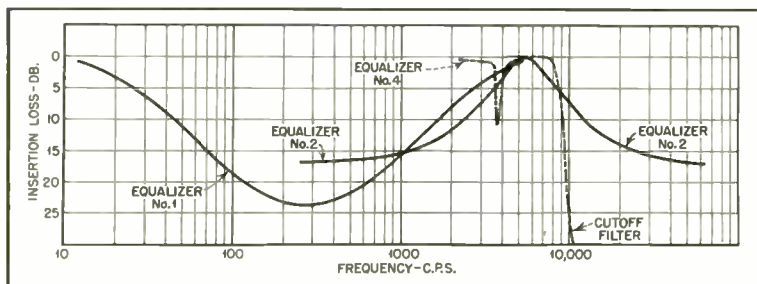

Fig. 9. Insertion loss characteristics of equalizers and filter in feedback path.

the feedback circuit, only one (Eq. 2) was identified solely with the circuit of the 100-foot pipe section. The other three were located so that their characteristics also affected the signals from the three shorter sections of pipe.

Using the acoustical and electrical components described above, the response curve of Fig. 10 was obtained by feeding tone at constant level into the PGM IN terminals and then measuring the relative output at the PGM PLUS REVERB OUT terminals with the switch *SI* in the off position, with all microphone faders turned off except VAR ATTEN 4, and with the feedback gain control turned off. This curve is seen to be within ± 1 db from approximately 80 or 90 cycles to approximately 7,000 cycles. While extending the re-

sponse to somewhat lower frequencies may seem desirable, a roll-off in that region helped to keep down some irreducible building rumble. During listening tests when a program was alternately switched from the direct path through switch *SI* to the path which included the elements measured as described, it was difficult to identify one from the other. Therefore no attempt was made to extend the response further. Total noise, principally building rumble, measured about 45 db below program. When a high-pass filter with cut-off at 40 cps was included in the circuit, the remaining noise level was at approximately 53 db below normal program.

Treatment of Shorter Sections

Since the frequency response through the shorter sections was relatively unimportant compared to that through the 100-foot section, variations of plus or minus 5 db were allowed. Standing waves were also more pronounced as the sections became shorter and amplitudes of 6 db from peak-to-peak were likewise permitted.

For economy, only one WE 255 driver was used to excite the remaining lengths of pipe. A commercially-made "Y" or two-branch loudspeaker connector was attached to the driver and to 25 and 75-foot lengths of pipe. WE 633A ("salt-shaker") microphones were put at the other ends of these sections, and one was

also inserted in the 75-foot section 50 feet distant from the driver. Thus the total length of pipe required and the space it would occupy were also reduced. The "Y" connector had the proper inside diameter at the driver end and no change was necessary there. At the output ends where the inner diameter was too small, there was adequate wall thickness

Fig. 10. Over-all response input to output through 100-ft. pipe and critical units of feedback circuit.

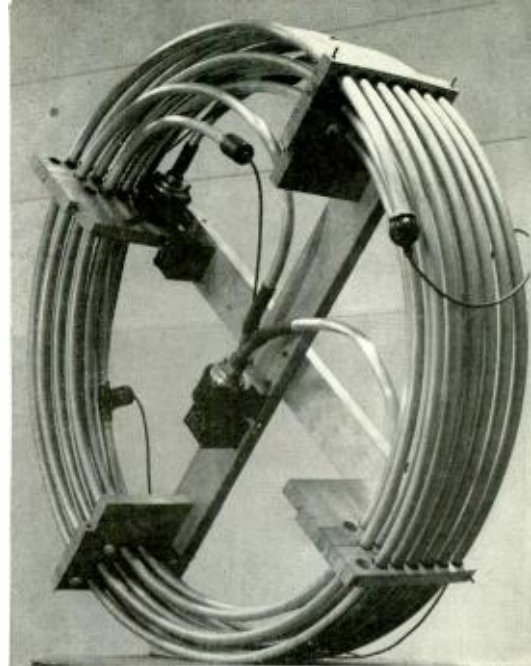
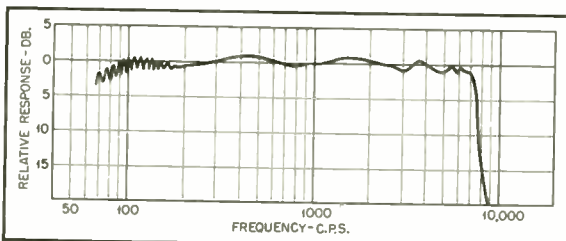

Fig. 14. Pipe unit for reverberation system.

to permit reaming out the ends of the connector to give a flare similar to that shown in Fig. 5. Short lengths of rubber tubing were again used to attach the pipe ends to the branches of the "Y."

In the portion of the "Y" that was connected to the 25-foot section, felt cloth was loosely bunched from the end of the pipe to the apex of the "Y." The attenuation at high frequencies thus introduced served to reduce cavity effect in the connector, and also provided the attenuation necessary to compensate for the lower high-frequency loss in the short section.

The openings in the salt-shaker microphones were of approximately the correct diameter so that they were merely butted against the ends of the pipe and taped in place after small notches had been put in the pipe ends to accommodate the three ribs on the front of the microphone. The taping had to be tight and carefully done for mechanical rigidity and to prevent forming small air cavities.

To attach the third salt-shaker microphone, which was inserted in the side wall of the pipe at the 50-foot point, a brass insert was provided which correctly fitted the pipes at each end. An opening in the side of the insert was then carefully formed to fit the contours of the microphone so that the front surface of the latter imposed a minimum of dis-

[Continued on page 45]

Factors Affecting Frequency Response and Distortion in Magnetic Recording

J. S. BOYERS*

Methods of improving fidelity in magnetic recording are discussed.

AS ONE physics professor often remarks to his classes, before one can make rabbit soup one must first obtain the rabbit. Such is the case in magnetic recording—before one can intelligently design and use a system one must first obtain certain fundamental information concerning its operation. It is the purpose of this discourse to shed a little light on some factors affecting the frequency response and distortion occurring in magnetic recordings.

It is well known that the speed at which a recording medium is moved past the recording and reproducing heads affects, to a very great extent, the frequency response to be expected. This is true regardless of the method of recording, but it is very easy to demonstrate in the case of magnetic recording.

High Frequency Response

All things being equal, the high-frequency response of a magnetic recording system varies nearly directly as the speed of the medium is varied. This can be readily understood when one considers that a certain minimum wavelength can be reproduced by the playback head. A certain wavelength will be recorded for a given frequency and re-

The finite scanning width of the gap used in the recording and reproducing heads has a considerable effect on the high frequency response. Generally, the shorter the scanning gap the greater will be the resolution and consequent high frequency response. Heads for recording on and reproducing from a 0.004 inch wire are usually manufactured with a small piece of 0.001 inch non-magnetic material inserted in the magnetic structure to provide the gap. However, heads for use with tape may be constructed with practically no physical gap, the magnetic gap being caused by a butt joint in the pole piece structure. The resultant discontinuity causes the effective gap.

It is interesting to note that the gap in the *recording* head is not too important because the high-frequency response is a function of the sharpness of the field at the leaving edge of the head.¹ Heads have been constructed which give a very good high frequency response when the wire is run over them in one direction while running the wire in the other direction resulted in very poor high-frequency response. This phenomenon was due to the field at one side of the gap being very sharp while the other

sharpness of the entire gap field. Of course, it is usually the case that the recording head serves also as the reproducing head so it is necessary that this head be very carefully constructed to give a symmetrical and sharp field distribution.

Heads can be constructed which have a very peculiar frequency response. Reference to *Fig. 1* will illustrate this fact. The frequency response curve is for a wire running at four feet per second, and it will be noticed that the first peak occurs at approximately 90 cycles. Consideration of the dimensions of the head will indicate that the first peak should occur at 96 cycles, which is the frequency at which the head structure is one-half wavelength long. These bumps are a result of residual poles which occur at or near the edges of the pole piece used in the head. Various dodges have been used to overcome these irregularities. They usually involve making the head long with respect to the longest wavelength to be reproduced. One head, known as the closed type, when properly constructed, gives very smooth response at low frequencies resulting in a curve having a slope of approximately 6 db per octave, increasing with frequency. This head, however, has a very great disadvantage in that the wire must be threaded through the coil which completely surrounds the wire. Similar effects are noticed in tape heads but to a lesser extent than in wire heads.

Magnetic Characteristics

The magnetic characteristics of the medium and their effect on the frequency response have been well discussed in the literature.² It has been shown that, from a consideration of the principles of magnetism, the high-frequency response is a function of the coercive force while the output at low and middle frequencies is a function of the residual magnetism. This generally is true, but some data have been obtained which tend to show

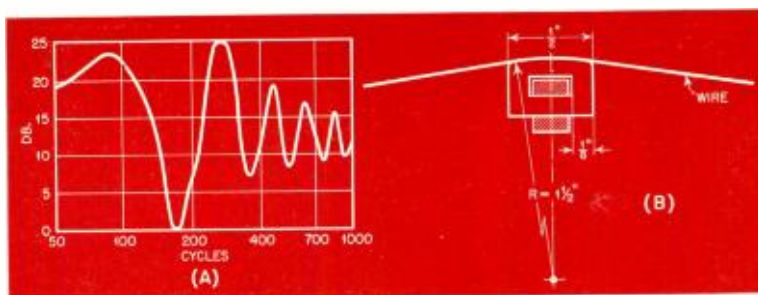

Fig. 1A. Irregularities in frequency response due to residual poles in reproducing head. Fig. 1B. Dimensions of head producing curve shown.

recording medium speed. Thus it follows that by increasing the speed a shorter wavelength will be recorded which the reproducing head will be able to resolve.

*Chief Engineer, Magnecord, Inc., 304 W. 63rd St. Chicago 21, Ill.

side was very broad. In the case of *reproducing* heads such is not the case because the resolution depends upon the

¹Field Measurements on Magnetic Recording heads, Clark & Merrill, Page 1580. *Proc. I. R. E. & Waves & Electrons*, Vol. 35, No. 12, Dec. 1947.

²Theoretical Response from a Magnetic-Wire Record. Marvin Camras, *Proc. I. R. E. & Waves & Electrons*, Vol. 34, No. 8, Aug. 1946.

TABLE I.

He	Ratio of output at 12 kc to output at 1 kc
320	-9.5 db
285	-2 db
285	-6 db
285	-5 db
260	-13 db
260	-9 db

Speed = 4"/sec.
Bias frequency = 65 kc.
Amplitude adjusted for maximum output at 1 kc.

otherwise. Table I illustrates this fact by showing that the wire with coercive force of 320 gauss has a lower high-frequency output than one with a coercive force of 285 gauss, and is about the same order as one with a coercive force of only 260 gauss. It will also be noted that the three wires with a coercive force of 285 gauss have rather wide variations in their 12 kilocycle outputs. These data were taken, and very carefully checked, using a wire drive of four feet per second, a bias frequency of approximately 65 kilocycles, and with the bias amplitude adjusted for the maximum reproduced signal at 1000 cycles. The exact cause of this effect is not known but there seems to be reason to believe that it lies in the composition of the material. Wires of other alloys than the widely used 18-8 stainless steel greatly affect both the output and frequency response with the result that some wires give as much as 10 or 12 db higher output for the same recording level.

The supersonic bias, used to enhance the recording characteristic of a medium, affects the high frequency output of a magnetic record in the following manner. As the bias is increased from a very low value, the output from the reproduce head increases with little change in frequency response. However, after the value of bias which gives maximum output at a medium frequency is reached, any further increase will cause a decrease

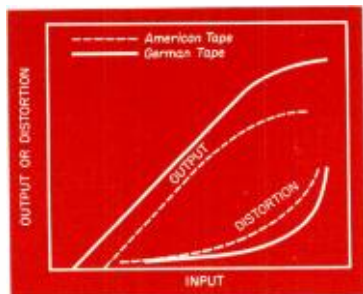

Fig. 2. Relation of input-output curves to degree of distortion.

in the high frequency output. This effect, which may be very serious at high bias currents, is apparently caused by self-erasing of the recording due to the strong bias field.

It is obvious that the amplifiers used with a magnetic recording system must

be capable of reproducing the desired frequency response. It is well known that the output from a magnetic reproducing head in the low frequency region is a differential function. In view of this fact, it is necessary to add integration to the "reproduce" amplifier to compensate for the decreased output at the low frequencies. This imposes very stringent requirements on high quality systems in that the hum originating in the reproduce amplifier must be held to a very low value. Likewise the stray pickup of the reproducing head must be very low. This leads to various shielding and hum bucking schemes, none of which works to perfection! In wide band wire recorders particularly, the reproduce amplifier must have very low noise for best results because the output from the playback head at, say 50 cycles, is in the order of 200 microvolts at the first grid with a signal having low distortion. Tape systems can be designed to give considerably greater outputs than this, making

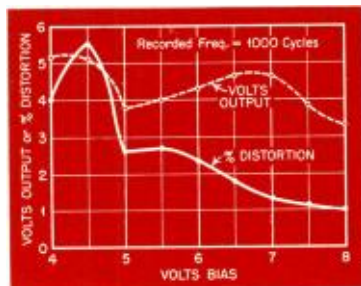

Fig. 3. Distortion as a function of bias applied to the recording head.

amplifier noise requirements less stringent.

The distortion in magnetic recordings is affected principally by the bias and medium used, and to a lesser extent by the amplifiers associated with the equipment.

As will be seen in Fig. 2, the input versus output curve of a magnetic recording medium is a fairly good indication of the distortion characteristics. The dashed curve is characteristic of most available magnetic recording media in which the straight portion of the input-output curve is relatively short, resulting in appreciable distortion at relatively low outputs. The solid curve is characteristic of some newly developed material in which the input-output curve has a relatively longer straight portion resulting in higher output for a given amount of distortion. However, it should not be overlooked that the two approach the same value of distortion at high recording levels. Furthermore, the medium with the longer straight portion will give very serious distortion on overload if it is not operated properly. The fact that some magnetic recordings do not "blow up" on serious overload, as is the case in other recording systems,

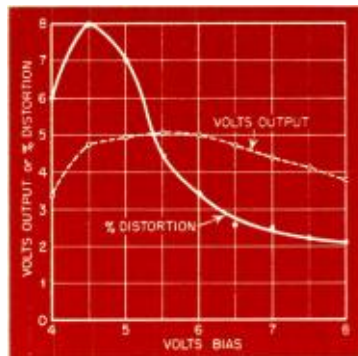

Fig. 4. Distortion vs. bias curves at 100 cycles.

may be attributed to the shape of the distortion characteristic as compared to the recording level.

The decision as to the shape of the distortion curve at maximum recording levels could very easily be difficult in some materials. Naturally it would not be desirable to use a material which had a very steep and abrupt curve because the distortion would increase very rapidly with even slight overload. Conversely, a medium would not be particularly desirable which has a very shallow curve because appreciable distortion may be generated at very low recording levels, thus limiting the signal-to-noise ratio available. It follows, then, that a compromise must be made in which a suitable signal-to-noise ratio is obtained with a satisfactory distortion curve.

When a system using direct current for bias or erasing purposes is designed the engineer must take into account the fact that serious even order distortion will result therefrom. This is not the case in a system using alternating current for bias and erasing purposes. It should be noted that some materials have more susceptibility to even order distortion arising from d-c bias or erase than others. Furthermore, it should not be assumed that just because a system is using a.c. for bias and erase that no even order components are present. Some peculiar effects arise, from time to time, due to accidental magnetization of improperly treated heads through switching transients, head construction, and other causes. Usually it is possible to detect magnetization in heads through the increase in background noise.

Bias Level

In general, the higher the value of the supersonic bias used on a recording head the lower will be the distortion in the reproduced signal. Here a compromise must be made between the maximum level which can be recorded and the desired frequency response because, as mentioned above, higher bias reduces the output at high frequencies. Figure 3

[Continued on page 46]



The author's combination beat-frequency oscillator and gain set. The latter section is practically identical with the unit described.

A Practical Gain Set

C. G. McPROUD*

Design and construction of a simple gain measuring instrument suitable for the small laboratory or the experimenter.

SUCCESSFUL experimentation with audio equipment demands the use of certain types of measuring equipment, although the writer has often pointed out that the ultimate object is "how it sounds." However, once a piece of equipment is completed, it may be desirable to determine its characteristics in order that performance may be maintained over a period of time at the original standard without raising a doubt as to the quality of the amplifying system or any of the components.

One of the most important instruments used in audio work is the gain set. This term is given to a specific form of calibrated loss which introduces a known amount of loss into a circuit. Its principal use is in the measurement of amplifier gain, since it requires gain of some sort in order to function properly. When used for the measurement of filter or equalizer characteristics, the level measuring meter at the output may be an audio voltmeter having facilities for the measurement of levels from 40 to 60 db below the common zero level, which provides the necessary "gain."

This paper describes a simple gain set which can be constructed by the careful technician with the assurance that it will permit the making of various types of measurements with reasonable accuracy. When used with a variable-frequency audio oscillator, frequency response measurements are possible, together with performance measurements on filters and equalizers. When only a single-fre-

*Managing Editor, AUDIO ENGINEERING.

quency source is available, the gain set will measure the actual gain of an amplifier at that frequency. Under these conditions, its usefulness is somewhat limited, and there is relatively little need for it, since the same information can be obtained more easily. When numerous measurements are to be made, however, with a variable-frequency oscillator as the source, the gain set is practically indispensable.

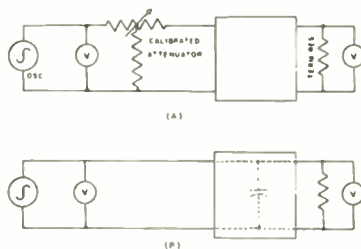

Fig. 1. (A) Basic method of measuring the gain of an amplifier or other component. (B) Resulting circuit when component is a simple capacitor.

Theory of the Gain Set

Primarily, the gain set serves only as a calibrated attenuator. In use, it is connected between the source of tone and the input to an amplifier. The voltage of the source is measured, and the voltage at the output is adjusted by means of the gain set to be exactly equivalent to that at the source. When this is done, it is obvious that the loss in the gain set is equal to the gain in the amplifier, and the gain is thus indicated

immediately. For use with filters or equalizers which have no gain of themselves, it is usual to follow the component to be measured with an amplifier of known characteristics, in order to provide sufficient gain to make up for the maximum loss of the filter or equalizer.

The gain set has one principal difference from the simple calibrated attenuator. To understand this, it is first necessary to review theory momentarily. In the first place, a circuit in which the voltage is held constant is said to be of zero impedance. This is the case at the output of the generator shown in (A) in Fig. 1, when the gain control is adjusted to maintain a constant output voltage. The metered output of the generator is fed through a calibrated attenuator to a component, and thence to the proper termination across which another voltmeter is bridged. If the setting of the attenuator is reduced to zero, the impedance at the output terminals of the measuring equipment is at zero impedance. As the attenuation is increased, the impedance gradually increases until at losses of over 10 db it may be said to approximate the impedance of the attenuator itself. This will introduce no particular trouble provided the component is an amplifier so that the attenuator is set at a loss greater than 10 db, although the measurement will not be truly accurate because the attenuator is not matched to the impedance of the source.

Now, what would happen if the component consisted simply of a capacitor

across the line as shown at (B)? Obviously a capacitor in shunt with an audio circuit will affect the frequency response because of the decrease in impedance of the circuit with increase in frequency. In this instance there will be no attenuation inserted since it is common practice to use the same meter for both source and output voltage measurements. Therefore, since the voltage is held constant across the input it will also be constant at the output, as there is a direct connection between input and output, and the capacitor is simply shunted across the circuit.

This gives a reasonable explanation of the functioning of a calibrated attenuator used for measurement purposes. With such an arrangement, any variation in the input impedance of the equipment being measured is not taken into account, whereas it actually affects the performance to a marked degree.

The circuit arrangement can be modified only slightly by the addition of the resistor R_1 as shown at A in Fig. 2. Assuming that the impedance desired is Z , this resistor will have a value equal to Z , and the impedance of the following attenuator is also Z . Since it is common to use a standard impedance, such as 500 ohms, for this value, and since 500 ohms is also a common output impedance for the generator, the additional resistor R_2 is added across the circuit with a value of $2Z$, making the input impedance of the gain set equal to Z . Now when a measurement is made with the capacitor of Fig. 1(B) in the circuit, its change in impedance with frequency is reflected in the output measurement, since with increase in frequency this value decreases, and since the output is measured across this impedance in parallel with the load resistor R_3 , also equal to Z , the voltage indication is reduced.

Conventional Design

The common form of a gain set is shown in Fig. 3, with one meter being used to measure both the send and receive levels. It will be noted that the meter is tapped down on R_2 , because the voltage required from the source is divided between the resistor R_1 and the load, and is therefore equal to twice the voltage at the input to the attenuator. Therefore, the meter is tapped down at the center of R_2 , making a voltage divider composed of two resistors each equal to Z . With this arrangement, the same meter is used for both input and output levels, and consequently any frequency error in the meter itself is eliminated. If two separate meters were used, it would be necessary to check them to ensure accuracy throughout the entire frequency range over which the gain set were to be used. Since both send and receive levels are the same at the points at which the meter is connected, there is no question of leakage across the switch;

as the level is fairly high, it is not necessary that an especially fine switch be used for this application.

Circuit Elements

In order to design a gain set for practical and inexpensive construction, it is—as always—necessary to make several compromises. In the first place, it is usual for high quality laboratory gain sets to be built with the send and receive circuits balanced to ground. Unfortunately, this necessitates greater expense in the construction of the attenuators, and for the non-professional user, it does not seem to be essential. Most circuits that the experimenter will have occasion to measure are unbalanced; if the gain set were balanced, it would be necessary to insert a transformer between the send terminals and the equipment being measured. For those rare instances in which the input circuit is balanced, it is much simpler to insert the transformer, since such circuits are usually those of high-gain amplifiers, and sufficient resistance isolation can be

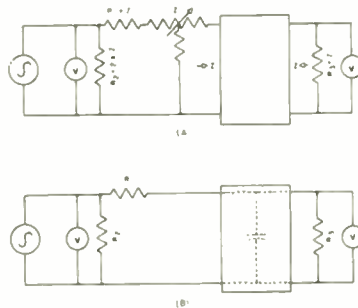

Fig. 2. (A) Series resistor R_1 added to overcome zero-impedance of source when voltage is held constant. (B) Effect of capacitor when gain set resistor R_1 is added.

included in the measuring circuit that the effect of the transformer can be neglected, provided it is of reasonably good quality. Thus it is argued that if a transformer must be used part of the time, it is more desirable that it be used the least number of times, and the unbalanced gain set provides this facility at the least expense.

The next step in the design is to determine how much attenuation is to be provided. Since amplifiers used for public address work often have gains of the order of 120 db, it is desirable that this figure be approached. However, such high losses increase the problems of construction, and it is simpler to increase the range by another method. Normally, any amplifier having 120 db of gain is also capable of putting out a fairly high power level. Therefore, if the low-impedance output terminals are measured, there will be an increase in the range due to the differences in impedances between the 500-ohm meter and the 4, 8, or 16-ohm transformer terminals. For instance, the correction of a 4-ohm circuit is 21 db.

With these considerations, therefore, the total range of the send circuit of a gain set can be limited to 90 db with reason, since an additional 15 to 20 db can be accommodated with the different output impedances of the amplifier to be measured, and a 10-db key in the receive circuit will increase it still further.

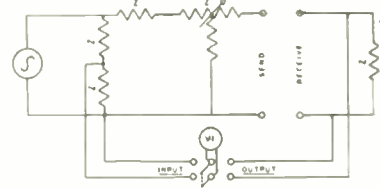

Fig. 3. Simplified schematic of standard type of gain set.

Single pads with losses of over 30 db are considered undesirable, so the attenuator portion will be divided up into two 30-db sections, two 10-db sections, and a switch with ten 1-db steps.

Naturally, it is possible to design a gain set around any desired impedance. The use of high impedances again increases the problems of construction, since the voltages are higher, and the losses throughout the attenuator section are apt to vary with frequency. Common impedances for a gain set are 500 and 600 ohms, with the former value being chosen for this design, since much of the equipment encountered is of that impedance. The addition of two resistors, and the application of a correction factor, will permit its use on 600-ohm lines with equal facility, if the most accurate measurements are desired.

One other facility is also desirable—that of being able to “send” at different impedances. Some commercial instruments provide plug-in networks for this purpose, and others employ transformers. However, a simple resistor network will provide two lower impedances at fixed losses, and with a minimum of switching. Using a nominal impedance of 500 ohms for the main attenuators, a 200-ohm output can be provided at a loss of 10 db, and a 50-ohm output can be provided at a loss of 20 db, both impedance values being common in communication circuits, and the loss values being easy to handle.

Final Circuit

With all these considerations settled, the final circuit for the gain set becomes as shown in Fig. 4. R_1 provides for the adjustment of the signal level from the oscillator, and is arranged so as to give a vernier action to facilitate setting the level accurately. The adjustable attenuators are composed of two separate switches, one providing attenuation of 0, 30, or 60 db, while the other provides attenuation of 0, 10, or 20 db. These switches are followed by a 1 db/step attenuator constructed on the “scaling

hook" arrangement which eliminates the possibility of poor contact on the shunt section of the switch when a three-arm switch is used to vary the loss in a "T" pad. The output pad furnishes three impedances, 500, 200, or 50 ohms at losses of 0, 10, and 20 db respectively. The output is available on two jacks, one being terminated for connection to high-impedance inputs so as to maintain a load for the attenuators, thus ensuring accuracy of the output voltage; the other jack is connected so as to remove the termination when the plug is inserted.

The receive section of the gain set consists of another pair of jacks, one of which connects directly to the meter switch through a series resistor and a shorting switch, while the other provides a termination of 500, 16, or 4 ohms, as selected by another switch. The series resistor is used to increase the output indication of the meter by 10 db, and is used when higher output levels are to be used. This provides a total of 121 db loss in the gain set when sending at 500 ohms and receiving at 4 ohms, or 141 db when sending at 50 ohms and receiving at 4 ohms.

Construction Details

The construction of a gain set should follow standard practice, considering that there is quite a difference in level between the receive jacks and the send jacks when high gain amplifiers are being measured. All connections between the

switches should be with shielded wire, and only one point in the entire circuit should be grounded to the cabinet. It is suggested that the unit be constructed in a small metal cabinet, entirely enclosed, and that the jacks be insulated from the panel. The unit shown at the heading of the article utilizes the same type of gain set as described, in combination with a beat-frequency oscillator, and has been in use for a number of years. This model uses key switches for the fixed pads, but this construction is considered rather more expensive, and the keys used necessitate some maintenance. The switches recommended for this use are the Centralab lever type, 2-pole, 3-position. The 1-db step attenuator can be built up on a Mallory 1231L switch with the stop removed so as to permit rotation through 360°. The rotor of the center section should be removed, and the taps used simply as tie points for the resistors. The meter transfer switch can be a DPDT toggle switch with both sections in parallel.

The one problem which may trouble the constructor will undoubtedly be that of obtaining accurate resistor values for the various pads. This may be solved easily if an accurate bridge is available for the measurement of a number of 1/2-watt resistors to obtain the exact values. Another method is to order them wound special by one of the many companies which do this type of work. However, it should not be too difficult to select

ordinary 1/2-watt resistors with sufficient accuracy for the job. Obviously, the over-all accuracy of the gain set depends upon the accuracy of the individual resistors comprising the pads, and it is suggested that the resistors be selected with an accuracy of at least 2 per cent.

The resistors used in the receive circuit should be of somewhat higher power-carrying capacity, since they may be required to dissipate considerable energy. The 500-ohm load resistor R_7 should be a 2-watt unit, while R_8 and R_9 can be a single 20-ohm, 25-watt adjustable resistor with the sliding tap set so as to provide the 16- and 4-ohm sections. The value of R_6 depends upon the type of meter used, and it is easily selected. Simply connect an amplifier to the send terminals, with the output connected to the receive terminals. Then with the gain set adjusted so as to provide a zero indication on the meter with S_{wg} at OUTPUT, open S_{wg} , and decrease the loss in the send section so as to raise the output level of the amplifier by 10 db. Then bridge a resistor across S_{wg} which will just give a zero indication on the meter again. The value will depend somewhat on the resistance of the meter, but for the usual meter with a resistance of approximately 5,000 ohms, this value will be of the order of 10,800 ohms.

The final selection, which has not been mentioned so far, is the volume indicator meter itself. A standard type of rectifier meter, calibrated in db, is desirable, and

Fig. 4. Complete schematic of low-cost gain set easily constructed by the experimenter to facilitate measurement on apparatus.

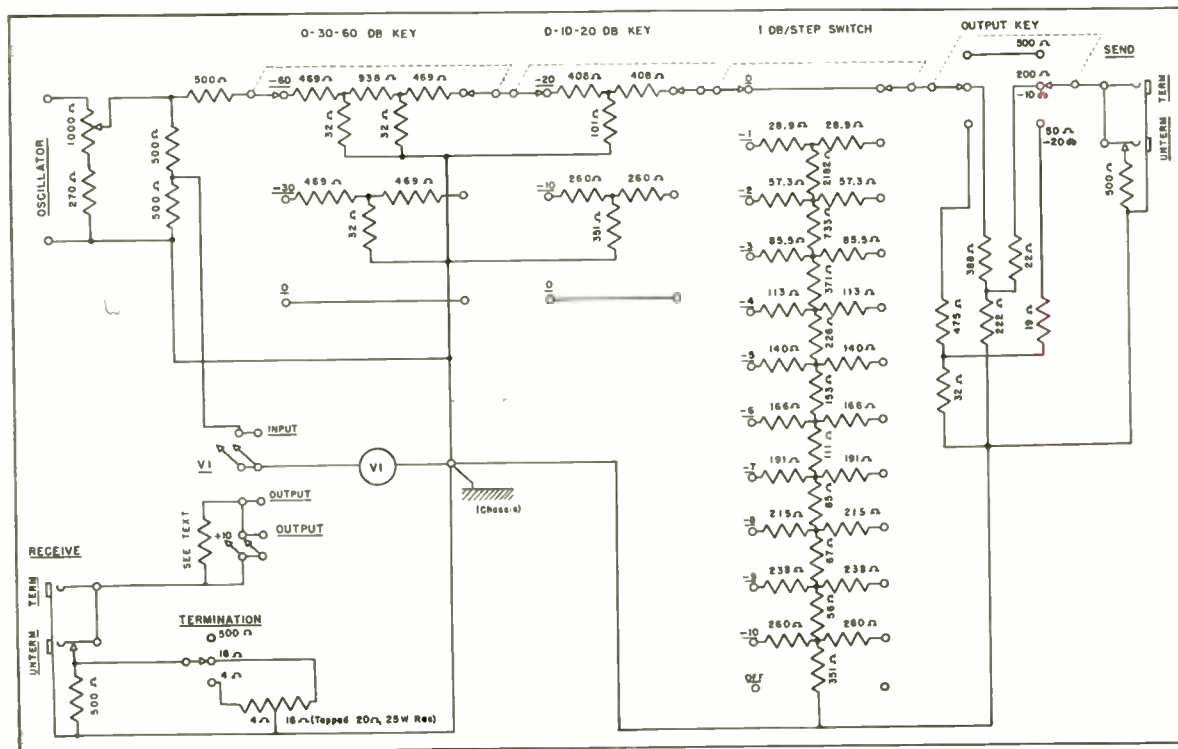

→
Fig. 5. Suggested layout for the gain set of Fig. 4.

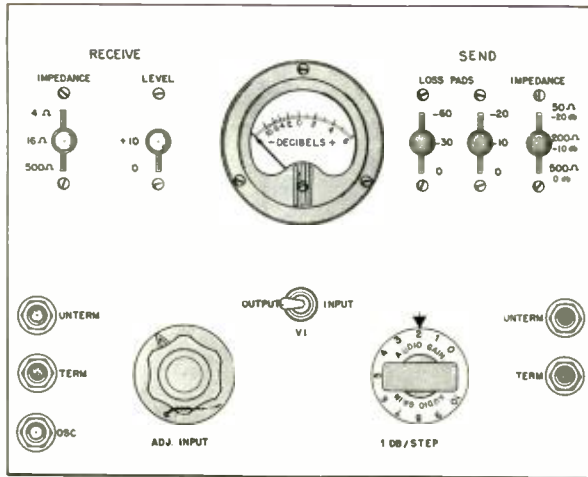
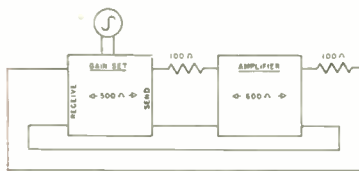

Fig. 6. Method of making measurement on 600-ohm equipment with a 500-ohm gain set.



many are available from surplus stocks at reasonable prices. The most useful calibration is $-10-0+6$, and the meter should be of the type adjusted for 6 mw across 500 ohms. This will give a known output voltage (with zero attenuation in the gain set) of 1.732 volts, and this value may be used for many measurement applications. When measuring the gain of an amplifier, however, this value is not important, since the gain is indicated directly by the switches, and the total loss in the gain set equals the gain of the amplifier.

Layout

A suggested layout for the construction of a gain set of this type is shown in Fig. 5. It may be considered desirable to combine the unit with an audio oscillator, as shown in the photograph. However, it is not necessary since any available audio oscillator may be used with this unit simply by connecting its output to the OSC terminals of the gain set.

The gain set reduces the time required to make measurements on amplifiers, filters, or equalizers, and provides a simple rapid measuring tool for the experimenter or engineer. While the use of a sensitive direct-reading audio voltmeter simplifies certain types of measurements, such an instrument is not always available. The gain set provides the information with a minimum of effort, and when carefully constructed, will repeat its measurements accurately.

This instrument is designed on the basis of a 500-ohm nominal impedance. With some equipment, it is desirable to

make the measurements at 600 ohms, and in order to match the sending impedance with a 600-ohm load, a series resistor may be added, as shown in Fig. 6. This gives an increase in the output voltage available at the terminals, since the calibration is correct with a load of 500 ohms. The new load will be $600+100$, or 700 ohms, and the voltage across the output terminals is thus equal to 2.02 volts, assuming a meter indication of 1.73 volts at zero level. The 2.02-volt signal is divided between the 600-ohm load and the 100-ohm series resistor, so

that the voltage across the load is again 1.73 volts. However, for zero level across 600 ohms—with a reference of 6 mw—the voltage should be 1.9, which represents a loss of 0.8 db. Thus, when a measurement is made with a 600-ohm load and a 100-ohm series resistor, a value of 0.8 should be added to the measured gain. At the output circuit, the same arrangement should be employed for the correct termination of a 600-ohm output, with another 100-ohm series resistor, also shown in Fig. 6. This reduces the measured voltage by a factor of 5/6, and the voltage applied to the meter is 0.7 db low. Therefore, the loss in the attenuators must be decreased by this amount. Therefore, when measuring an amplifier having input and output impedances of 600 ohms, the actual gain is 1.5 db more than indicated by the attenuators, assuming that the two 100-ohm series resistors are connected into the circuit. If the output is measured at 500, 16, or 4 ohms, the actual gain is 0.8 db greater than indicated, with additional factor added for 16 or 4 ohms, if these values are used for terminating outputs of these impedances. For 16 ohms, the factor to be added is 15 db; for 4 ohms it is 21 db.

The convenience of the gain set can only be appreciated when one is available for measurements of all kinds, and once it is used, it will be considered almost indispensable for audio development work.

- This Month -

OHMEGA LABS ORGANIZED

• A new corporation, to be known as the Omega Laboratories, Inc. has been formed. This company will specialize in research, design and development of all types of electronics and associated equipment.

Mr. E. E. Crump, formerly of Bell Telephone Laboratories is president. Mr. L. L. Libby, formerly with Federal Telecommunications Laboratories is Chief Engineer.

The new corporation is an outgrowth of Kay Electric Company of Pine Brook, N. J. makers of the Mega-Sweep Sweeping Oscillator and the Mega Match. Kay Electric Company will relinquish all its special development work to the Omega Laboratories and concentrate on the manufacturing of instruments for electronic measurements. The Omega Laboratories will also be located at Pine Brook, New Jersey.

NEW CURRENT AMPLIFIER

• Tiny diamond chips, bombarded with a beam of electrons have been found to yield electronic currents as much as several hundred times as large as the original beam in pioneer experiments at Bell Telephone Laboratories. This new method of con-

trolling the flow and amplification of current may have far-reaching influence on the future of electronics.

Dr. A. J. Ahearn, who was associated with Dr. K. G. McKay in the investigation, is shown placing the mounted diamond chips in a test circuit to check their induced conductivity under alpha particle bombardment, an associated phase of the research.



Dr. Ahearn of Bell Labs.



In this department the author, who is a very well-known record critic, will review monthly record releases of outstanding technical, as well as musical, quality.

EDWARD TATNALL CANBY*

INTERIM notes on the noise suppressor (Scott). The controversy over Mr. Scott's dynamic suppressor rages ever onward, and I seem to become more involved in it. It was deposited figuratively on my doorstep when our local municipal station, over which I broadcast an air version of the Record Revue, suddenly took it into its head to install the Broadcast Model before all of their other new transcription equipment had arrived. Before I knew what was happening I found not only all of my records being suppressed (and I mean that literally) but my voice as well! Fortunately that state of affairs was temporary, since the suppressor was not connected up or operated correctly, but I find that at this point I am valiantly defending it against scurrilous attacks from all quarters.

Mr. Scott speaks of his device as *dynamic* and quite correctly so: it continuously changes the degree of its control according to the changes in the sound itself. But too many people have assumed that the device is thereby entirely *automatic*. It is anything but that, and Scott has surely never made any such claim. Yet apparently some broadcasting stations (and many private owners) expect to set the controls once, like some sort of an automatic pilot, and enjoy any and every kind of music, every type of record with equal ease. Moreover, many users—and engineers are included—seem to assume that the greater the degree of suppression the better results will be. An easy thing to imagine, when one starts with the idea that this device is installed for the pur-

*279 W. 4th St., New York 14, N. Y.

pose of suppressing noise—Of course, the harder it works, the better will we feel!

The truth of it is, as some of us are discovering, that, in the first place, Scott's suppressor requires intelligent attention from the operator if it is to do its best—which I maintain is very good. It cannot be set permanently at a fixed position; the average dynamic level (as distinguished, roughly speaking, from the instantaneous level) and the surface of the particular record are highly important in determining the degree of suppression desirable. For broadcasting, more care in adjustment is warranted than for home listening. The loud first movement of a symphony, for example, is likely to require a very different degree of suppression from the soft and languid second movement of the same work, where dynamic levels may be very low. In the second place, the dynamic suppressor—this is my theory—works best when used, paradoxically, at the *minimum* degree of suppression for a given situation, rather than the maximum, as so many users assume. In fact, it is my opinion that the suppressor circuits should be thought of as stand-by circuits, open at all higher volume levels and even at medium levels, operative *only* when levels begin to drop well below the mean. This may seem a strange paradox, and I can hear the acid rejoinders... "Maybe the best thing is to set it at the point of zero suppression, then lean back and enjoy the music!" Not so. But remember, the suppressor is designed primarily (as I see it) to suppress noise in abnormal situations, whether in low-level passages, high-

scratch records, or in lapses between tones, as in a piano record. A normal-or-above sound level on a record keeps the gate circuits wide open, subject only to restrictions imposed by distortion in the recording or by abnormal noise.

What are the chief complaints against the suppressor, as heard today? Tell-tale ones. First, they say the tone quality of the record is ruined, especially in new or wide range records, and via FM radio. Why? Clearly *because the suppressor is working too well*. As used only too often, the gates remain normally closed—to open only at the peaks. Instead they should be normally *open*, to close only at the valleys! (Unless the record is of very poor quality, abnormal itself.) The noise suppressor is there to suppress abnormal noise. It cannot suppress *all* record noise without some damage to the highs present in the music, and in this respect it is to be considered as a *variable* filter, that enters the circuit automatically at crucial points but does *not* stay there. For this reason, it is far better than a fixed filter.

Another very common complaint: Swishing noises, a rapid and unpleasant change of quality from bright to dull. This was the very first reaction I had to a preliminary model last spring, and I have heard the same effect on the air recently in a most unpleasant manner. No doubt about it, when the device produces this kind of sound it is no improvement. Some users are assuming that this is inevitable.

But why the swish? Again, because the suppressor is working overtime, with a vengeance. If, on a very noisy or dis-

[Continued on page 39]

Horn-Type Loudspeakers

S. J. WHITE*

Design and applications of these speakers.



PRACTICALLY all of us are familiar with the exceptional distance covered by horn-type loudspeakers. Because of their high sound output they are generally associated with outdoor installations. Horn-type loudspeakers are invariably more efficient than cone-type speakers. The directional characteristics further intensify the sound on the horn axis.

While most sound and radio technicians are familiar with the design and principles of cone type speakers, the horn or indirect radiator, as it is sometimes called, is usually taken for granted without true appreciation of its characteristics. Most technicians also know that the horn loudspeaker does not appear to have the fidelity of a properly baffled cone speaker. Where the horn type speaker is apparently lacking in low frequencies, such a lack is not inherent in the principles and is only missing because of compromise with the physical size of the horn, since the low-frequency capabilities of the horn are determined by the length of the air column and diameter of the mouth. The larger the horn, the better its low-frequency efficiency. The limit to the size of a horn projector is generally dictated by physical adaptation to the installation. But given unlimited size, a horn-type loudspeaker will surpass our best cone speakers in efficiency, flatness of response and frequency range.

Horns are associated with loudspeaking units, commonly known as driver units. The diaphragm of a driver unit is small compared to a conventional cone speaker, but this does not necessarily have much bearing on the low-frequency capabilities. The diaphragm of a driver unit is generally between two and three inches in diameter where it acts as a piston. Such a small area cannot act directly on the atmosphere without a horn because of the poor low-frequency coupling to the atmosphere. A horn is necessary so that the driver unit is uniformly matched to the atmosphere for all frequencies through

the desired transmission range. Looked at in the light, a horn may be regarded as a transformer which matches the acoustic impedance of the driver unit to the surrounding air.

Function

Early literature and patents frequently referred to horns as amplifiers or resonators. They are certainly not amplifiers, and the existence of resonances would be fatal to good reproduction. Their function is to cause the driver unit to operate at its maximum efficiency.

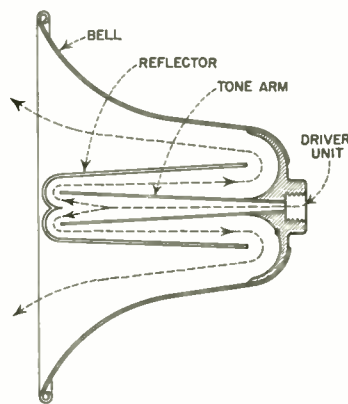

Fig. 1. Typical reflex horn consisting of three sections. Commonly available with air column lengths from one to seven feet. Dotted lines indicate sound-path. Physical length is roughly $\frac{1}{3}$ air column length.

The small end of the horn has an acoustic impedance equal to the diaphragm, while the large end possesses approximately atmospheric pressure. Uniform high radiation efficiency demands that the horn have a constant impedance at all frequencies through the audio band it is to cover. The driver unit is an "indirect" radiator because the diaphragm is incapable of delivering sound energy to the atmosphere with any efficiency.

The diaphragm works with a very small load if uncoupled from a horn. Its own natural resonance frequency will

be pronounced and the useful work performed by the diaphragm on the air will be very small. The low frequencies will be completely absent. If a driver unit is excited without a horn, the diaphragm experiences extreme excursions and the amplitude may be so great as to cause it to strike the sound head or pole piece. Yet with this great diaphragm movement, there is negligible useful sound.

A horn is, in effect, a high-pass filter. The point at which it starts to pass is its "cutoff frequency," and is determined by the flare of the horn. A very low cutoff means a slow rate of expansion, terminating in a mouth diameter which must be at least $\frac{1}{3}$ rd of the actual wavelength of the sound at its cutoff frequency; thus it follows that a real low-frequency horn must be a large one.

Design

The design of a horn must provide a constant loading at the throat (small end) in order that the response may be uniform. If this loading or damping force is irregular with frequency, the final sound output will be irregular. Such non-uniform loading may be caused by an imperfect rate of flare, and gives rise to reflections within the horn, reacting in turn upon the diaphragm. Such conditions show up as dips in the response curve which might otherwise be flat. But a carefully designed and executed horn, when coupled to a proper driver unit, will have a flatter output than is obtainable from any other type of electro-mechanical transducer. It can be commercially held within plus or minus 2 db within its band pass range, whereas the best cone speaker will vary by plus or minus 5 db and when installed in a cabinet, the latter will be further characterized by hundreds of pinpoints of cancellations caused by reflections of the rear wave. The so-called reflexed cabinet may further contribute to low-frequency non-linearity by putting a whopper of a dip at the frequency where the rear wave is out of phase with the front wave at the port position.

A horn may be considered as a wave

* University Loudspeakers, 80 S. Kensico Ave., White Plains, N. Y.

guide which is energized by the diaphragm of a driver unit, and has such shape whereby the flow of energy through the guide and into the air is not influenced by conditions giving rise to wave reflections. The requirements for high radiation efficiency demand that the horn have a constant impedance at all frequencies above its specified cutoff.

The frequency which is equal to $\frac{M \text{ (flare factor)} \times \text{Velocity of sound in air}}{2\pi}$

is the critical cutoff frequency for the functioning of the horn. The horn does not radiate at or below this frequency. Its characteristic as a high pass filter is quite marked. The larger the value of M (rate of flare), the more rapid does the horn diameter expand, and the critical frequency occurs at higher values.

The particular low-frequency desired determines the major design considerations. This resolves itself into two factors. First, the flare characteristics of the horn (which may be regarded as part of an infinitely extended wave transmission line, the impedance of which varies according to mathematical law) and secondly, the radiating properties of the mouth. Considering now the first factor, the cut-off is built into the taper so that the cross-sectional area of the horn varies according to exponential law with the distance along the sound axis. The exponential factor M is known as the "rate of flare" and is equal to the percentage increase in area per unit length along the axis. A property of a finite exponential horn is that its transmission range is inherently limited at the low frequency end, such range terminating at the cutoff frequency. This low-frequency limit is obtained from the equation:

$$\text{Frequency of cutoff} = \frac{MC}{4\pi}$$

Where M = Flare factor
 C = Velocity of sound in air in cm. per sec.

Cooperating with the rate of flare is the area of the horn mouth, and this becomes critical near the cutoff frequency. At frequencies close to cutoff the horn mouth is called upon to maintain constant impedance and radiating efficiency into free air. There must be a minimum of reflection at the horn mouth. This is achieved if the diameter is approximately 1/3rd the length of the wave of the cut-off frequency for which the flare taper was selected. For example, if we desired a horn with a cutoff at 100 c.p.s. the flare must be such as to increase by 40% in area with each foot of air column length. This results in an exponentially sloping column which is continued until a diameter is reached meeting the following equation:

$$Dm = \frac{V}{3 Fco}$$

Where Dm = required mouth diameter in feet.

V = velocity of sound in air (approx. 1150) ft. per sec.
 Fco = cutoff frequency. (c.p.s.)
 $Dm = \frac{1150}{300} = 3.83$ ft.

Air vibration of the upper frequencies leave the horn mouth with roughly plane wave fronts, but tend to bend more as the frequency becomes lower. As cutoff is

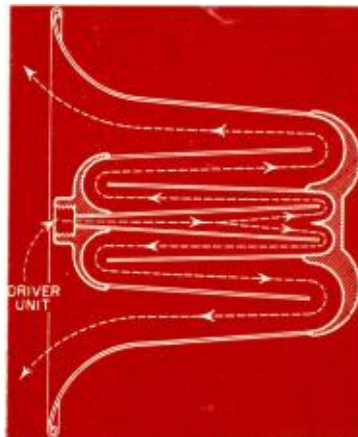

Fig. 2. A four-section reflexed horn. Dotted lines indicate sound-path. Physical length is roughly 1/4 air column length. Not very common but would be employed for exceptionally long air columns for low frequency reproduction.

reached, the emitted wave is widely diffracted and the throat impedance undergoes wide changes as serious longitudinal reflections take place within the horn.

In practical production, most of the cost of a horn is contained in the material which forms the mouth, especially toward the rim. For this reason, practically all the manufacturers terminate in a mouth diameter which is considerably less than the one-third wavelength called for by the rate of flare. The mouth diameters of all horns available today follow a one-quarter or less rule. This disparity between flare rate and mouth diameter raises the cut-off frequency and places one or more dips or steps in the normal low frequency roll-off, demonstrating erratic loading in the cut-off region.

Conical Horns

Conical horns with linearly sloping walls have been used, and in these the increase of diameter from throat to mouth takes place by equal amounts per unit length along the sound axis. Calculations and tests have proven that a finite conical horn is inferior to an exponential horn in the low frequency range. However, a reasonable compromise is obtained when two-thirds of the horn is conical, and the final third (toward the mouth) has an exponential flare.

An exponential horn is one in which

there is a constant percentage increase in area per unit length. In an exponential horn, the area at a distance X from the throat is given by the equation:

$$A_2 = A_1 \times 2.718MX$$

Where A_1 = area at throat
 A_2 = desired area at distance X
 M = flare constant

When the factors for the conical and exponential horns are plotted, it is found that above the cutoff frequency the exponential horn rapidly reaches its ultimate resistance, whereas a conical horn does so very gradually. The superiority of the exponential horn lies in this fact. Actually, to speak of "cutoff" in a conical horn of normal length is fallacious because there is no sharply defined frequency at which the acoustic resistance undergoes a sharp discontinuity. However, manufacturers of reflex or folded horns are tending to employ conical sections for the small diameter, or inner, members of the horn, because these can be economically fabricated on metal cutting or bending machines and lend themselves to mass production. Exponential sections must be individually spun on a spinning lathe, either from tubing or a disc of metal, and their production is relatively slower. The outer member, forming the bell or mouth must have an exponential flare and is therefore spun to shape.

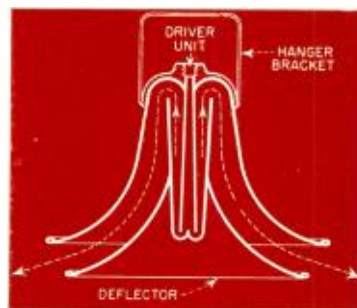

Fig. 3. Radial reflex loudspeaking horn. When suspended from ceiling will give 360 degree distribution. However, the area directly underneath the deflector must not be regarded as "dead," except for very high frequencies.

Reflex Horns

From all the above considerations it is apparent that a long air column with a wide mouth is required to transmit efficiently down to a substantial low value. However, such great lengths are awkward and difficult to handle. Skilled design has reduced the physical length of horns, without reducing the air column, by folding such horns. The reflex horn is quite old in conception, but unfounded prejudices against their efficiency withheld their appearance on the market until about ten years ago. Many reflex forms have been shown, but the one in common use today is that in which the sound conduit is re-entrantly

folded twice. That is, the horn is internally folded so that the air column reverses itself by 180 degrees twice. Thus the physical length of the horn is approximately 1/3 the air column length. The popular reflex horns today have a flowerlike appearance, containing in their center what may resemble the flower's pistil.

As shown in Fig. 1, the reflex horn contains essentially three sections, the innermost which connects acoustically with the driver unit, is known as the "tone arm." Surrounding this is the center member called the "reflector," and the final and largest member is the "bell." Each section is tapered to give the degree of expansion required to provide the desired cutoff. Generally, the rate of expansion is uniform for all three members, but this may be varied in minor extent for each section in order to modify the throat impedance characteristic. However, with a correctly designed driver unit, it is preferable to maintain uniform rate of flare. The mouth of each inner section is accurately spaced from the adjoining reflecting member by a discreet amount determined by the dimensions at this point and the cutoff frequency. Since each mouth directs its sound against a curved wall, the sound is reversed or flexed back in the opposite direction between its own wall and the surrounding member. As stated, currently popular reflexed horns, with air columns up to 6-1/2 feet long have air conduits which are reversed twice within three horn sections. Fig. 2 illustrates a horn which is reflexed three times within four horn sections.

In order to obtain a horn capable of dealing with frequencies down to 30 cycles, the area of the horn would have to double every two feet of length. Assuming we start with a throat diameter of 1 inch, this horn would have an air column about 30 feet long, and the bell mouth would be approximately 12 feet in diameter! While no such horn is con-

Fig. 5. Relationship of dispersion angle to frequency.

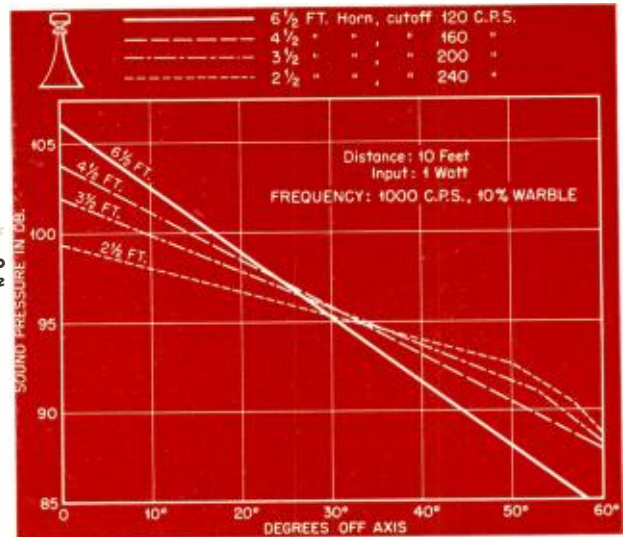

templated by any manufacturer, it could be possible to produce it in reflexed form with an over-all length of about 6 feet.

In large size reflexed horns there is a tendency for cancellation of the extreme high frequencies because of flare differences around the bends. Where these bends have a large radius, as is the case in the final bend of a large horn, phase displacement occurs because of the difference in linear distances between opposite walls of a bend. When this distance approaches 1/4 wavelength or more, acoustic cancellation sets in. Reflexed horns today are capable of reproduction to about 8,000 cycles, and as this represents the limit of the average driver unit, a folded horn may be regarded as equal to a straight horn, and has the advantages of compactness and improved protection from the weather. Reflexed horns have been designed capable of transmission to over 15 kc. Except for precise research and upper high frequency studies, the reflex horn fills all requirements for speech and music

reproduction down to its specific low frequency cutoff. The long, straight horn has entirely disappeared from the market.

The Radial Reflexed Horn

"Radial" loudspeakers refer to sound projectors which supposedly have a 360 degree horizontal distribution pattern. Speakers of this type are suspended from the ceiling and are sometimes referred to as "chandelier" speakers. As available commercially today, they are simply directional horns with a "deflector" mounted in the mouth to deflect the sound radially away from the mouth. Thus, when hung vertically, the sound is distributed horizontally through 360 degrees. Actually, in the case of such a radial, the mouth is now formed by the rim of the bell and the rim of the deflector, thus the sound axis is no longer the horn axis. The sound axis of a radial speaker lies on a plane with the mouth axis. Because the spacing between rim of the bell and the rim of the deflector (forming the mouth) is usually under six inches and hence only a fraction of the wavelengths of the low and middle frequencies, serious bending of the wave front in a vertical plane takes place. The resulting radiation has the shape of a toroid or doughnut, expanding outward in all directions. This diffraction phenomenon completely upsets the belief that the area immediately underneath a radial is a "dead" area. The area above and below is very much alive, and is more often than not, the location of maximum sound intensity. Along the vertical center axis, at right angles to the mouth axis, there is a focal "line" of diffracted waves, and since this position can be the only one at which all waves arrive in phase, it receives the summation of all energy originating circumferentially at the mouth. If feedback in a public address system is to be held to a minimum,

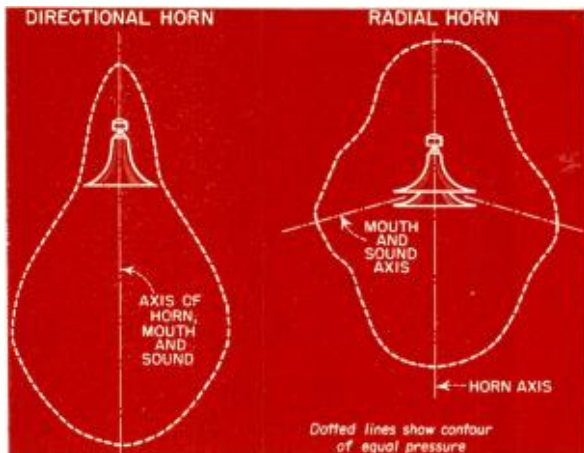
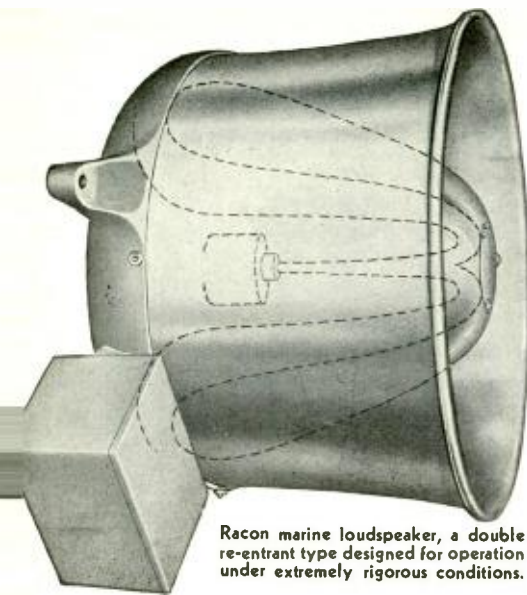

Fig. 4. Sound patterns of directional and radial loudspeakers.



Racon marine loudspeaker, a double re-entrant type designed for operation under extremely rigorous conditions.

the microphone must *not* be placed directly underneath a radial speaker. This precaution is stated here because the writer has seen claims that such a location is a dead area.

In a straight, or reflexed directional horn, the sound axis is the same as the horn axis. The sound intensity is greatest along the horn axis, becoming weaker away from the center axis. Nevertheless, a certain amount of diffraction occurs even in the case of a supposedly directional horn and such diffraction reaches a summation at the rear of the horn along the center axis. Here, however, it is considerably weaker than energy in front of the horn, but the point which it is desired to make is that the diffracted waves, weak though they be, arrive in phase on the rear center axis. There is accordingly greater sound pressure here than is attained at a point at right angles to the axis for the same distance from the mouth. This is shown in Fig. 4.



Fig. 6. Speech type horn loudspeaker designed for railroads, mines and hazardous locations. It has a throat diameter of 2½ inches, an air column length of only 8 inches, is characterized by wide dispersion angle.

Conventional radial loudspeakers afford radiation in a three-dimensional area. As such they can be regarded as omnidirectional radiators. When the dimensions are small they are the closest approach to a point source of sound. However, for practical applications this class of projector may result in the distribution of sound into directions which represent a waste of power. For example, there is as much sound directed at the ceiling as at the floor. Also, the sound pressure output of a radial is about 10 db lower than a directional horn for the same input power and distance. The answer to a true pancake-shaped pattern is a radial with a mouth opening of at least two feet, and a bell and deflector diameter of 6 feet or more. Tied to this severe size of mouth area is the concomitant slow rate of flare. The merit in current models of radial horns lie in their practicality in affording wide coverage with minimum loudspeakers, ease of installation and wiring. They generally permit a more economical installation. Radial projectors are also effective in reducing echo in highly reverberant locations.



New model of Atlas 15-inch air column of re-entrant type speaker complete with driver unit, especially fitted for paging and talkback circuits.

Some control of the radiation pattern of a radial may be had by the direction of the mouth. Where the sound (mouth) axis forms a downward plane, the lower area will receive somewhat more energy than the area above the speaker. However, there is a definite limit to this because as the mouth axis becomes more and more divergent towards the floor, it assumes the characteristics of a conventional horn which is hung downward.

The Cobra Horn

This is a popular term given to a horn whose mouth is oblong-shaped. Its design is intended to provide wide angle distribution in a preferred plane, usually horizontal. However, while the sound beam may be widened in the plane of the wider mouth axis, there is nevertheless a strong component along the narrow axis. Here again the explanation, as in the case of radials, is due to diffraction or bending of the sound wave because of the narrow width of the horn mouth. In several current models this width, that is, the narrower one, is 2 to

4 inches, and since this (in the case of the 4" width) corresponds approximately to one-third of the wavelength of a 1,000 c.p.s. tone, all frequencies below this are diffused in the plane of the narrow axis. In the case of a cobra horn whose mouth is only 2" wide, this diffraction would be effective from 2,000 c.p.s. down to the horn cutoff frequency.



Fig. 7. Driver unit type loudspeaker by University designed for coupling to a horn.

Such a horn may be compact and actually have a wide angle, but it operates with poor efficiency, since a large part of its energy has been dissipated vertically. Thus in order to achieve a required sound intensity over a given angle, more amplifier power must be used than required by two conventional round-mouth speakers, angularly displaced, to cover the same area.

Directivity of Horns

The dispersion angle of a given horn will depend upon the emitted frequency. The higher the frequency the narrower the dispersion angle. Conversely, for a given frequency, the dispersion will be sharper as the horn length is increased or cutoff frequency is lowered. The larger horn will produce greater sound pressure on its axis than a short horn, but this pressure will fall off angularly at a faster rate than in the case of the short horn. This is true for frequencies well removed from cutoff. See Fig. 5.

For frequencies considerably above cutoff (of the shorter horn) a short horn will have uniform total radiated efficiency with a long horn. Thus if the output for both a short and a large horn are averaged over an extreme angle, the results will be almost identical. Figure 5 shows the experimental results obtained with four horns of different lengths terminating in mouth diameters corresponding to one-quarter of their respective cutoff wavelengths. Along the center axis of the horn, the efficiency is proportional to horn length, demonstrating that the longer the horn the more the "channeling" effect. However, as we depart angularly from the center axis, the rate at which the pressure drops is greatest for the longest horn.

[Continued on page 34]

Vented Loudspeaker Enclosures

F. E. PLANER, Ph.D.,* and I. I. BOSWELL*

Design and performance data on aperture-type enclosures.

THE principle of the vented loudspeaker enclosure or reflex type cabinet, first described by Thuras¹, is now well known, and enclosures of this type are to-day widely used in high quality sound reproducing systems. Briefly, a vented enclosure sound system consists of a cone loudspeaker mounted in a felt-lined enclosure, which communicates with the atmosphere via an aperture or duct in the front panel. The capacitive reactance of the air volume in the enclosure and the inductive reactance of the aperture or duct are arranged to resonate at the bass resonance frequency of the loudspeaker.

Advantages

One of the main advantages of systems of this type is the improved efficiency at low frequencies, due to the re-radiation of the sound energy from the rear of the loudspeaker diaphragm via the aperture or duct after phase reversal. Other advantages are the improved transient response and reduced voice coil travel due to the additional loading of the diaphragm by the impedance of the acoustic system, as well as the relative independence of the performance from local acoustic conditions, such as the position of the enclosure in the room.

The design principles for vented enclosures, using apertures², as well as ducts³ as the inductive reactances, have already been treated in some detail in the literature. These notes will be concerned mainly with the discussion of the necessary volume of such enclosures.

The main drawback of the vented enclosure, as compared with alternative methods, such as the infinite baffle or the labyrinth type of enclosure, is the relatively large size required for the reproduction of the lowest audible frequencies. In the course of the design of a new domestic sound system in-

tended to give exceptionally high quality reproduction, the question of cabinet size became of some importance, and an investigation of the relation between size and resonance frequency was made. As a result of this a number of expressions were developed which may be of general interest.

Fig. 1 shows schematically an enclosure comprising an effective air volume V_L and a duct having length l and cross-sectional area A . The two design principles for vented enclosures which have in the past been found to give satisfactory results, state that the resonance frequency of the enclosure itself should

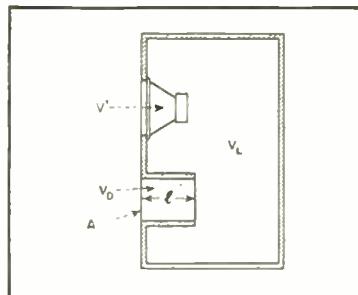

Fig. 1. Cross section through vented loudspeaker enclosure.

be similar to the bass resonance frequency of the loudspeaker, and the aperture or duct area A should be similar to that of the effective radiating surface of the speaker.

The inductive reactance in the case of an enclosure employing a duct may then, with close approximation, be written

$$x_L = \omega \rho / (\sqrt{VA} + l/A) \text{ mech. ohms... (1)}$$

where ω is the (angular) resonance frequency $= 2\pi f$ and ρ the density of air.

The capacitive reactance of the air volume is given by

$$x_C = \rho_c / \omega V_L \text{ mech. ohms... (2)}$$

where c is the velocity of propagation of sound in air.

Resonance occurs when

$$x_L = x_C \text{..... (3)}$$

Equating (1) and (2), and solving for ω the resonance frequency is found to be

$$\omega = c / \sqrt{V_L (\sqrt{VA} + l/A)} \text{..... (4)}$$

Effect of Duct Length

From this it is apparent that if the length l of the duct increases, the enclosure volume V_L may be decreased, other conditions remaining unaltered. At the same time, however, the total volume V_T which is made up of the effective air volume V_L , the volume displaced by the loudspeaker V' and that of the duct V_D , will not alter at the same rate, owing to the increase in the volume displaced by the duct.

$$\text{Since } V_T = V_L + V_D + V' \text{..... (5)}$$

and $V_D = Al$, the total volume may be written

$$V_T = A (c^2/\omega^2 (\sqrt{VA} + l) + l) + V' \text{..... (6)}$$

Now, in order to determine the length of duct corresponding to the minimum total volume, the differential of (6) with respect to l is equated to zero

$$dV_T/dl = 1 - c^2/\omega^2 (\sqrt{VA} + l)^2 = 0 \text{..... (7)}$$

and hence

$$l_{\text{min.}} = c/\omega - \sqrt{VA} \text{..... (8)}$$

where $l_{\text{min.}}$ is the duct length required to make the total volume V_T a minimum.

The volume for this condition is found by substituting (8) in (6)

$$V_{T \text{ min.}} = A (2c/\omega - \sqrt{VA}) + V' \text{..... (9)}$$

The corresponding air and duct volumes are given by

$$V_{L \text{ min.}} = A c/\omega, \text{ and } \text{..... (10)}$$

$$V_{D \text{ min.}} = A (c/\omega - \sqrt{VA}) \text{..... (11)}$$

From these results it may be seen that it is generally possible by the correct choice of duct length, to effect an appreciable reduction in the overall size of the enclosure as compared to that required when an aperture only is used.

*Addison Electric Co., Ltd., London.

¹A. L. Thuras, Sound Translating Device, U. S. Patent 1869178, July, 1932.

²C. E. Hockstra, Vented Speaker Enclosure, *Electronics*, March, 1940, p. 34.

³F. W. Smith, Resonant Loudspeaker Enclosure Design, *Communications*, August, 1945, p. 35.

Example

To illustrate the effect of the duct length on total volume, let us consider a typical sound system using a 12" loudspeaker with a bass resonance frequency of 65 c.p.s. and an effective radiating surface of $A = 75$ sq. in. Then, substituting these values in the expression (8) the optimum duct length will be

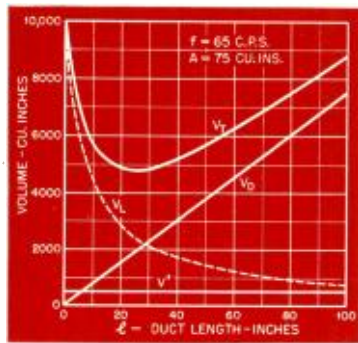

Fig. 2. Relation between duct volume, resonating air volume, total enclosure volume, and duct length for a typical vented loudspeaker enclosure.

found to be $24\frac{1}{2}$ inches, assuming the velocity of propagation of sound in air to be $C = 13,500$ in./sec. If the volume displaced by the loudspeaker is taken as 500 cu. in., then the total volume from (9) becomes $V_T \text{ min.} = 4,800$ cu. in. In comparison, the volume for an enclosure possessing an aperture only, i.e., for the case $l = 0$, is found from (6) to be 10,000 cu. ins.

The relationship between l and V_T for the above example have been plotted in Fig. 2, together with the values of V_D and V_L . It will be seen from this that as the duct length is increased there is a rapid fall in total volume, with a minimum at $24\frac{1}{2}$ in.; thereafter the total volume begins to rise at a more gradual rate. It will be noticed also that the slope of the curve for V_T is relatively small in the neighborhood of the minimum. The length of the duct may therefore, be made somewhat shorter than the optimum length indicated by expression (8) without an appreciable increase in the dimensions of the enclosure. In actual practice, it is an advantage to reduce the duct length in this manner, as it will then generally be possible to accommodate the duct without folding, thereby rendering the construction simpler and reducing the amount of wood required. Another point in favor of the shortened duct is the smaller volume taken up by the duct walls, a factor which has been neglected in the above calculations. Thus, in the present example the duct length may be reduced to 13 inches with only a 10% increase in total volume above the theoretical minimum.

Apart from its effect on the over-all size of the enclosure, the extension of the

aperture into a duct is desirable also for other reasons. Since the vent may be regarded as effectively constituting a second source of sound, it is advantageous to locate the latter as closely as possible to the loudspeaker from the point of view of the combined radiation impedance, as well as for the purpose of concentrating physically the source of sound. While these considerations apply to frequencies in the neighborhood of the resonance frequency of the enclosure, at higher frequencies the vent will tend to reduce the effectiveness of the baffle owing to the air leak created around the diaphragm of the loudspeaker. By the introduction of a duct it becomes possible to maintain the efficiency of the baffle at the higher frequencies due to the increased path length between front and rear of the diaphragm, while at the same time retaining the feature of close proximity between the two sources of sound at the lower frequencies.

In order to investigate the effect on the characteristics of the system when the ratio of duct length and air volume are varied, it is instructive to consider the equivalent electrical circuit of the mechanical system comprising the loudspeaker diaphragm and the acoustic resonator. Fig. 3 is a simplified equivalent network in which the dissipative

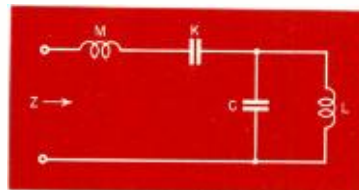

Fig. 3. Equivalent electrical circuit of mechanical system.

elements due to radiation and frictional losses have been omitted.

The vibratory system of the diaphragm comprising the stiffness of the suspension and the mass of the moving parts including the effect of air loading is represented by the series tuned circuit having capacitance K and inductance M . The acoustic system of the vented enclosure is represented by a parallel tuned circuit having inductance L and capacitance C , dependent on the stiffness of the air volume in the enclosure, and the duct and radiation mass, respectively. The impedance Z , as measured at the terminals of the network is made up of the impedances of the diaphragm Z_L and that of the enclosure Z_E in series.

$$\text{Now, } Z_L = (1 - \omega^2 MK) / j\omega K \quad (12)$$

$$\text{and } Z_E = j\omega L / (1 - \omega^2 LC) \quad (13)$$

The total mechanical impedance, therefore, is

$$Z = (1 - \omega^2 MK) / j\omega K + j\omega L / (1 - \omega^2 LC) \quad (14)$$

Impedance Characteristics

In the absence of dissipative elements, the impedance characteristic of the two coupled circuits, as represented by the expression (14), will possess two points at which the impedance becomes zero, and the admittance infinite. The characteristic of the mechanical system is reflected in the electrical impedance characteristic of the voice coil of the loudspeaker, modified slightly by the electrical constants of the voice coil itself. This electrical impedance will be a maximum when the admittance of the mechanical system is infinite, and the electrical method of measurement, therefore, constitutes a convenient means of analyzing the behavior of the mechanical system.

In order to determine the two frequencies at which the electrical impedance will be a maximum, we substitute

$$MK = LC \quad (15)$$

in (14), since the resonant frequency of the enclosure is made equal to that of the loudspeaker, and re-arranging terms (14) becomes

$$\omega^4 - \omega^2 (2K + C) / MK^2 + 1 / M^2 K^2 = 0 \quad (16)$$

Solving for ω , the two frequencies are found to be

$$\omega_{1,2} = \omega_0 \sqrt{1 + C \left(1 \pm \sqrt{4K/C + 1} \right) / 2K} \quad (17)$$

where ω denotes the resonance frequency of the two tuned systems individually.

The relation (17) is shown in Fig. 4, plotted in terms of the ratio M/L against frequency. From this it will be seen that as the duct length is increased and the enclosure volume reduced, i. e. with increasing M/L ratio, the separation between the maxima in the impedance characteristic increases. It will readily be seen that too great a separation is as undesirable as very closely spaced impedance peaks.

A number of loudspeaker enclosures were designed in accordance with the

[Continued on page 43]

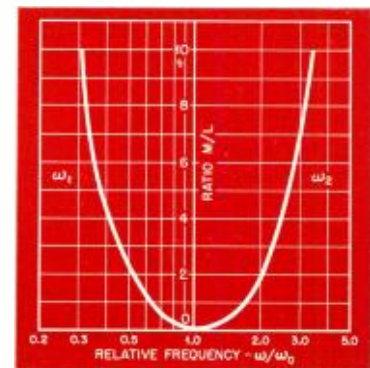
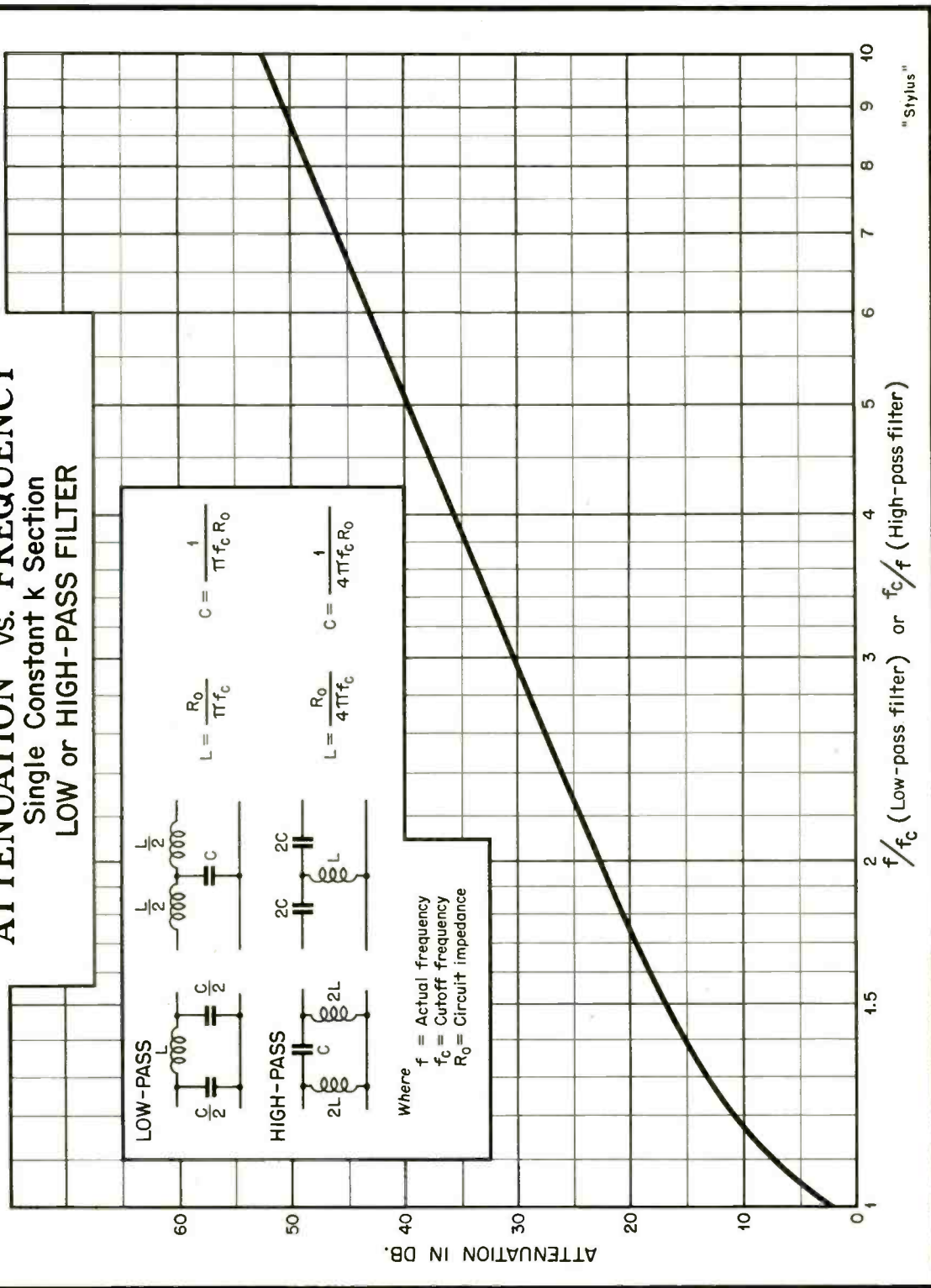

Fig. 4. Separation of the impedance maxima as a function of the ratio M/L .

AUDIO DESIGN NOTES

ATTENUATION vs. FREQUENCY Single Constant k Section LOW or HIGH-PASS FILTER



NEW PRODUCTS

TRANSFORMERS AND REACTORS

A new, complete line of transformers and reactors, for radio transmitting and receiving, PA, and industrial electronics applications, is ready for distribution by Chicago Transformer Division, Essex Wire Corporation. Included are power transformers for both capacitor input and reactor input systems, matching filter reactors, plate transformers and reactors, filament transformers, and audio transformers in a range of input, output, driver, and modulation types.



A new catalog describing the entire new line of transformers will be sent to those writing on business letterheads. Write Dept. AE-1, Chicago Transf. Corp., 3503 W. Addison St., Chicago 18, Ill.

RMC AMPLIFIERS

Radio-Music Corp., Port Chester, New York, announces a new series of Type 115 Amplifiers for broadcast monitoring, recording studios, public address systems and wired music services. Built to FM broadcast standards for low distortion, hum level, and other broadcasting requirements.

Equipped with new aural control as well as gain control. Varies volume with a flat frequency response. Aural control on

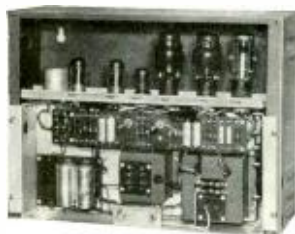

low end boosts without high end attenuation. Aural control compensates most closely to ear requirements according to location. Three-stage push-pull through-out. Simple design and rugged construction. Bulletin A 1-1 sent upon request to manufacturer.

RCA "RED SPECIAL" TUBES

RCA's new "Special Red" Tubes—5691, 5692, and 5693—are small-type tubes specifically designed for those industrial and commercial applications requiring tube features of at least 10,000 hours life, exceptional uniformity and stability of characteristics, and rigidity to resist shock and vibration. Their counterparts in the receiving-tube line are the 6SL7-GT, 6SN7-GT, and 6SJ7, respectively.

Careful and conservative design, exact processing control, and detailed inspection of each assembly provide these "Special Red" Tubes with a minimum life of 10,000

excellent stability of these new tubes.

The unique structural design of these tubes make them capable of withstanding impact shocks of 100g for extended periods.

The 5691, 5692, and 5693 are recommended in general as replacements for the 6SL7-GT, 6SN7-GT, and 6SJ7, respectively, in equipments where long life, rigid construction, extreme uniformity, and exceptional stability are needed, and where the operating conditions are within the ratings of the "Special Red" Tubes.

The "Special Red" Tubes are distinctive in appearance—the glass-octal types 5691 and 5692 have red bases and the metal type 5693 has both a red base and a red envelope.



NEW POTENTIOMETER

• Technology Instrument Corporation announces the addition of the Type RV3-5 Potentiometer to its line of precision variable resistors. This new potentiometer like others in their line has as standard features: precious metal contacts, two rotor take-off brushes, continuous 360° rotation, precision resistance winding, ganging simplicity, and dust proof construction. The important difference between this new potentiometer and others which they have previously offered, is the reduction in over-all depth, a reduction which is particularly important when the potentiometers are used in multiple ganged assemblies and when space is a factor. It has an over-all depth of 1-5/16", a power

(Continued on page 34)



hours when they are operated within their maximum ratings.

Extreme care in manufacturing combined with precision designs account for the unusually close electrical tolerances and

PROFESSIONAL DIRECTORY

C. J. LEBEL
AUDIO CONSULTANT

370 RIVERSIDE DRIVE
NEW YORK 25, N. Y.



Custom-Built Equipment

U. S. Recording Co.

1121 Vermont Ave., Washington 5, D. C.

District 1640

Winston Wells

Designer and Consultant
Acoustical and Electronic Research

307 East 44th St. MU 4-3487
New York 17, N. Y.

IMPROVED!

...to Provide a New Standard of Performance!

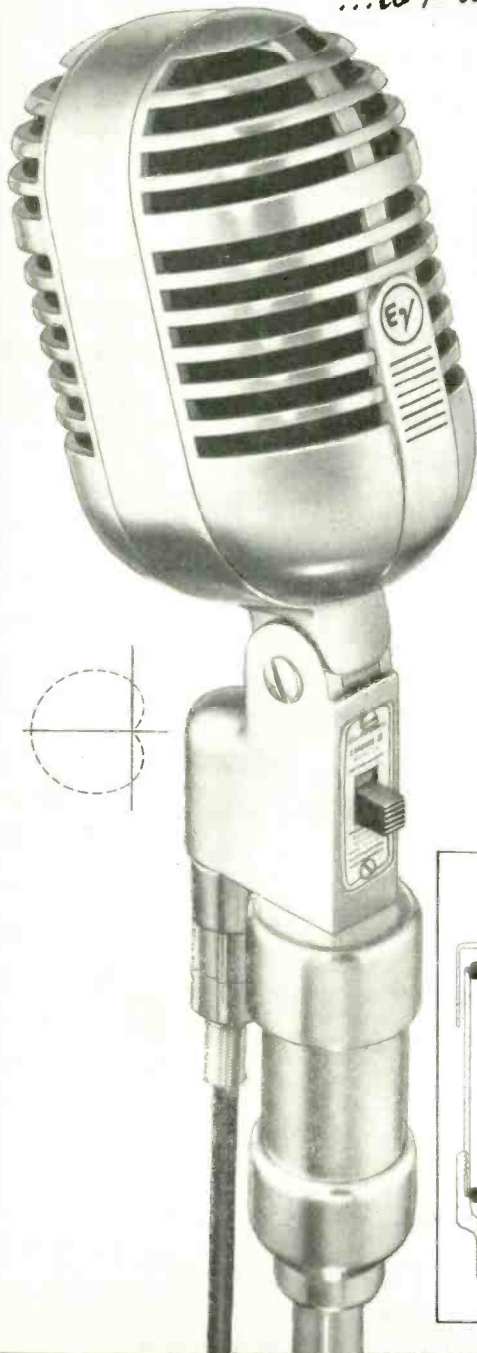

CARDYNE

Cardioid Dynamic Microphone

• It's better than ever . . . with new impedance selector . . . new external shock-mount . . . improved response . . . increased output! All this, plus Mechanophase* principle, Acoustalloy diaphragm and other great features, combines to make E-V Broadcast Cardyne today's leader!

True cardioid performance cuts reverberation and random noise pick-up . . . stops feedback . . . nearly doubles conventional pick-up range . . . provides clear, natural close-up response. Excellent for broadcasting, recording or high quality public address. Try the improved Cardyne now! *It's your best buy!*

E-V Model 731. Broadcast Cardyne II. Frequency response substantially flat 30-12,000 c.p.s. Output -50 db. Includes external shock mount. Cannon XL-3 connector. List Price \$80.00
(Also available without "On-Off" switch or with 50-250 low impedance selector.)

E-V Model 726. Cardyne I. Frequency response substantially flat 40-10,000 c.p.s. Output -53 db. Without external shock mount. MC-3 connector. List Price \$59.50

Send for Bulletin No. 139

NEW EXTERNAL SHOCK MOUNT

Model 345. Newly developed vibration isolation unit with double shock absorber action. Utilizes dual Lord shear-type mountings—eliminates undesirable vibrations transmitted from stand—reduces side sway of microphone without reducing efficiency of isolation unit. Furnished with Model 731 Cardyne. Also available separately for Model 726.

NEW IMPEDANCE SELECTOR

Recessed switch at rear of microphone case gives instant selection of high impedance (25,000 ohms) or low impedance (150 ohms). Switch easily actuated by pencil point or small screw driver. Included in both Models 731 and 726.

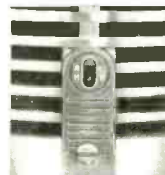

NO FINER CHOICE THAN

Electro-Voice

ELECTRO-VOICE, INC., BUCHANAN, MICHIGAN—Export Division: 13 East 40th St., New York 16, U.S.A., Cables: Arlab

New SHURE Wire Recording Heads



WR 16



WR J2



WR 14

... offer unusual versatility of mechanical and electrical adaptation



CHECK THESE FEATURES FOR EXCEPTIONAL PERFORMANCE

- 1 Versatility of playback and recording circuits.
- 2 Variety of Impedances for individual needs.
- 3 Closely controlled Air-Gaps for uniform performance.
- 4 Reduction of hum pickup.
- 5 Controlled groove contour for maximum effective position of recording wire.
- 6 Excellent wear characteristics.

Shure Patents Pending

MORE COMPLETE INFORMATION IS AVAILABLE TO FIRMS INTERESTED IN THE MANUFACTURING OF WIRE RECORDING EQUIPMENT. WRITE ON COMPANY LETTERHEAD.

SHURE

SHURE BROTHERS, INC.

Microphones & Acoustic Devices

225 W. HURON ST., CHICAGO 10, ILL. • CABLE ADDRESS: SHUREMICRO

Horn-Type Loudspeakers

[from page 28]

It will also be observed that at some off-axis position, the output of a long horn becomes identical with a short horn for a specified frequency. In the case of the horns tested this is roughly 30 degrees from the center axis. Beyond this angle the shorter horn tends to exceed the longer horn in output. In the actual test the total integrated energy of each horn over an included angle of 120 degrees was found to be identical within 1 db when tested at 1000 cycles warbled tone.

From the foregoing, it is clear that to achieve a desired angular coverage in a



Fig. 8. Radial type loudspeaker giving 360 degree distribution of sound.

sound installation where both music and speech reproduction is required, more horns of lower cutoff must be employed than would be necessary where only speech reproduction is required. Speech type reproducers possessing short air column lengths are therefore characterized by wide angles of dispersion. Figure 6 shows such a loudspeaker with an air column of only 8 inches and having a useful spread of 150 degrees.

New Products

[from page 32]

rating of 5 watts and is available in nine standard resistance values ranging between 100 ohms and 50,000 ohms. Standard models have an accuracy of $\pm 5\%$ of total resistance and an accuracy of $\pm 1\%$ can be supplied for those applications in which accuracy of total resistance is of importance.

Additional information may be obtained from Technology Instrument Corp., 1058 Main Street, Waltham 54, Mass.

NEW ENGINEERING BULLETIN

The first issue of the Amphenol Engineering News, a monthly bulletin, is now

WHAT
MAKES A GOOD
RECORDING BLANK
GOOD?
?

PREPARATION OF RECORDING LACQUER

Quite apart from the chemistry of good recording lacquer are the mechanics of tailoring it to the coating process and to the requirements of the disc itself.

Control of coating uniformity and elimination of objectionable outer-edge ridge demand, among other things, laboratory-accurate viscosity control. The correct amounts of solvent must be mixed into daily supplies of new lacquer. Electric agitators then so thoroughly stir this mixture that uniform viscosity is assured throughout the entire system. There is thus no possibility of hard or soft spots on any Soundcraft disc.

Because the high viscosity of fine-grain lacquer retards natural dispersal of air bubbles, *forced* debubbling methods are necessary. Soundcraft combines two methods, each of which alone is usually considered adequate. First, the lacquer is subjected to vacuum: second, it is allowed to rest. This double debubbling removes not only the visible bubbles, but also the noise-making *invisible* ones.

Commercial lacquer ingredients often contain hard foreign particles dangerous to styli. While the larger of such particles are commonly removed by conventional cloth and paper filter presses, Soundcraft uses two additional stages of filtering—first, coarse porous stone filters, then fine ones right at the point of coating—to trap microscopic particles even as small as one micron.

Elaborate preparation to be sure, but what better way to assure a good recording every time?

**No. 5 of a series *Watch this space for succeeding ads on how Soundcraft discs are made.*



REEVES **Soundcraft** CORP.
10 EAST 52nd STREET • NEW YORK 22, N. Y.



The 'Broadcaster' The 'Playback' The 'Audition' The 'Maestro'
AUDIO ENGINEERING MAY, 1948

distributed. Featured are stories describing a new antenna that receives television stations in all 13 channels and compact cathode ray tube sockets prewired for immediate assembly. Future issues will describe latest products in detail.

You can be placed on the mailing list by writing American Phenolic Corporation, 1830 South 54th Avenue, Chicago 50, Ill.

H-P OSCILLATOR

The new -hp- Model 650A Resistance Tuned Oscillator provides audio measurement speed, ease and accuracy for readings at r-f, video and audio frequencies. The new instrument is specifically designed to make faster, simpler and more precise the engineer's measuring job.

NEW C-D CATALOG

• Cornell-Dubilier's new catalog No 200, will prove to be a handy reference book and complete capacitor listing, as well as offering the usual ordering service.

It is a 24-page catalog, illustrated with detail drawings as well as halftones of more than 20 different classes of capacitors manufactured by C-D. Each kind is described in detail both as to construction and service and illustrated. Many also are supplemented by the working drawings. In addition, each type is listed with its construction details and list and net prices.

Catalog No. 200 may be obtained by writing to Cornell-Dubilier Electric Corporation, South Plainfield, N. J.

Loudness Control for Reproducing Systems

[from page 12]

the calculated full-section transmission shown by the circles on Fig. 2. Figure 5-B shows the complete loudness control including the terminating network. The exact image impedance can only be obtained by an infinite number of additional sections, but the elements shown are entirely adequate. The impedance level of the control is determined when R_1 is chosen. This choice will be influenced by the effects of parasitic capacitance in the switching, the desirability of using RMA values for the elements, and the amplifier to be used as a drive for the control.

Amplifier Problems

The problem of the amplifier can be analyzed as follows: consider first that the amplifier has zero internal resistance. The removal of the first shunt arm (shown connected by dotted lines in Fig. 5-B) will not affect the voltage at the input to the network, nor the transmission through it. The load presented to the amplifier is now made up of the first two series resistors, which total R_1 , plus the balance of the network. This remainder has an impedance which varies from a very high value at low frequencies to R_1 at frequencies above 1000 cps.

When the amplifier has a non-zero internal resistance, two alternatives are available. If R_1 may reasonably be made ten times the magnitude of the amplifier resistance, the amplifier can be considered to have effectively zero resistance, and the network may be reduced by leaving off the first shunt arm. An attempt at this procedure may lead to a value of R_1 which is too large for the parasitic capacitances that will be present in the switching. In this event, R_1 may be adjusted so that the amplifier resistance is any convenient fraction of R_1 . The network is now augmented: the first shunt arm is made the same as the others, and the difference between R_1 and the amplifier resistance is inserted between the amplifier and network input. In the special case of an amplifier resistance equal to $0.586 R_1$, the added resistance is $0.414 R_1$, and an extra loudness interval is available at the amplifier terminals. This arrangement is illustrated in Fig. 5-C; it will be seen that one 3 db loudness interval is inside the amplifier, and so cannot be switched out. If R_1 were adjusted to equal the amplifier resistance, the added resistance is zero; in this case, there is a 6 db loudness interval inside the amplifier.

The network elements may be mounted on a two-deck wafer type switch with

**Proved in Millions
of Applications!**



**RELAYS
RESISTORS
RHEOSTATS**

Vast Variety of Stock Units
ANSWERS EVERYDAY NEEDS ECONOMICALLY

Relays are available from stock in general-purpose, industrial, and radio amateur types for continuous or intermittent duty.

Vitrohm wire-wound Fixed Resistors are available in 8 stock sizes from 5 to 200 watts. Adjustohms in 7 stock sizes from 10 to 200 watts. Plaque Resistors in 3 sizes from 20 to 125 watts. Discohms in 18 watts. Stripohm in 5 stock sizes from 30 watts to 75 watts. Ring-type close control Rheostats in 4 stock sizes from 25 to 150 watts. (Plate Type Rheostats recommended for larger sizes.) Wide variety of Resistance Values.

AUTHORIZED DISTRIBUTORS EVERYWHERE
WARD LEONARD ELECTRIC COMPANY
Radio & Electronic Distributor Division
53-R West Jackson Blvd., Chicago 4, U. S. A.

SEND FOR HELPFUL CATALOGS
Catalog D-30 gives complete data and listings on stock units available in Resistors, Rheostats and Radio Amateur Relays. Catalog D-20 lists Industrial and General-Purpose Relays. Write for them today!



WARD LEONARD

Basic 3R's in Current Control

Now Available...

New, important additions to the most complete line of Speakers and Driving Units made

To the more than 60 different type and size speakers and horn units that already comprise the RACON line—these new models have been added. There is a RACON speaker and horn unit ideal for every conceivable sound system application.

RACON has not only the most complete line, but also the most preferred line. For over 20 years leading Soundmen have recognized and specified them because of dependability, efficiency and low-cost, and because the reproducers are trouble proof.

Here is a partial list of the various types of RACON products now available:

PM Horn Driving Units, 10 types	Straight Trumpets, 21 types	Re-entrant Trumpets, 7 types	Re-entrant Fone Speakers, 7 types
Tweeter & High Frequency Speakers, 3 types	Flat bell straight trumpets, 2 types	Armored Cone Projectors, 7 types	
Radial Horns and Speakers, 3 types			

In addition there are cellular and auditorium horns, inter-com, paging, monitor, and dwarf speakers, cone speaker housings, etc., besides all basic accessories such as swivel brackets, mounting units, cone housings, multiple horn throat combinations, etc.

Write for free catalog

RACON ELECTRIC CO., INC.

52 East 19th St.

New York 3, N. Y.

RACON



NEW SPECIAL PM HORN UNIT, having Alnico V magnet ring, completely watertight, housed in a heavy aluminum spinning. Provides extremely high efficiency reproduction with minimum input. Handling capacity 35 watts continuous, 60 w. peak.



NEW SMALL RE-ENTRANT HORNS, extremely efficient for factory inter-com and paging systems; for sound trucks, R.R. yards and all other industrial installations where high noise levels are prevalent. Watertight, corrosion-proof, easily installed. Two new models — type RE-1½, complete with Baby Unit, handles 25 watts, covers 300-6000 cps; type RE-12, complete with Dwarf Unit, handles 10 watts, freq. response of 400-8000 cps.



NEW RADIAL RE-ENTRANT SPEAKER, excellent for all types of industrial sound installations. Provides superlative and complete 360° speech intelligibility by efficiently over-riding factory high noise levels. Frequency response 300-6000 cps. Handling capacity 25 watts continuous, 35 w. peak. Has mounting bracket. Size 12" wide by 12½" high.

shorting contacts. One deck is used for switching, and has the resistors of the series arms mounted between terminals. The capacitors of the shunt arm are mounted between corresponding terminals of the two decks. Shunt arm resistors and terminating elements are then arranged on the circular area of the second deck with a ground termination in the center. The moving arm of this deck should be removed. Constructed in this fashion, the loudness control does not require an excessive mounting space.

A representative network is one which has the basic element values:

R_1	50,000 ohms
R_2	200,000 ohms
C_1	0.00355 μ f

Values which approximate the individual network components are:

.586 R_1	30,000 ohms
.414 R_1	20,000 ohms
.500 R_2	100,000 ohms
2 C_2	.0068 μ f
5.85 R_1	300,000 ohms
3.08 R_1	150,000 ohms
2.8 C_2	.010 μ f

A loudness control built with these elements, and driven from a low impedance source, has the measured characteristics shown in Fig. 6. The several approximations made in the design, as well as the element deviations, have but small effect on the over-all performance.

It will be recognized that this control is accurate only in producing appropriate changes in intensity. To be correct on

an absolute basis, each program to be reproduced should be adjusted by a resistive control elsewhere in the system so that with the loudness control at the top position, the acoustic intensity is equal to that of the original sound. This adjustment is rather impractical. Nevertheless, when the loudness control is simply used as a replacement for the ordinary resistive volume control, quite gratifying results are obtained. The most conclusive evidence of the superiority of this loudness control over flat intensity control is that a low level of intensity in the reproduction of music is as enjoyable as the higher level usually required for good tonal balance.

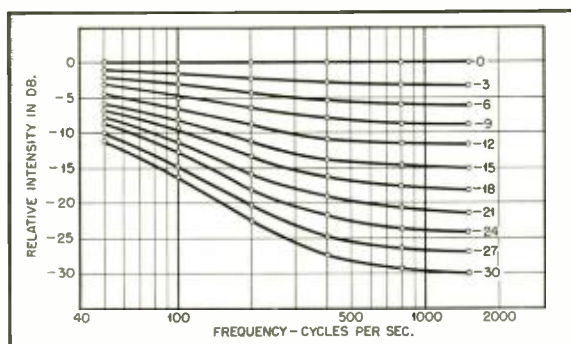

Fig. 6. Measured characteristics of loudness control constructed from data supplied in this article. It closely approximates hearing curves.

Classical Recordings

[from page 24]

torted record you set the controls so that the gates are closed most of the time, except for peaks, and the range control so that when the gates do open up, the range is quite wide, you are bound to get noise or record distortion superimposed on every peak, and especially in a piano record, or orchestral record with sudden powerful peaks or climaxes. If, on the other hand, the controls are correctly set so that the gates are open, as already suggested, for all normal volume levels and closed only when the

AUDIO ENGINEERING

BINDERS \$2⁵⁰

- Backbone gold stamped with Audio Engineering and year.
- Center channel to keep magazines fastened in position.
- Round corners, hinges and backbone fully reinforced.
- Rich blue Dupont Fabricord—stainproof and washable.
- \$2.50 postpaid. Foreign orders add 50c.

« « « Here at last is a binder using modern postwar materials at prewar prices. Designed to provide instantaneous reference to your monthly copies of Audio Engineering. An unusually fine library finish that will stand up under constant use.

- Rigid backbone with bound-in metal support.
- Light weight tarnishproof aluminum ends.
- Coil springs built in at each end to securely position spring steel wire holders.

RADIO MAGAZINES, INC.

342 MADISON AVE.
NEW YORK 17, N. Y.

AUDIO ENGINEERING
BINDERS

1947 1948

Enclosed find \$..... for..... Binders

Name.....

Address.....

City..... State.....

level is definitely below average, the swishes will be absent. True enough—there will be some more scratch. But the music will be on a level keel, the operation of the gates will coincide more accurately with the ear's capabilities, cutting the highs out only at low levels, where the ear's response to highs cuts

[to page 40]

RECORD LIBRARY

In this spot a continuing list of records of interest will be presented. The list specifically does not suggest "the" best recordings or versions. It will draw predominantly but not entirely from postwar releases. All records are theoretically available, directly or on order; if trouble is experienced in finding them *Audio Engineering* will be glad to cooperate. Records are recommended on a composite of musical values, performance, engineering; sometimes one, sometimes another predominates but records unusually lacking in any of the three will not be considered. Number of records in album is in parenthesis.

French Modern—sharp, colorful, sophisticated; good antidote for the heavyweight symphonic.

Ravel, Valses Nobles et Sentimentales; "Daphnis and Chloe" Suite No. 1. San Francisco Symphony, Monteux...

Victor DM 1143 (4)

Ravel, Bolero. Paris Conservatory Orch., Munch

Decca London

EDA 33 (2)

Debussy, Danse Sacree; Dance Profane.

Ravel, Introduction and Allegro. Marcel Grandjany, harp; Victor String Orch. Levin

Victor DM 1021 (3)

Debussy, Three Orchestral Nocturnes: "Nuages;" "Fetes;" "Sirenes" (with women's chorus)

Victor DM 630

(1 10", 3 12")

Ravel, Concerto for the Left Hand (piano & orch.) 1931. R. Casadesu, Philadelphia Orch.

Columbia MX 288 (2)

Debussy, Sonata No. 2 (harp, viola, flute) 1915. Laura Newell, M. Katims, J. Wummer

Columbia MX 282 (2)

Roussel, Petite Suite, opus. 39. Paris Conservatory Orch., Munch

Decca London

EDA 37 (2)

Milhaud, Suite Francaise. New York Philharmonic, Milhaud

Columbia X 268 (2)

Ibert, Divertissement. Boston "Pops" Orch., Fiedler. (From Musical Comedy, "Italian Straw Hat")

(in **Victor DM 324**)

(4 sides)

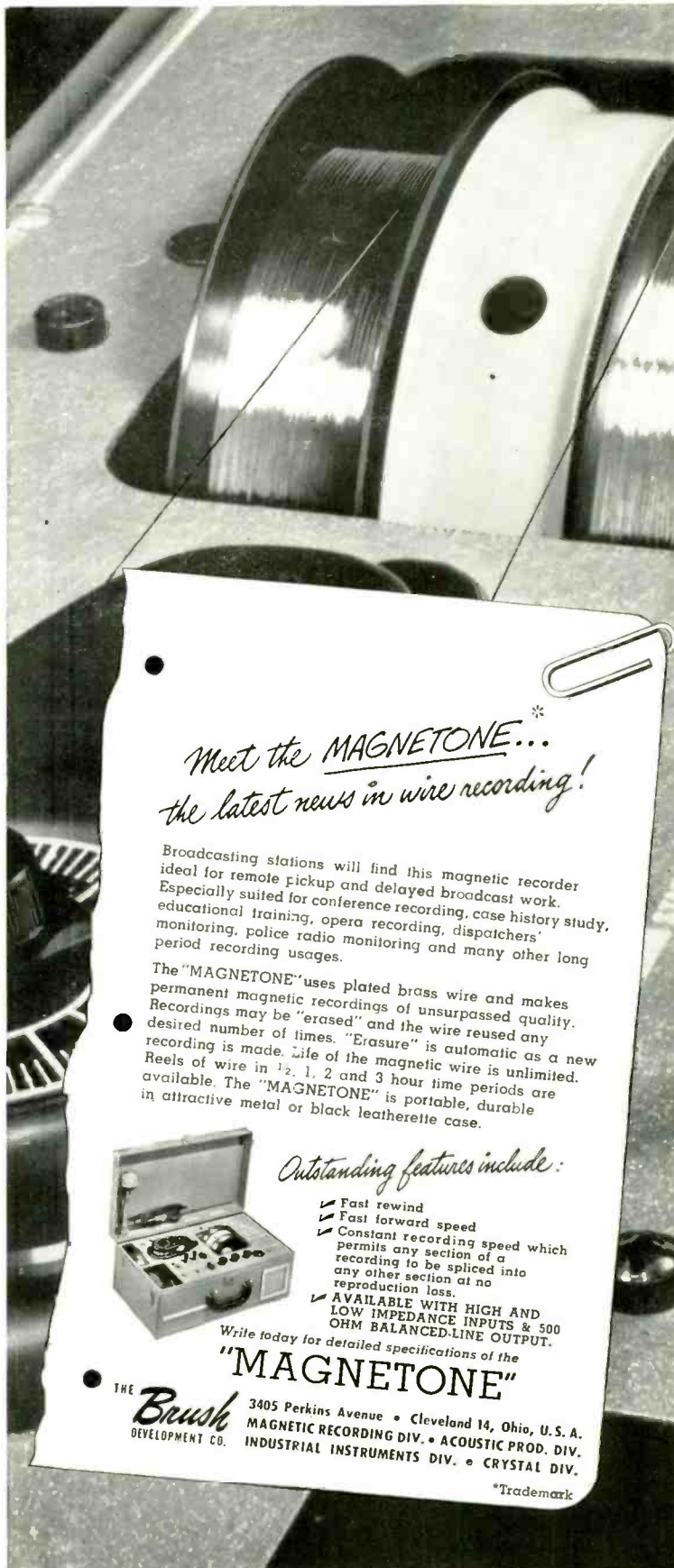

Meet the MAGNETONE...
the latest news in wire recording!

Broadcasting stations will find this magnetic recorder ideal for remote pickup and delayed broadcast work. Especially suited for conference recording, case history study, educational training, opera recording, dispatchers' monitoring, police radio monitoring and many other long period recording usages.

The "MAGNETONE" uses plated brass wire and makes permanent magnetic recordings of unsurpassed quality. Recordings may be "erased" and the wire reused any desired number of times. "Erasure" is automatic as a new recording is made. Life of the magnetic wire is unlimited. Reels of wire in 1/2, 1, 2 and 3 hour time periods are available. The "MAGNETONE" is portable, durable in attractive metal or black leatherette case.

Outstanding features include:

- ✓ Fast rewind
- ✓ Fast forward speed
- ✓ Constant recording speed which permits any section of a recording to be spliced into any other section at no reproduction loss.
- ✓ AVAILABLE WITH HIGH AND LOW IMPEDANCE INPUTS & 500 OHM BALANCED-LINE OUTPUT.

Write today for detailed specifications of the

"MAGNETONE"

THE **Brush** DEVELOPMENT CO. 3405 Perkins Avenue • Cleveland 14, Ohio, U.S.A.
MAGNETIC RECORDING DIV. • ACOUSTIC PROD. DIV.
INDUSTRIAL INSTRUMENTS DIV. • CRYSTAL DIV.

*Trademark

New ATLAS SOUND ALNICO-V-PLUS

A great step forward . . . Atlas Alnico-V-Plus Super-efficient magnetic assembly. Energy per unit volume over three times as great as any used before. Traditional Atlas Quality and Fidelity to Precision are incorporated in all these new developments. Keep step with Sound Advancement with Atlas Sound.



PD-8V New Atlas streamlined Hi-Fidelity Alnico-V-Plus Driver Units.

TP15V New Atlas Alnico-V-Plus Dual Projector. Also in larger model TP24V.



HU-24V All Atlas Speakers have new unbreakable Alnico-V-Plus Driver Units.

PD-5V All Atlas PD-V Driver Units are completely Magnetically Shielded . . . entirely Hermetically Sealed.



HU-15V Maximum efficiency as reproducer, utmost performance as microphone in talk-phone.



PD-3V All Atlas PD-V Driver Units have full phenolic unbreakable diaphragms.

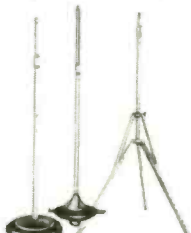

MICROPHONE STANDS—Atlas is outstanding in Quality, completeness and variety of models produced.

Write for New Illustrated Catalog.



MULTIPLE SPEAKER SUPPORT STAND

Atlas Sound's dual purpose value. Perfect for powerful outdoor (collapsible tripod model) or indoor (illustrated) array. Portable. Quick, convenient, practical.

ATLAS SOUND CORP.

1445-39th STREET
BROOKLYN 18, N. Y.

down anyway, as Scott himself points out in his demonstrations of the suppressor.

A fatal mistake, to my way of thinking, is to assume that with the suppressor operating, all external filters may be dispensed with. You may so assume, if you make a point of shifting the fixed range filters within the suppressor to match the quality of a given record. But if, for example, a scratchy record or transcription with distorted highs is played on position "A," the widest range, results will be disastrous, and particularly when the suppressor is set for maximum suppression. What happens is that on every peak the gates, closed the rest of the time, suddenly open wide, allowing the full distortion and accompanying scratch to come through momentarily, without any filtering at all. I heard a beautiful example of this recently when a poorly transcribed broadcast was played thus through the suppressor, with the highly mistaken idea that the trouble would be automatically cleared up! It was merely intensified.

With the suppressor, the maximum range must be limited to the extent that distortion and noise are not heard superimposed on the peaks. This still provides greater range than fixed filters which must be set for the quiet passages.

I suggest then, as general operating principles:

1. Pay attention to the suppressor during operation, about the amount of attention one pays to the monitoring of a radio or recorded program at the professional control board. Install the suppressor according to instructions and control modulation level after the suppressor.

2. Set the fixed maximum-minimum range control about as you would set a fixed filter—position "A", wide range, for brand-new, high quality records, position "B" for most prewar good records (which seldom have high tones above 7 or 8000) and position "C", the most restricted, for distorted, ultra-scratchy or otherwise abysmal recording. (These positions are marked numerically on the "laboratory" model suppressor amplifiers.) Do not leave this control on the wide-open position and expect suppression to do the rest, in the case of poor records. It will not! Even in the "C" position the maximum range is for wider than with fixed filters to provide equal noise reduction.

3. Adjust the variable degree-of-suppression control so that the gates begin to close only at below average levels. On music with quick peaks (piano, sudden orchestral sounds, etc.) use less suppression or restrict the

TERMINAL'S SOUND STUDIO is now demonstrating the amazing recent developments in TRUE SOUND REPRODUCTION

FEATURING SOUND EQUIPMENT FOR
Broadcast Stations Recording Studios . . . Set Builders
High Fidelity Enthusiasts . . .



WRITE FOR FREE CATALOG TODAY

See and hear the finest and latest in sound equipment. New York's leading radio and electronic distributor invites you to Terminal's uniquely equipped sound studio.

Our well illustrated catalog is yours for the asking . . . featuring the latest amplifiers, tuners, speakers, record changers, cabinets, pick-ups, phono cartridges, recordings, microphones and essential sound accessories.

TERMINAL RADIO CORP.
85 CORTLANDT STREET, NEW YORK CITY, N. Y. • WO-4-3311

maximum range, to avoid swish sounds. On smooth music you can close the gates more, is necessary. Use suppression sparingly. Save the maximum gate action for abnormal "emergencies?" let it stand by for most normal musical sound.

I am quite sure that if these principles are followed the suppressor, while no cure-all, will prove a positive asset, and most particularly in broadcasting, where scratch during low level recordings is a constant annoyance to thousands of listeners.

RECENT RECORDINGS

Mozart, Symphony No. 40 in G. Minor.
Pittsburgh Symphony, Reiner.....
Columbia MMV 727

(3 plastic)

Here are the first Columbia plastics—no excitement, thanks to publicity's worship of the "first"—which Victor copped in this case some time back. But Columbia's plastic has immediate possibilities: the Columbia recordings, with their wider range, justify the use of plastic; Columbia is sensibly using the same album numbers, same type labels, black color, avoiding the suggestion of super-deluxedness which we all know is no longer very reasonable in the plastic-vs.-shellac argument. This recording seems to have the full range of recent shellacs from the company—possibly a bit more range. Quiet surface (though no better than some small-company vinylites). Recording is somewhat dead, with, apparently, a sharp peak in middle highs. Instruments remarkably clear and sharp, but this style recording not too good for Mozart.

Bach, 8 Little Preludes and Fugues.
Ernest White, organist. (Organ at Church of St. Mary the Virgin, N. Y.)

Technicord T 10 (4)

Bach, Toccatas and Fugues, vol 1.
Carl Weinrich, organist. ("Praetorius" organ, Princeton, N. J.)

Musicraft 36 (4)
(reissued)

Organ Music of Bach.

E. Power Biggs, organist. (Organ of St. Paul's Chapel, Columbia Univ.)

Columbia MM 728 (5)

A splurge of Bach organ music, wonderful stuff for big-speaker reproduction. The White and Weinrich albums are both played on so-called "Baroque" style organs, built according to the quite different specifications of Bach's time—the greatest period of organ composition and building. They are not "big" organs, but rely on sharp, clear, independent contrasted tone colors. Bach on these organs is light, graceful, transparent, instead of dough-like.

[to page 42]

now
being used by:
DUMONT • RCA
NBC • CBS
for studio and
Location productions

**PROFESSIONAL JUNIOR
COLLAPSIBLE DOLLY**

ideal for
all types of
**TELEVISION
CAMERA
WORK**

Immediate Delivery

This Dolly designed by specialists of custom-built television and motion picture equipment, and lens mounts. Representatives for Houston Developing Machines, Auricon single system camera and recording equipment. Bardwell & McAlister lighting equipment, Moviola and Micro Engineering editing equipment. Rentals, Sales and Repairs of all types of 16mm and 35mm cameras, lighting and editing equipment.

Above—Dolly with Du Mont TV camera mounted. Below—Dolly collapsed.

Complete staff of trained technicians available for consultation.

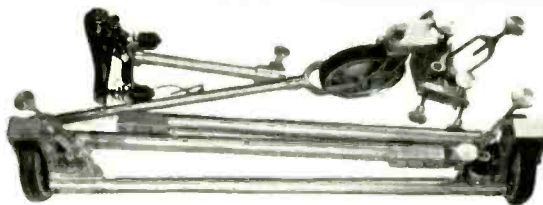

Large and sturdy, will support television camera on tripod, and cameraman. Assembles quickly without use of tools; constructed of magnesium and dural, provided with rubber tire wheels, quick-setting lock for straight line dollying. Collapses to fit carrying case. 12" sq. by 6' long.

Write for Literature

FRANK C. ZUCKER

CAMERA EQUIPMENT CO.
1600 BROADWAY NEW YORK CITY



CAN SAVE YOU MONEY

without sacrificing Quality!

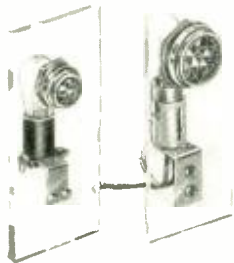

No. 300 Series (with Screw Socket and No. 60 A-3 Jewel)	No. A900 Series, DC (with Bayonet Socket and No. 75 A-3 Jewel)
---	--

REDUCE YOUR COSTS

to meet the growing demands of a competitive market with these new low-priced DRAKE items . . . but still get such features as

- UL Listing
- Availability of a variety of mountings
- With A900, positive lock to eliminate lamp loosening from vibration

And DRAKE Jewels are stand-outs, too, with—Turned brass Jewel holders—Polished chrome plate on larger diameters—Availability of both slip fit and threaded types—Choice of 28 combinations of color and finish of glass!



Get the full story on the big DRAKE line—send now for new Catalog R, just off press.

*Socket and Jewel
Light Assemblies*

DRAKE
MANUFACTURING CO.
DEPT. A, 1709 W. HUBBARD ST., CHICAGO 22

The Technichord-White album is wide-range, with excellent acoustics, live but not too live. Shellac surfaces, alas, make high highs mostly useless; but, like the piano, the organ tone color is mostly determined in low highs—removing highs makes little musical difference here. Play the records with plenty of high roll-off. The Wenrich album (Musicraft) is first of series of reissues. No highs at all, but, as above, it doesn't matter much. Bad surfaces, filterable to taste. Lovely tone colors. Chief difficulty: complete absence of reverberation—a most unnatural effect. Musicraft would do well to add artificial liveness to the succeeding albums before reissuing them.

E. Power Biggs' album reverts to the 19th century type of organ sound—big noise, big echo, most of details lost in confusion of brilliant reverberation. A gorgeous recording job by Columbia cannot make this into more than a big, powerful sound, musically most disappointing. Compare Biggs with the old Albert Schweitzer Bach recordings, if you doubt me.

Bizet, Carmen Suites No. 1 & No. 2; L'Arlesienne Suites No. 1 & No. 2. National Symphony Orch. (British); Fistoulari, Beer.

Decca London
EDA 41 (3)
EDA 42 (3)

The Carmen suites are given an unusually serious and musical treatment, in contrast to the "Pope" kind of playing, brash and noisy, that they are apt to get in the U.S.A. Soft, accurate, beautifully phrased, unassuming. The frr recording is similarly soft, though wide-range as usual, and suits the musical interpretation beautifully. Highly recommended. L'Arlesienne is more of the same, not as interesting.

Schumann, Symphony No. 3 ("Rhenish"). Minneapolis. Symphony, Mitropoulos.

Victor DM 1184 (4)

(Same Selection). New York Philharmonic, Bruno Walter.

(Columbia MM 464 (4))

In recording technique, these two are not radically different. The new Victor has slightly more high range, quite a bit more brilliance (neither rate anywhere near "wide-range"). Both are acoustically good as to liveness, musically most satisfying. But, notably in the first movement, the Bruno Walter interpretation is so immeasurably superior to the Mitropoulos that one would swear the recording was better! It is purely a musical difference. The Walter version is so tense, so real, so alive that the music seems to "live" in the

recording itself. Here is a factor no engineer can control!

Monotti, The Telephone; The Medium. (Complete operas.) Original cast of Ballet Society Broadway production.

Columbia MM 726B (3)
MM 626A (7)

Two modern but easy-to-follow operas in English, built for interchangeable production, on the stage, via radio, recording, even films (all are being tried) and highly successful in this their recorded version. Splendidly clear, wide range recording by Columbia. Voices perhaps a bit too prominent for stage-opera effect—but these operas can take it. The Telephone is a winsome and amusing satire. The Medium a stark ghost story, highly dramatic. Not available separately—but the two go down well enough together. Technically, this begins to foreshadow the "opera" of the future.

Britten, Peter Grimes; Four Sea Interludes and Passacaglia. Amsterdam Concertgebouw Orchestra, von Beinem.

Decca London
EDA 50 (3)

If you like dramatic music, frr, with a touch of the modern, try this. These are interludes between scenes of the recent British opera, now in the Met. Opera repertory. In spite

S.O.S. SPECIALS of the Month

MULTIPLE FLOOD UNIT

Four 18" Alzac Giant Reflectors with Mogul Screw Sockets for P852 lamps 750/2000 watts. Numocushion Stand Telescopes 4'8" to 8'6". Folds compactly. Head section may be hung or set anywhere. Includes cable and casters.

REG. \$225

SPECIAL \$181.25



OFF-THE-TUBE TELEVISION RECORDING CAMERA

Includes noise reduction amplifier, operates from audio output of television receiver at 30 fps, with 1/80" shutter opening. Less lens. \$1300
MITCHELL STD. CAMERA, 4 Pan Astro lenses, 2 mukaines, 2 tripods, motor, etc. \$5997.50

ADDED SPECIALS!

Kodak Cine Special Blimp	\$295.00
B & H 110V AC/DC Studio Camera Motor	249.50
Wall 35mm Studio Sound Camera, 4 lenses	1595.00
Arriflex 35mm Camera, 4 lenses, complete	995.00
WE 35mm Sound Moviola 3 way	795.00
35 mm Sound Film Recorder with new galvanometer	1995.00
Neumade 35mm Automatic Film Cleaning Machine, entirely enclosed, with motor	167.50

EVERYTHING FOR STUDIO, CUTTING ROOM & LABORATORY

Lights, Mikes, Rooms, Dollies, Lenses, Background Process, Moviolas, etc. Send for Bulletin Strelab—thousands of good buys!

S.O.S. CINEMA SUPPLY CORP.

Note New Address, occupying entire building:

Dept. AE 602 West 52nd St., New York 19

of modernism, the music is impressionistic, moody, hence widely attractive. Recording soft, mellow, wide range. Quiet passages, as usual, are very low level, but surfaces are better than most.

Walton, Portsmouth Point Overture. Minneapolis Symphony Orch. Mitropoulos.....

Columbia
12755-D(1)

A sassy single from Columbia—recording is an astonishing contrast to the same orchestra, now with Victor, as heard in the Schumann above; wide range, but decidedly dead, rather harsh. This is not the best of Columbia's technique and the Victor job, highs or no highs, is much preferable. However, multiplicity of fancy instrumental effects here and ultra-clarity make it worthwhile trying on good equipment. Heavy bass (low turnover).

Brahms, Quartet No. 3 in B flat, opus 67. Quiet Quartet.....

Vox 208 (4)

A beautiful performance of a quartet not hitherto recorded. This is an interesting example of a recording that technically should be classed as poor, but thanks to peculiar combination of factors, is actually a very good one, generally speaking. Two big factors are excellent liveness and fine performance. No higher highs, but a well-placed boost, apparently, in mid-highs, plus the fine liveness, gives a wide range impression—may fool many engineer listeners. Considerable distortion in highs still doesn't spoil the effect! High level; wide dynamic range.

Vented Enclosures

[from page 30]

foregoing considerations, and a complete sound system employing these principles was constructed. The loudspeaker enclosure is the central unit and incorporates an 18" exponential cone loudspeaker having a bass resonance frequency of 40 c.p.s., a medium frequency driver unit with multicellular horn, and a special wide-angle distribution electrostatic high-frequency unit together with suitable dividing networks. Allowance has been made in the calculations for the additional volume taken up.

The associated apparatus is housed in the two separate side cabinets. These apparatus units have been designed so that when they are used together with the loudspeaker enclosure as illustrated, the acoustic performance will be enhanced by the horn loading effect of the exponentially shaped surfaces of the side cabinets.

[to page 44]

Studio Quality AMPLIFIERS

WITH CUSTOM-BUILT FEATURES

Design of Bardwell & McAlister's New Commercial Amplifiers embodies the principles which have been proven in custom-built units developed in the Motion Picture Industry, where quality is requisite. Fully licensed.

12w. models operate up to 8 indoor speakers, effectively cover outdoor audience of 2500.

25w. models operate up to 16 indoor speakers, effectively cover outdoor audience of 8000.

Designed & fabricated by manufacturers of high quality Sound & Recording Equipment for the Motion Picture Industry. Union made.

2 to 4 high gain input channels and 2 to 4 high or low gain radio or phonograph input channels.

High fidelity reproduction at any setting of volume controls up to full rated output with less than 4% distortion.

Frequency response flat within 1/2 db from 50 to 10,000 cycles.

Output impedances 500, 250, 16 & 8 ohms. Overall gain 105 db. Hum level 85 db below full output.

With or without professional "T" type bass and treble equalizers.

Write today for informative catalog & Technical data.
Dealer inquiries invited.

12



ELECTRONIC DIVISION
BARDWELL & McALISTER, INC.

BOX 1310, HOLLYWOOD 28, CALIFORNIA

ONE STANDARD
OF QUALITY
ONLY...THE
HIGHEST



DEDICATED TO
THE CONSTANT
BETTERMENT
OF SOUND

1161 N. VINE ST., HOLLYWOOD 38 • 250 W. 57th ST., NEW YORK 19

INDUSTRY WELCOMES HIGH QUALITY OF IMPROVED ALTEC LANSING LINE

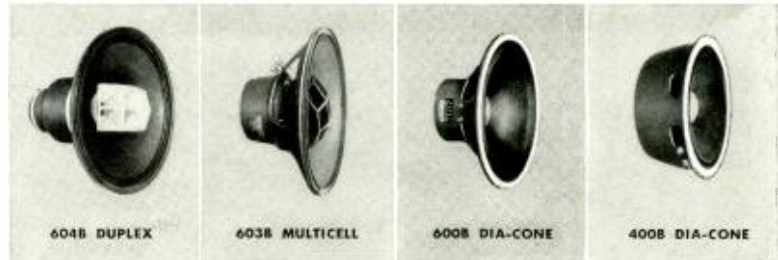

Altec Lansing scientists who developed the revolutionary new improvements in speaker design presented in the new Altec Lansing line of speakers are overwhelmed by the response of quality-conscious engineers throughout industry to the remarkable improvement in efficiency, smoothness of frequency response, and performance of the new speakers. Although the consensus of industry opinion placed the previous Altec Lansing speakers in the front rank of high quality speakers, the new line of Altec Lansing speakers, basically re-engineered and fundamentally improved, has immeasurably widened the gap between Altec Lansing performance and the performance of even remotely comparable speakers.

SEND FOR BROCHURE

An illustrated brochure describes the new line of Altec Lansing speakers in detail, shows exact, dependable, scientifically accurate frequency response curves. Use address nearest you: Altec Lansing Corporation, 250 West 57th St., New York 19, or 1161 North Vine St., Hollywood 38. Write Dept. 52

FOR ENGINEERS ONLY!

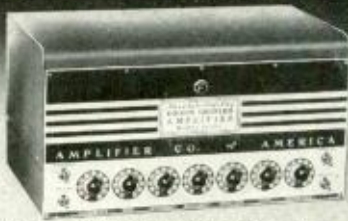

Specifications that speak for themselves

1. Push-pull direct-coupled driver stage
2. Self-balancing, drift-correcting circuit
3. Automatic dynamic balancer
4. Push-Pull triode expanders (introduce less than 1½% distortion at full 20 db. expansion.)
5. No interstage transformers
6. Exclusive non-frequency discriminating scratch suppression circuit
7. Overall gain 94 db. (High gain model 117 db)
8. Guaranteed ± 1 db. at 20 to 20,000 cycles
9. Independent push-pull high and low frequency equalizers
10. Enlarged, 83 db. dynamic range (less expansion)
11. DC on heaters assures exceptionally low noise and hum (-48 dbm.)
12. Input stages employ anti-microphonic construction
13. Regulated fixed bias
14. Automatically delayed plate voltage
15. Balanced output transformer
16. Automatic hum balancer continuously cancels hum
17. Balanced power feedback increases dynamic stability
18. High condenser safety factor
19. No shielded wire in input circuit assures extended high frequency response
20. Models available with built-in pre-equalized pre-amplification for GE and other low level pickups.

Send for Technical Literature

AMPLIFIER CORP. of AMERICA

398-4 BROADWAY

NEW YORK 13, N. Y.

Model EA-2 AUDIO COMPENSATOR



Zero Insertion Loss OR 25 Db Gain

WITH NO AXIS SHIFT

This compensator is designed for use where audio equalization is required. It is applicable in film recording, disc recording and general broadcast studio work. The unit consists of a two stage "RC" amplifier using type 1620 tubes. Standard input and output impedances are available.

The equalizer can be switched during a take with no switching clicks or mid range gain shift. This distortion free low noise level equalizer includes the most modern features. The high frequency switch and the low frequency switch have a flat position, three positions of raise and three positions of lower, giving 8 db of equalization and 16 db of attenuation at both ends of the audio spectrum.

(Send For Brochures with Curves)

ARLINGTON ELECTRIC PRODUCTS, Inc.

18 WEST 25th STREET

NEW YORK 10, N. Y.

Watkins 9-8961

[from page 43]

Tests

A number of acoustic and electrical measurements have been carried out on enclosures of this type in order to study their characteristics. In the first instance it was necessary to verify that the resonance frequency of the acoustic system coincided with that of the loudspeaker. For this purpose, the voice coil current was measured at various frequencies with the loudspeaker removed from the enclosure and in free air.

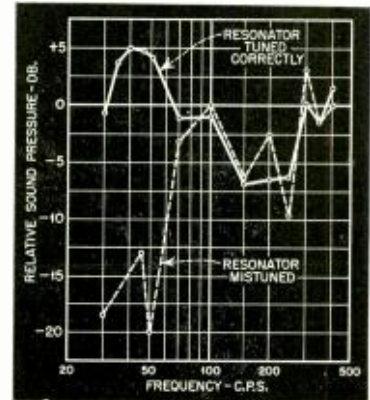

Fig. 5. Relative sound pressure at mouth of duct with the acoustic resonator tuned correctly, and mistuned, respectively.

The baffle opening for the speaker was then blocked, and a corresponding volume introduced to replace that of the speaker. The acoustic system was subsequently excited by means of a separate driver unit coupled to the air volume in the enclosure by means of a tube 3 feet in length and 3/8ths in. in diameter. This precaution was necessary in order to avoid interaction between the vibratory system of the driver unit and the acoustic resonator.

The tube was introduced via the duct, and the driver unit fed from a beat frequency oscillator. A microphone was placed immediately at the mouth of the duct, and together with its associated detector amplifier, served to indicate the resonance frequency of the enclosure. It was found in each case, that the actual resonance frequency of the enclosure was lower by varying amounts, than the calculated value, and an adjustment in the duct length was necessary in order to make the resonance frequencies of loudspeaker and enclosure coincide.

Next the loudspeaker was restored, and measurements were made of the sound output from the duct by means of the microphone and detector amplifier. Fig. 5 shows two typical characteristics obtained for the sound pressure at the mouth of the duct, with the latter tuned correctly, and with the acoustic system mistuned, respectively. (40 cycle enclosure).

Among other measurements the elec-

trical impedance characteristic of the voice coil was determined over the useful frequency range under operating conditions. For this purpose the voice coil was connected in series with a decade resistance box, and the combination fed with signals at various frequencies from a beat frequency oscillator. By adjusting the decade resistance until the voltage drops across it and the voice coil were equal, the value of the impedance at the particular frequency could be read from the setting of the resistance box. By these means it was in each case verified that instead of the original single peak, the impedance characteristic now possessed two damped resonance peaks, the frequencies of the two maxima being approximately 31 and 55 c.p.s. in the case of the 40-cycle enclosure referred to in Fig. 5. This separation is regarded as quite satisfactory and has been considered to be one of the reasons for the exceptionally smooth response of the system.

Reverberation System

[from page 17]

continuity along the air column. Tape was also used here to seal against possible leaks.

In addition to those already described, equalizer (3) was provided for this circuit branch, which was placed ahead of the loudspeaker driver. The computed insertion loss characteristic of this equalizer by itself is shown in Fig. 11.

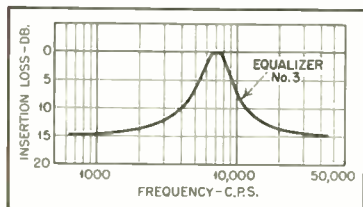
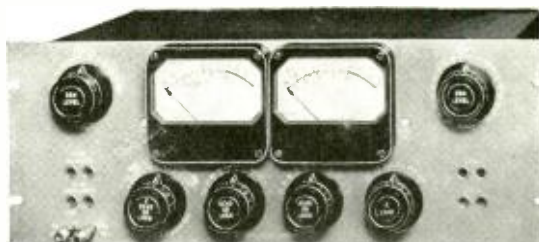

Fig. 11. Insertion loss characteristics driver equalizer (No. 3).

The various acoustical coupling and equalizing elements described were selected mainly by the cut-and-try method, observing the result of any change on the frequency response of the branch. A sweep-frequency audio oscillator is, therefore, a necessity in work of this nature; with it, the effect of any change can be noted instantly on the screen of a scope connected to the output. Tedious point-by-point measurement was resorted to only when greater accuracy was desired.

Figures 12, 13 and 14 are photographs of the units comprising the channel. The first is of the reverberation bay in the main equipment room. At the top are the four microphone preamplifiers, then an 82A amplifier, control panel, jack strip, more 82A amplifiers, metering switch and the power supply at the

FOR PRECISE AUDIO MEASUREMENTS



CINEMA TYPE 4983 TRANSMISSION MEASURING INSTRUMENT

This unit was designed to make precise measurements of circuit gain, loss and power level. Special attenuator design and circuit layout minimizes leakage at the higher frequencies and makes possible a guarantee of 0.2% accuracy over the range between 30 and 17,000 cycles.

An important feature is the use of *Balanced H* type attenuators and matching networks to obtain absolute circuit balance to ground.

The oscillator input transformer is placed directly ahead of the transmission attenuators. The transformer response is within 0.1 db. from 20 to 20,000 cycles and the distortion is less than 0.1% over the entire range of the instrument.

SPECIFICATIONS

Attenuation Range:—

Transmission: -106 to plus 26 db. in steps of 1 db.

Load Network: Plus 4 to plus 42 db. in steps of 2 db.

Accuracy: Component resistors within plus or minus 0.5%.

Frequency Characteristic: Plus or minus 0.2 db. between 30 and 17,000 cycles.

Impedance Ranges: 30, 150, 250, 500 and 600 ohms. (balanced)

15, 150, 250, 500 and 600 ohms. (unbalanced)

Meters: Weston Model 802, Reference level 1 mw, 600 ohms.

Mounting: Rack panel, 7 inches high.



CINEMA
ENGINEERING COMPANY
1510 W. Verdugo Ave. Burbank, Calif.
Cable Address: CINENG BURBANK



KEEP POSTED ON ELECTRON TUBES

Use this convenient coupon
for obtaining the RCA tube
reference data you need.

RCA, Commercial Engineering,
Section EW-65 Harrison, N. J.

Send me the RCA publications checked below. I
am enclosing \$..... to cover cost of the books
for which there is a charge.

Name _____
Address _____
City _____ Zone _____ State _____

- Quick-Reference Chart, Miniature Tubes (Free). [A]
- HB-3 Tube Handbook (\$10.00)*. [B]
- RC-15 Receiving Tube Manual (35 cents). [C]
- Receiving Tubes for AM, FM, and Television Broadcast (10 cents). [D]
- Radiotron Designers Handbook (\$1.25). [E]
- Quick Selection Guide, Non-Receiving Types (Free). [F]
- Power and Gas Tubes for Radio and Industry (10 cents). [G]
- Phototubes, Cathode-Ray and Special Types (10 cents). [H]
- RCA Preferred Types List (Free). [I]
- Headliners for Hams (Free). [J]

*Price applies to U. S. and possessions only.



TUBE DEPARTMENT
RADIO CORPORATION of AMERICA
HARRISON, N. J.



The Best ...
HIGH FIDELITY
... Idea Yet—

The **BOGEN PK**
High Fidelity System

Bogen
SOUND SYSTEMS
AND
COMMUNO-PHONES



BOGEN PH10
HIGH FIDELITY AMPLIFIER



LATEST MODEL WEBSTER CHANGER



DUAL HIGH FIDELITY SPEAKER

The 10 watt amplifier is virtually humless in any position of the Multi-Range Tone Control. Speaker assembly incorporates 12" Alnico V woofer, University tweeter and cross-over network. Changer incorporates Astatic 1J cartridge plus automatic disconnection of pick-up during change cycle.

PK-1 SYSTEM

LIST PRICE \$141.60*

*Slightly Higher West of the Rockies

Write for complete
PK Story Without
Obligation. Address
Dep't. E-5.



David Bogen
CO., INC.

663 BROADWAY, NEW YORK 12, N. Y.

bottom. An enlarged view of the control panel is shown in Fig. 13. The four controls on the bottom row are the microphone faders; at the upper left is the feedback gain control while the one at the upper right is the reverberation main gain. Transfer switch S_1 is at upper center. Equalizer and filter elements, except Eq. 3, are mounted at the rear of this unit.

The coils of one-inch aluminum pipe shown in Fig. 14 have a maximum diameter of approximately five feet. Taping of the microphones was done after the photograph was made. Eq. 3 was mounted in a small aluminum box below the lower driver unit. The supporting framework shown was shock mounted to one wall of a relatively unused room, and so far no trouble has been experienced from accidental pickup of voices in the room. Each turn of pipe was isolated from the wood frame by a layer of sponge rubber. Forming the coils was easy because the tubing was quite soft.

REFERENCES

*S. K. Wolf, Synthetic Production and Control of Acoustic Phenomena by a Magnetic Recording System, *Proceedings IRE*, p. 365, July, 1941.

*P. C. Goldmark, P. S. Hendricks, Synthetic Reverberation, *Proceedings IRE*, p. 747, December, 1939.

*J. K. Hilliard, Reverberation Control in Motion Picture Recordings, *Electronics*, p. 15, January, 1938.

*H. F. Olson, Elements of Acoustical Engineering, 1940. D. Van Nostrand Co.

Magnetic Recording

[from page 19]

shows the distortion in a reproduced signal of 1000 cycles from a 0.004 inch 18-8 stainless steel wire running at four feet per second as a function of the bias applied to the recording head. Also shown is the output resulting for the bias used. The input to the head was maintained at a constant value for these data. It can be seen that for the higher values of bias considerably less distortion is generated. However, this curve does not show the reduction in high frequency response caused by the higher bias. Figure 4 is similar to Fig. 3 except that a frequency of 100 cycles was used instead of 1000 cycles. It will be seen that the shape of the distortion curve is much broader than for the 1000-cycle case. The distortion for 100 cycles is higher than that for 1000 cycles even though the same recording level was used. This is not always the case. Wires have been tested which have just the reverse of this operation in that the low frequency distortion is much lower than that at medium and high frequencies. No data is available on tape concerning

for the **FINEST**
Wide Range,
Hi-Fidelity

insist on

RACON'S
Hi-Frequency
TWEETER



● Simply connect this tweeter in parallel with your present speaker, using a cross-over network, and you will obtain perfect sound reproduction throughout the entire audible frequency range.

● RACON'S tweeter is designed so that only one unit is needed to assure optimum performance.

● Two different size Tweeters are available: One having frequency response 200 to 10,000 cps with 10 watt capacity; The other has frequency response 1,000 to 12,000 cps. with 2 watt capacity.

Write for free catalog

RACON ELECTRIC CO., INC.
52 E. 19th St. N. Y. 3, N. Y.

BUILD BETTER ELECTRONIC EQUIPMENT
with **STANDARDIZED**



for
ALL
P. A.
NEEDS

Par-Metal
Equipment
is preferred by
Service Men,
Amateurs, and
Manufacturers
because they're
adaptable, easy-
to-assemble, eco-
nomical. Beautifully
designed, ruggedly
constructed by spe-
cialists. Famous for
quality and economy.

Write for Catalog.

**READY-
TO-USE
CABINETS**
•
CHASSIS
•
PANELS
•
RACKS

PAR-METAL
PRODUCTS CORPORATION

22-42-49th ST., LONG ISLAND CITY 3, N. Y.
Export Dept.: Rocke International Corp.
13 East 40 Street, New York 16

this phenomenon but it would seem that similar operation should be found.

Again, as was the case regarding frequency response, the amplifiers associated with a magnetic recorder must be capable of handling the output and input circuits without generating appreciable distortion if the full capabilities of the system are to be realized. Because magnetic recording, when properly handled, does not generate even order distortion it would seem advisable to use an amplifier which has the same general characteristics. This tends to lead to the use of push-pull output stages at least.

Audible Beats

One factor in the design and testing of a magnetic recorder, which has not received much attention, is the production of audible beats between the recorded material and the bias frequency. This effect generally occurs at the higher audio frequencies. The spurious signals appear to be the sum or difference, or both, of the harmonics of the audio signal beating with the supersonic bias. This effect is not appreciable except at recording levels which somewhat exceed the maximum permissible level for low distortion. However, most magnetic recorders use some sort of pre-equalization in which the current in the recording head is boosted at the higher audio frequencies. The level is usually adjusted for maximum signal at some low or medium frequency and, if the input which gives this level is maintained at the higher frequencies, beats, due to overload, are nearly certain to occur. However, if the input is adjusted in accordance with the pre-equalization the beats will not be present because little or no overload will occur. If the pre-equalization is properly designed it will take into account the maximum probable energy at a given frequency and adjust the head current so that overload will not occur at any point under normal conditions.

The designer of a magnetic recorder must consider all of the above factors in working out a unit. However, many of them at this time are nearly entirely empirical and thus must be determined by trial and error methods. Thus a great deal of experimental and developmental work is necessary to arrive at a satisfactory solution.

Finally, it may be said that, in magnetic recording, as in most other things, nearly anything can be done if one just wants to do it badly enough, but sometime the desire must be extremely intense. Excellent frequency response, with low distortion and good signal-to-noise ratio may be achieved if one is willing to expend the time and effort necessary. However, the art of magnetic recording is essentially just beginning, and the means to achieve these ends are sometimes extremely difficult.

NEW...IMPROVED

PRECISION ATTENUATORS

by **TECH LABS**

TYPE
850-A 850-B



The units illustrated represent a complete redesign of our older precision attenuators for laboratory standards. Flat for all frequencies in the audio range. Reasonably flat to 200 k.c. up to 70 db.

Bulletin sent on request.

TECH
LABORATORIES, INC.

Manufacturers of Precision Electrical Resistance Instruments
337 CENTRAL AVE. • JERSEY CITY 7, N. J.

for IDEAL REPRODUCTION



GRAY TRANSCRIPTION ARM

Featherweight magnesium, frictionless motion, adjustable stylus pressure, self-leveling base.

Designed exclusively for the finest lateral reproduction, the Gray Transcription Arm accommodates all modern cartridges—General Electric, Pickering, etc.—and has been adopted for all transcription tables by national radio networks—Columbia Broadcasting System, American Broadcasting Company—and numerous independent stations. Arm, less cartridge, \$35.00.

DIAMOND GE CARTRIDGES!

We are now supplying GE cartridges selected for uniform characteristics with finest quality diamond styli mounted and wired in the Gray Transcription Arm at \$29.63 additional. The long life of a diamond stylus makes this an exceptionally economical investment.

GRAY EQUALIZER FOR GE CARTRIDGE



Standard type radio station 4-position equalizer. Pos. No. 1, flat; pos. No. 2, NAB, etc. Expertly engineered for use with the GE Cartridge. Matches pickup to microphone channel. Adopted by radio networks. Complete, \$42.50.

GRAY RESEARCH & DEVELOPMENT COMPANY, Inc.

Factory: Hartford, Conn.

Sales: 565 FIFTH AVENUE, NEW YORK 17

SPECIAL PROBLEMS

demand

SPECIAL TREATMENT

Engineering judgment is often the most important ingredient in the design and construction of apparatus for your specific needs. We specialize in —

— one-of-a-kind instruments for electronic or electro-acoustic measurements

— recording or reproducing systems with special characteristics

— subminiature audio for

Laboratory, Production Testing, Broadcast Station, Recording Studio, or Discriminating Home

Audio Instrument Company
420 Lexington Ave., New York 17, N. Y.

FREE



NEW! COMPLETE!
Concord
Radio Catalog

160 Value-Packed Pages of
the LATEST and BEST in

**RADIO • TELEVISION and
ELECTRONIC EQUIPMENT**

Write for FREE copy. Address Dept. -255

CONCORD RADIO CORP.

CHICAGO 7 901 W. Jackson Boulevard
ATLANTA 3 265 Peachtree Street
Downtown Chicago Branch: 229 W. Madison Street
LAFAYETTE RADIO CORP.

ADVERTISING INDEX

Altec Lansing Corp.	43
Amplifier Corp. of America	44
Arlington Electric Products, Inc.	44
Arnold Engineering Co.	5
Atlas Sound Corp.	40
Audio Development Co.	4
Audio Devices, Inc.	Cover 2
Audio Instrument Co.	48
Bardwell & McAlister, Inc.	43
Bogen, David Co., Inc.	46
Brush Development Co.	39
Camera Equipment Co.	41
Cinema Engineering Co.	45
Concord Radio Corp.	48
Drake Manufacturing Co.	42
Electro Motive Mfg. Co., Inc.	2
Electro-Voice, Inc.	33
Gray Research & Dev. Co.	47
Jensen Manufacturing Co.	9
Klein, Manuel	48
LeBel, C. J.	32
Par-Metal Products Corp.	46
Professional Directory	32
Racon Electric Co., Inc.	37, 46
RCA (Broadcast Div.)	Cover 4
RCA (Tube Div.)	45
Reeves Soundcraft Corp.	35
Scott Radio Laboratories, Inc.	8
Shure Brothers, Inc.	34
Simpson Electric Co.	7
S.O.S. Cinema Supply Corp.	42
Sylvania Electric Products Inc.	1
Tech Laboratories	47
Terminal Radio Corp.	40
United Transformer Corp.	Cover 3
Universal Microphone Co.	48
University Loudspeakers, Inc.	48
U. S. Recording Co.	32
Vibration Systems, Inc.	48
Ward Leonard Electric Co.	36
Wells, Winston	32
Western Electric Co.	10

Ceiling unlimited!

With the new

UNIVERSITY TWEETER



**FULL RANGE
RESPONSE TO THE
LIMIT OF AUDIBILITY**

Don't let your loudspeaker put a ceiling on the frequency response of your radio or phono equipment. Enjoy full range reproduction right up to 15,000 cycles by connecting one of these tweeters to your present cone speaker. Perfect for FM and the latest full frequency range recordings. Available in single or dual unmounted types and in walnut cabinet models. Prices from \$20.00. Write today to

UNIVERSITY LOUDSPEAKERS, INC.
80 South Kenosca Ave. White Plains, N. Y.

University Loudspeakers

**VERTICAL LATERAL
REPRODUCERS RECONDITIONED**
Types 9-A, 9-B, D-93306, M1-4856, M1-4875-G
Complete Stock of New Replacement Parts for
All Types

This service is being used by leading radio stations and wired music companies from coast to coast. Factory prices prevail.

VIBRATION SYSTEMS, INC.
1040 W. Fort St. Detroit 26, Michigan



**D61B CONSTANT VELOCITY
FREQUENCY RECORD**

Here's an indispensable guide for fast, accurate, direct checking of phono pick-ups and indirect checking of recording heads, loud speakers, p. a. equipment, etc. 18" double-faced Vinylite record. 78 RPM—recorded in 3 sections, 50-10,000 cps, 400 cps, 1,000 cps. Lists \$5.50 ea.—see your distributor or write to

UNIVERSAL MICROPHONE CO.
INGLEWOOD CALIFORNIA

WAR SURPLUS

WESTERN ELECTRIC

BRAND NEW
35 WATT



EXTRA HEAVY
DUTY UNIT

BELOW WHOLESALE COST

- Full frequency response driver unit with projector.
- Excellent for Concessions, Ball Parks, Mobile, P.A. work.
- Stock up now—never again offered at this low price.

\$24.95

F.O.B., N. Y.C.

25% deposit with order, Bal. C.O.D.
MANUEL KLEIN, 74 Cortlandt St.
New York 7, N. Y.



for High Q Inductors...

For Maximum Stability... Permalloy Dust Toroids

The UTC type HQ permalloy dust toroids are ideal for all audio, carrier and supersonic applications. HQA coils have Q over 100 at 5,000 cycles... HQB coils Q over 200 at 4,000 cycles... HQC coils Q over 200 at 30KC... HQD coils Q over 200 at 60 KC. The toroid dust core provides very low hum pickup... excellent stability with voltage change... negligible inductance change with temperature, etc. Precision adjusted to 1% tolerance.

Inductance Value	Type No.	Net Price	Inductance Value	Type No.	Net Price
5 mhy.	HQA-1	\$7.00	70 mhy.	HQB-3	\$16.00
12.5 mhy.	HQA-2	7.00	120 mhy.	HQB-4	17.00
20 mhy.	HQA-3	7.50	.5 hy.	HQB-5	17.00
30 mhy.	HQA-4	7.50	1 hy.	HQB-6	18.00
50 mhy.	HQA-5	8.00	2 hy.	HQB-7	19.00
80 mhy.	HQA-6	8.00	3.5 hy.	HQB-8	20.00
125 mhy.	HQA-7	9.00	7.5 hy.	HQB-9	21.00
200 mhy.	HQA-8	9.00	12 hy.	HQB-10	22.00
300 mhy.	HQA-9	10.00	18 hy.	HQB-11	23.00
.5 hy.	HQA-10	10.00	25 hy.	HQB-12	24.00
.75 hy.	HQA-11	10.00	1 mhy.	HQC-1	13.00
1.25 hy.	HQA-12	11.00	2.5 mhy.	HQC-2	13.00
2 hy.	HQA-13	11.00	5 mhy.	HQC-3	13.00
3 hy.	HQA-14	13.00	10 mhy.	HQC-4	13.00
5 hy.	HQA-15	14.00	20 mhy.	HQC-5	13.00
7.5 hy.	HQA-16	15.00	.4 mhy.	HQD-1	15.00
10 hy.	HQA-17	16.00	1 mhy.	HQD-2	15.00
15 hy.	HQA-18	17.00	2.5 mhy.	HQD-3	15.00
10 mhy.	HQB-1	16.00	5 mhy.	HQD-4	15.00
30 mhy.	HQB-2	16.00	15 mhy.	HQD-5	15.00



HQA, C, D
1 1/2" Dia. x 1 1/8" High.

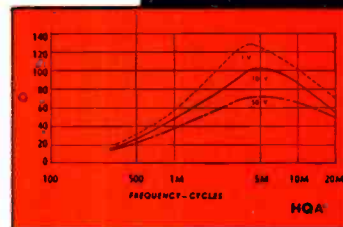

HQB
2 3/8" L. x 1 3/8" W. x 2 1/2" H.

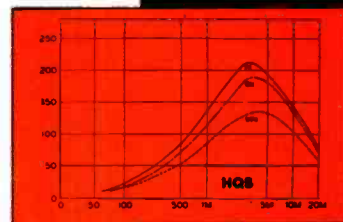

UNCASED TOROIDS
(Deduct \$1.50 for uncased units)

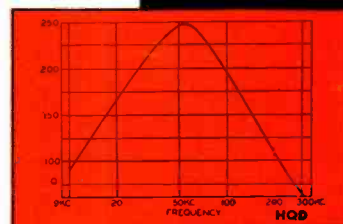
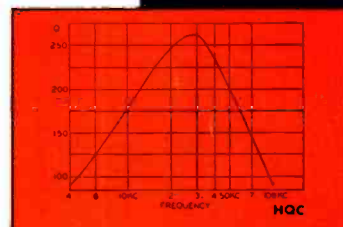

For Maximum Flexibility... The VIC Variable Inductor

The set screw on VIC units permits positive adjustment of inductance to plus 90% minus 50% from rated value. Revolutionary approach for tuned audio circuits. Q and L vs. screw adjustment for a typical coil are illustrated.

Type	Mean Hys.	List Price	Type	Mean Hys.	List Price
VIC-1	.0085	\$11.00	VIC-11	.85	\$14.00
VIC-2	.013	11.00	VIC-12	1.3	14.00
VIC-3	.021	11.00	VIC-13	2.2	14.00
VIC-4	.034	11.00	VIC-14	3.4	14.00
VIC-5	.053	11.00	VIC-15	5.4	16.50
VIC-6	.084	11.00	VIC-16	8.5	16.50
VIC-7	.13	14.00	VIC-17	13	16.50
VIC-8	.21	14.00	VIC-18	21	16.50
VIC-9	.34	14.00	VIC-19	33	16.50
VIC-10	.54	14.00	VIC-20	52	16.50
			VIC-21	83	17.50



1 3/8" L. x 1 1/4" W. x 1 1/2" H.

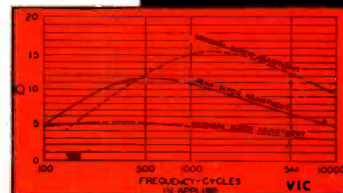
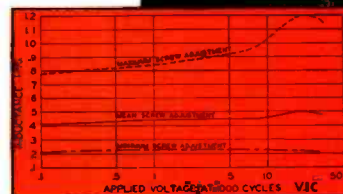

United Transformer Corp.

150 VARICK STREET

NEW YORK 13, N. Y.

EXPORT DIVISION: 13 EAST 40th STREET, NEW YORK 16, N. Y.

CABLES: "ARLAB"

Write for catalog PS-408

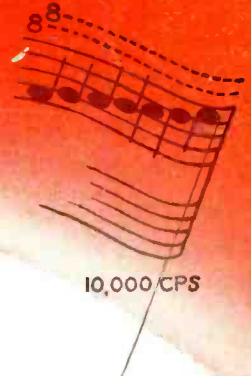

Immediate Delivery
 PRICE **\$630.00**

TYPE 70-D
 RCA HIGH-FIDELITY
 TRANSCRIPTION TURNTABLE

Standard of the Studios—NEW EDITION

Over 3000 units of this professional series are now in use

• Type 70-D is designed specifically to meet your needs for higher and higher reproduction quality in studio transcriptions.

In this unit—latest of the "70 series"—you will find all the exclusive features of the previous models . . . and important new ones. There's the universal lightweight pick-up with the diamond-point stylus . . . unexcelled for high-fidelity characteristics on either vertical or lateral recordings. And the mechanical filters and spring clutch assembly

that completely isolate the driving motor from the platter and fly-wheel assembly.

There's the heavy-duty, constant-speed synchronous motor with all the driving power you need for recording and reproducing at 33 $\frac{1}{3}$ or 78 rpm. And there's the handsome new hinged-door 'meta' cabinet with its durable formica top . . . with the inside space to house booster amplifiers and recording cueing amplifiers . . . and with accommodations on the formica top for adding an RCA

72-D or 72-DX Recording Attachment when you decide to go into recording.

For the finest response from your recording . . . for dependable timing to the very last second . . . for even running and smooth starts and stops, this studio turntable has it! Available in two cabinet-top heights . . . 28 inches and 30 inches. Equipped with convenience-plug outlets for a-c and audio circuits. Ask your RCA Broadcast Sales Engineer for complete data, or write Dept. 7-E

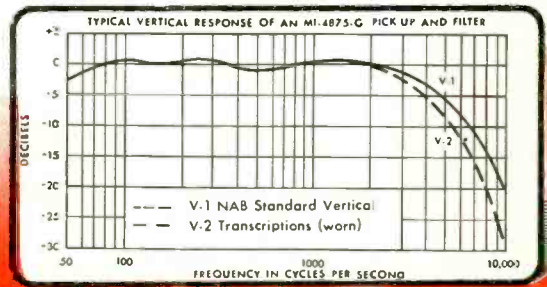
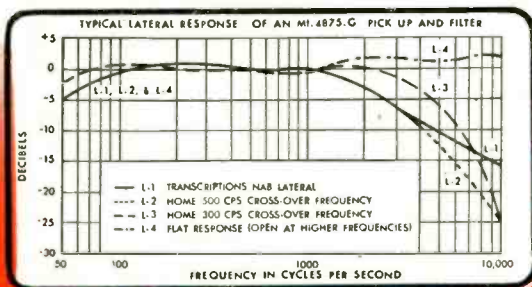

BROADCAST EQUIPMENT
RADIO CORPORATION of AMERICA
ENGINEERING PRODUCTS DEPARTMENT—CAMDEN, N.J.

In Canada: RCA VICTOR Company Limited, Montreal