

AUDIO ENGINEERING

OCTOBER
1950
35c

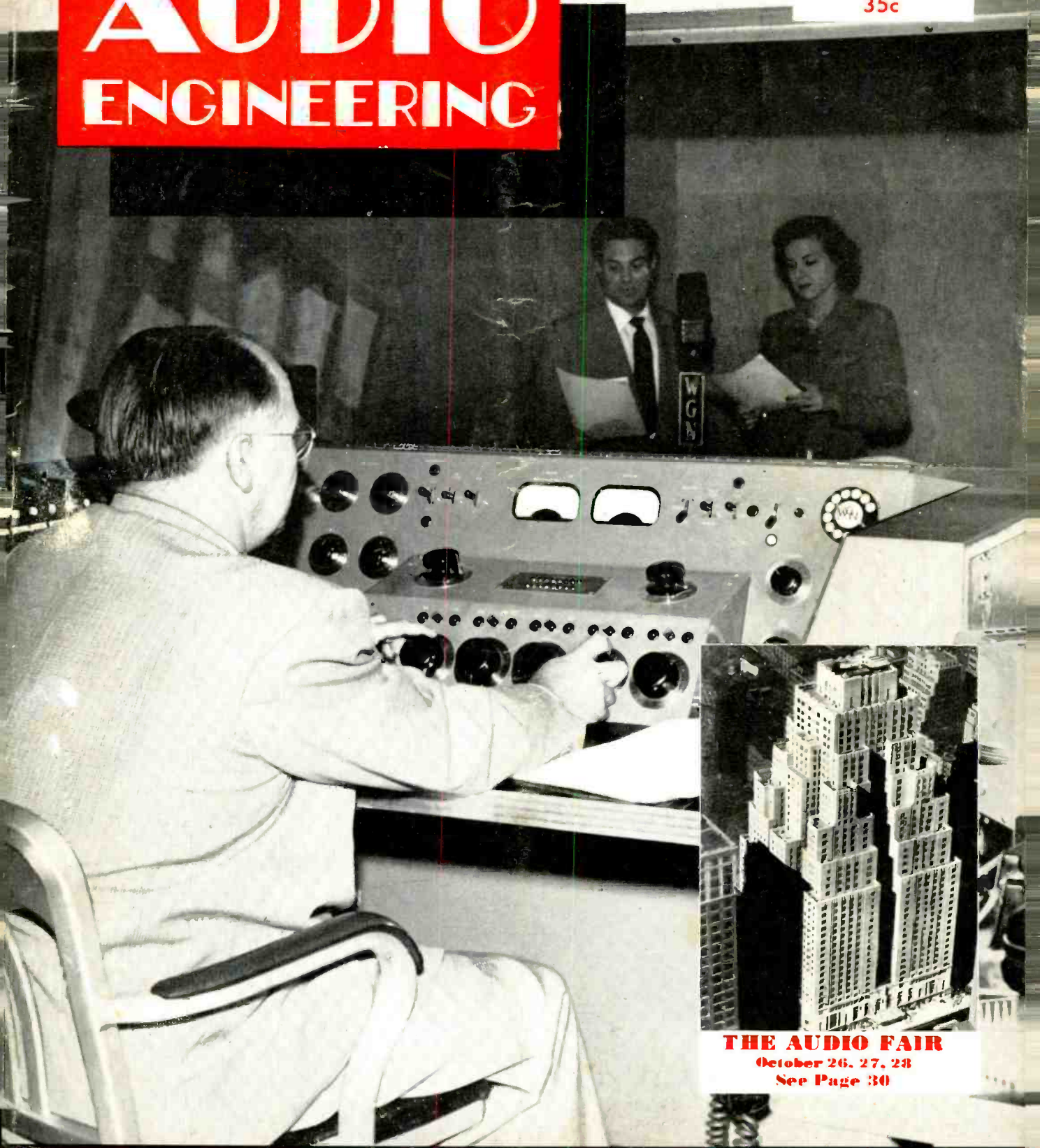

THE AUDIO FAIR
October 26, 27, 28
See Page 30

Published by RADIO MAGAZINES, INC.

www.americanradiohistory.com



Look at the new audiotape*

Yes, you can actually see the difference. The way it tracks and winds absolutely flat, due to superior, straight-line slitting. Its smooth, non-curling flexibility—and the way it rides snugly over the heads without humping away in the middle. And,

compared under a microscope, you can see Audiotape's superior dispersion of the oxide particles—free from "clumping" which tends to increase background noise. You can tell a lot just by looking at Audiotape, but...



Listen to its matchless reproduction

That's the real test. Audiotape actually does "speak for itself." Hear its brilliant high-frequency response—freedom from annoying background noise and distortion. There's no friction squeal—no rasping hum

from low-frequency modulation noise. And a sensitive ear can appreciate the remarkable uniformity of output volume, varying not more than $\pm 1/4$ db for an entire 2500 foot reel.

Original recordings for phonograph records of America's leading artists are made on Audiotape. There must be a reason!

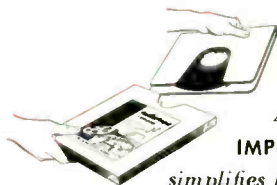

And see how Audio's
IMPROVED PACKAGING
simplifies handling and storage

All 2500 and 5000 foot rolls of Audiotape are individually boxed in specially designed containers (Pat. Pending) that make handling and storage safer and easier than ever before. Tape can be transferred from container to turntable (and vice versa) without danger of slipping from the hub or becoming unwound. Reel side flanges can be attached to hub without removing it from container. In storage, tape hangs from hub core—does not rest on edge of roll.

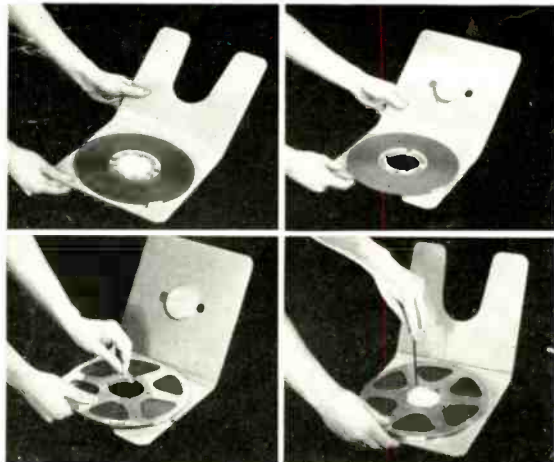

SEND FOR FREE
300 FOOT SAMPLE
of plastic or paper base
Audiotape today

AUDIO DEVICES, INC.

444 MADISON AVE., NEW YORK 22, N. Y.
Export Dept.: ROCKE INTERNATIONAL, 13 East 40th St., New York 16, N. Y.



Makers of
audiodescs*

... the standard of disc recording
quality for more than a decade

*Trade Mark

AUDIO ENGINEERING

Successor to **RADIO**

Established 1917



C. G. McProud, Editor

Luci Turner, Production Manager

E. E. Newman, Circulation Manager

D. S. Potts, Publisher

S. L. Cahn, Advertising Director

H. N. Reizes, Advertising Manager

Editorial Advisory Board

Howard A. Chinn

John D. Colvin

C. J. LeBel

J. P. Maxfield

George M. Nixon

Representatives

Sanford R. Cowan, Mid-West Sales
342 Madison Ave., New York 17, N. Y.
James C. Galloway, Pacific Coast Sales
816 W. 5th St., Los Angeles 17, Calif.
Technical Book & Magazine Co.
297 Swanston St., Melbourne, C. I.
Victoria, Australia

CONTENTS OCTOBER, 1950 Vol. 34, No. 10

Letters	2
Technicana	6
Book Reviews	8
Editor's Report	10
Audio Patents	12
Sensitivity, Directivity, and Linearity of Direct Radiator Loudspeakers— <i>Harry F. Olson</i>	15
Remote Installations— <i>Elliot D. Full</i>	18
Optimum Use of Nickel Alloy Steels in Low-Level Transformers— <i>L. W.</i> <i>Howard</i>	20
A New Loudspeaker of Advanced Design— <i>Daniel J. Plach</i> and <i>Philip B.</i> <i>Williams</i>	22
"Williamson" Type Amplifier Using 6A5's— <i>J. H. Beaumont</i>	24
AUDIO engineering society SECTION	
Automatic Audio Gain Controls—2— <i>J. L. Hathaway</i>	27
AES Convention Program	30
Audio Fair Directory	32
Audio Design Notes—Chart Showing Wavelength for Air	34
Audiana—Dynamical Analogies—2— <i>Lewis S. Goodfriend</i>	36
Record Revue— <i>Edward Tatnall Canby</i>	38
Pops— <i>Rudo S. Globus</i>	38
A Controversial Idea from England— <i>P. G. A. H. Voigt</i>	40
New Literature	66
New Products	67
Advertising Index	72

COVER

Studio control console of WGN's studio 2A in the new multimillion dollar WGN Building in Chicago.

AUDIO ENGINEERING (title registered U. S. Pat. Off.) is published monthly at 10 McGovern Ave., Lancaster, Pa., by Radio Magazines, Inc., D. S. Potts, President; Henry A. Schober, Vice-President. Executive and Editorial Offices: 342 Madison Avenue, New York 17, N. Y. Subscription rates—United States, U. S. Possessions and Canada, \$3.00 for 1 year, \$5.00 for 2 years; elsewhere \$4.00 per year. Single copies 35c. Printed in U. S. A. All rights reserved. Entire contents copyright 1950 by Radio Magazines, Inc. Entered as Second Class Matter February 9, 1950 at the Post Office, Lancaster, Pa. under the Act of March 3, 1879.

still the best...



604B Duplex

Enthusiastically acclaimed by engineer and music lover alike, the ALTEC 604B Duplex is still the finest loudspeaker of its type ever produced.

Its smooth frequency response, fine musical qualities and exceptional efficiency make it the choice for professional monitoring, auditioning, and for those whose critical tastes demand the best for home music installations. On one frame, the 604B Duplex incorporates independent high and low frequency reproducing units, designed to function without distortion-producing interaction. Built-in multicellular horn properly loads high frequency unit and permits optimum dispersion of "highs." Frequency response of 30 to 16,000 cps more than spans the FM range.

**ASK FOR A DEMONSTRATION
DEALERS EVERYWHERE**



1161 N. VINE STREET, HOLLYWOOD 38, CALIF.
161 SIXTH AVENUE, NEW YORK 13, NEW YORK

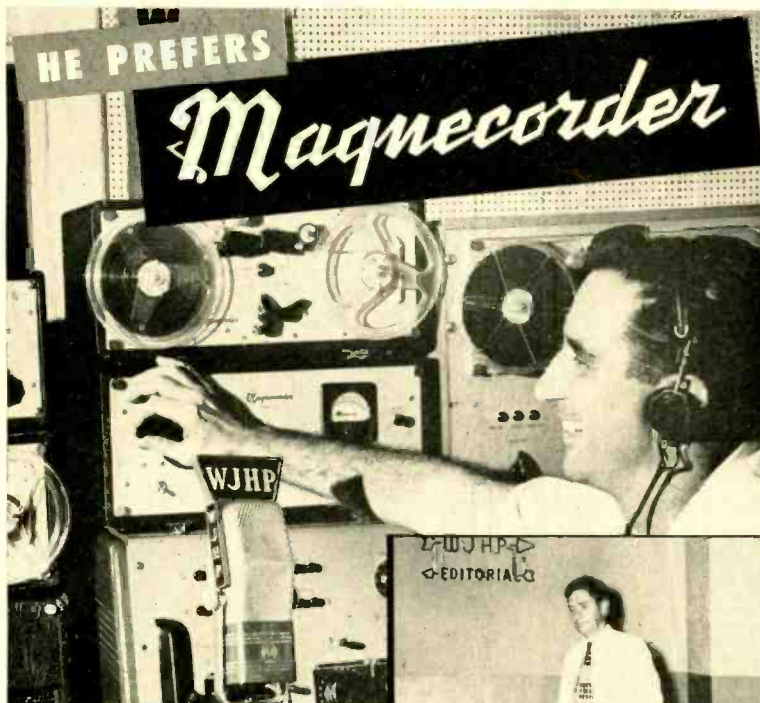

USED BY MORE RADIO STATIONS THAN ALL OTHER TAPE RECORDERS COMBINED

GREATEST FLEXIBILITY

In the studios or out, a Magnecorder meets every need. Mount a Magnecorder in a rack or console cabinet for delayed studio or network broadcasts. For remotes, a Magnecorder is ready to go in its really portable cases.

Add to your Magnecord equipment as you need it—combine and carry Magnecorders to suit every purpose.

HIGH FIDELITY, LOW COST

Users are enthusiastic about the lifelike tone quality and low distortion of Magnecordings. Magnecord frequency response: 50-15 kc \pm 2 db. Harmonic distortion less than 2%. Signal-noise ratio: 50 db. Meets N.A.B. standards. No other recorder offers such high fidelity at such a low price.

MORE FEATURES

Your Magnecorder, new or old, can now have 3 heads (separate erase, record, and playback) to permit monitoring from tape. Three speeds (15", 7 1/2", 3-3/4")—up to an hour on a 7" reel—available on both PT6 and PT63 equipment. Dual track heads also available if desired.

Write for NEW CATALOG

MAGNECORP, Inc., Dept. A 10
360 N. Michigan Ave., Chicago 1, Ill.
Send me latest catalog of Magnecord equipment

Name.....

Company.....

Address.....

City..... Zone..... State.....



A Magnecorder is really portable!

MAGNECORDER

For every purpose . . . every purse!



PT6 SERIES
Most widely used professional tape recorder in the world.



PT63 SERIES
Three heads to erase, record, and monitor from the tape.



PT7 SERIES
A complete console for only \$950.00. Outstanding features and flexibility. Models for portable or rack mount also available.

LETTERS

Hearing Aid AGC

Sir:

In your June 1950 issue there appeared an instructive article by H. Hardwick on "Hearing Aid Trends." Mr. Hardwick discusses at length the types and characteristics of deafness and of hearing aids which are illustrated by Figs. 1 to 11. Finally, on Fig. 12, without any comments in the text, he gives a desirable input-output characteristic showing a 40-db volume compression over an input range of 120 db.

This is most important for the following two reasons:

- (1) With all or most deaf persons, the threshold of pain remains unchanged by the hearing loss so that amplification of loud sounds hurts them.
- (2) In certain types of nerve deafness the hearing loss is not logarithmically but arithmetically constant so that faint signals are greatly attenuated, strong ones hardly at all. Sufferers from this type of deafness need considerable volume compression in their hearing aids to avoid painful annoyance.

Compression can be applied to the instantaneous sound pressure or to the signal envelope. The latter method, although preferable, requires a combination of rectifying elements with low-pass filters of suitable time constants for attack and release.

As one who has preached volume compression in hearing aids to "deaf ears" for more than ten years, I should like to see more emphasis placed on this point. For hundreds of thousands of people it will mean all the difference between satisfactory use and rejection of hearing aids.

W. J. Albersheim, Eng. D.
Research Staff,
Bell Telephone Laboratories,
Deal, N. J.

Choral Recording

Sir:

Listening to the recent Haydn Society recordings of choral works has prompted me to what I hope is constructive criticism in regard to the manner in which choral works are recorded in this country and in England, in contrast to those from continental Europe. I refer to the lack of balance between the orchestra and the chorus, with the chorus always being favored—either by the symphony conductor or by the recording engineer, or perhaps by both.

Why should the orchestra be almost completely blotted out by the overwhelming power of the voices in loud passages when the orchestra is just as important as the chorus? What is the use of an orchestra if one does not hear it, or if one hears it only sporadically when the voices are silent or sing at low level? The prominence of the orchestra should at least match the voices, and in contrapuntal works should be further emphasized because it is an integral part of the structure and just as important as the voices. Conductors and/or recording engineers should keep this in mind when making recordings of this type. It is a complete delight to listen to the Haydn Society recordings of Haydn's Missa Solemnis and Mozart's Mass in C Minor because the orchestra is right in front where it should be, and the listener does not need to strain his ear trying to follow the orchestra behind a tremendous volume of voices.

David Fonseca,
555 Notre Dame Ave.,
Chattanooga 4, Tenn.

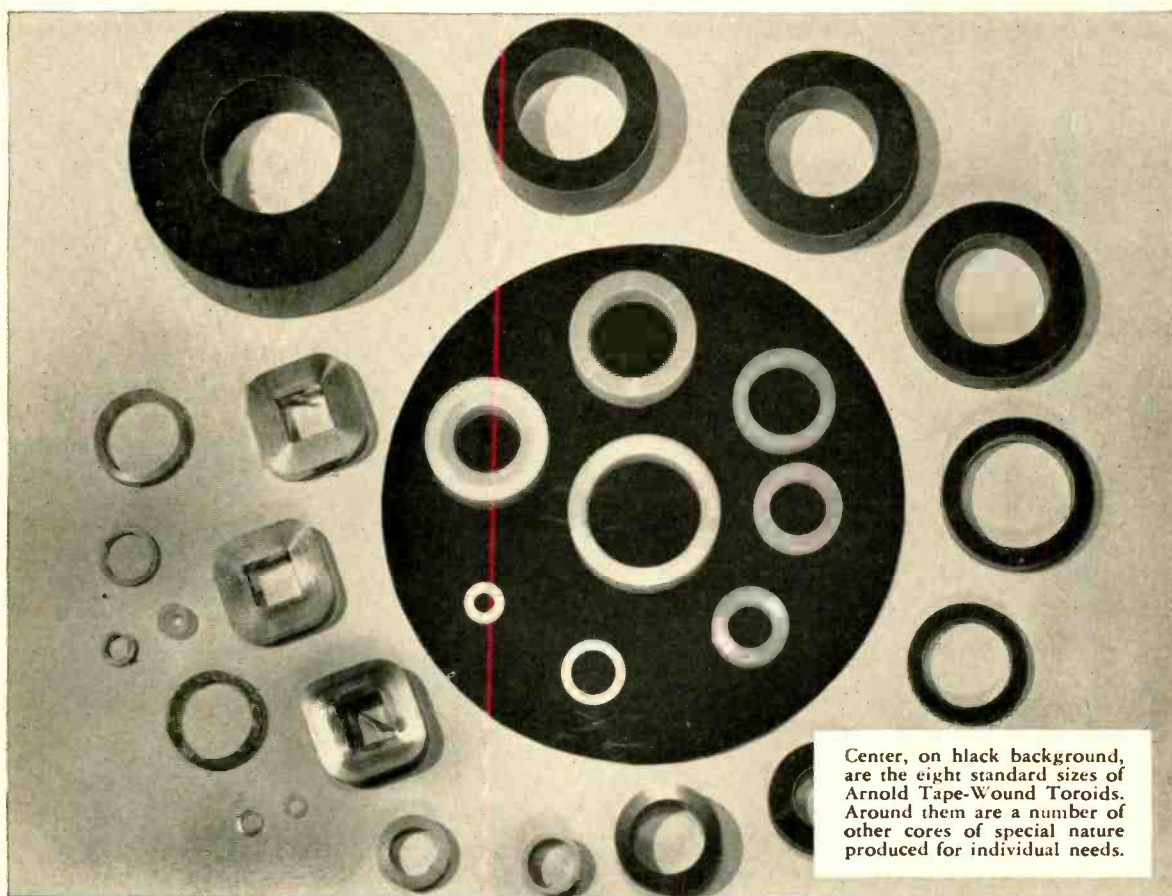

Center, on black background, are the eight standard sizes of Arnold Tape-Wound Toroids. Around them are a number of other cores of special nature produced for individual needs.

ARNOLD TAPE-WOUND TOROIDAL CORES

of DELTAMAX

4-79 MO-PERMALLOY
SUPERMALLOY*

In addition to the standard toroids described at left, Arnold Tape-Wound Cores are available in special sizes manufactured to meet your requirements—toroidal, rectangular or square. Toroidal cores are supplied in protective cases.

* Manufactured under licensing arrangements with Western Electric Company.

WAB 3102

APPLICATIONS

MAGNETIC AMPLIFIERS
PULSE TRANSFORMERS
NON-LINEAR RETARD COILS
and TRANSFORMERS
PEAKING STRIPS, and many other
specialized applications.

RANGE OF SIZES

Arnold Tape-Wound Toroids are available in eight sizes of standard cores—all furnished encased in molded nylon containers, and ranging in size from 1/2" to 2 1/2" I.D., 3/4" to 3" O.D., and 1/8" to 1/2" high.

RANGE OF TYPES

These standard core sizes are available in each of the three magnetic materials named, made from either .004", .002" or .001" tape, as required.

THE ARNOLD ENGINEERING COMPANY



SUBSIDIARY OF ALLEGHENY LUDLUM STEEL CORPORATION

General Office & Plant: Marengo, Illinois

SOUND TRANSLATION.

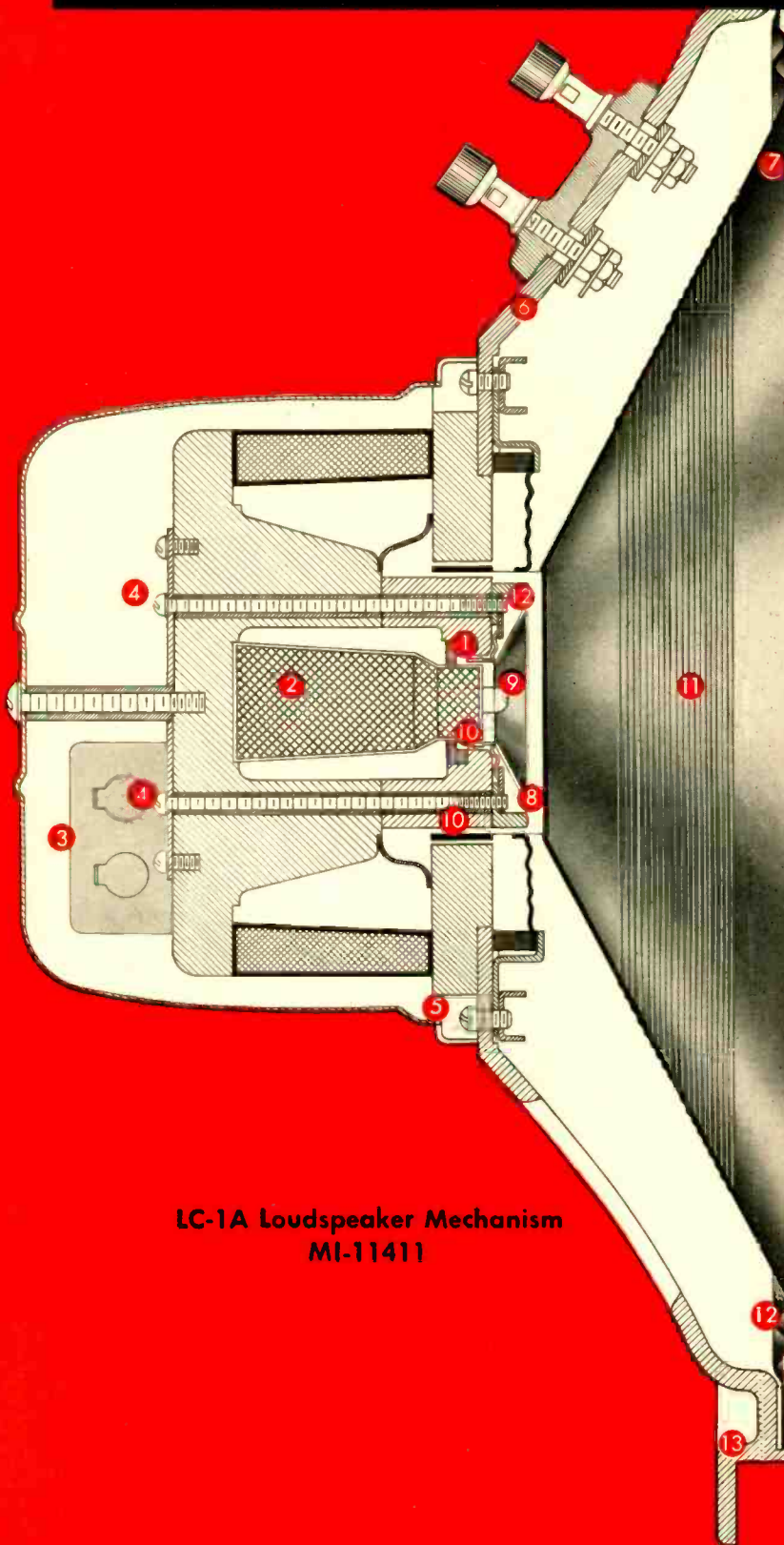

LC-1A Loudspeaker Mechanism
MI-11411

1 H-f voice coil, aluminum wire-wound, to deliver full h-f range

2 Heavy ALNICO V magnets

3 Cross-over condenser

4 Centering adjustment for h-f cone

5 Centering adjustment for l-f cone

6 Sturdy die-cast aluminum frame

7 Shallow cone for smooth response and greater angle of distribution

8 H-f and l-f cones coaxially-mounted, mechanically independent

9 H-f cone. Diaphragm diameter only 2 $\frac{3}{8}$ ". Wide-angle distribution to 15,000 cycles

10 Ample gap clearances

11 Massive 15" l-f cone. Bass response 35 to 2000 cycles at all volume levels

12 Cone rim treated to minimize edge reflections for smoother response

13 Offset mount eliminates front cavity — insures smooth response

.....next to perfect!

The Famous LC-1A Speaker

Among the great achievements of the RCA Princeton Laboratories is the development of the most advanced speaker in the world—the RCA Duo-Cone, Type LC-1A.

Expressly designed to give sound its true translation, this professional speaker is matched by no other high-quality sound reproducer.

Unique duo-cone design (originated by Dr. H. F. Olson of RCA Princeton Labs) provides a smooth response from 50 to 15,000 cycles—with no resonant peaks, harmonics, or transient distortion. Full power is radiated over 120-degrees at 15,000 cycles—makes it possible to enjoy high-fidelity sound *any place in the room!* Smooth crossover response around 2000 cycles eliminates all undesirable interference between the high-frequency unit and the low-frequency unit. Controllable "roll-off" at 5 and 10 kc... when used with the MI-11707 filter... restricts the h-f distortion and surface noises present in many recordings.

Today, more than 3000 of these speakers are serving in station control rooms, listening rooms, auditioning booths, lobbies, clients' offices, and private homes.

For more information, mail the coupon.

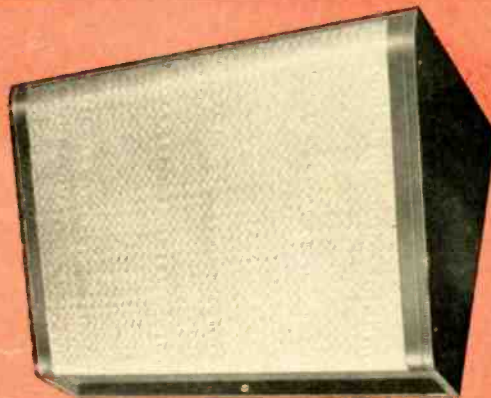

New Wall-Ceiling Housing for LC-1A

Ideal for sound reinforcement in control rooms, auditioning booths, hallways, talkback positions, elevators,

executive offices. Port provided for increasing bass response. Finished in harmonizing 2-tone umber gray.

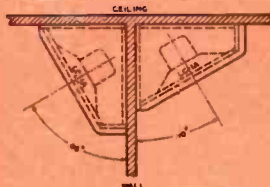

It's Easy to mount

The Wall-Ceiling Housing can be mounted for long or short "throws"—makes the wall and ceiling a part of the acoustical system.

The LC-1A Monitoring Speaker, with Console cabinet and MI-11707 filter

The finest reproducer in the business. Available in a choice of 2-tone umber gray or walnut finish.



AUDIO BROADCAST EQUIPMENT
RADIO CORPORATION of AMERICA
ENGINEERING PRODUCTS DEPARTMENT, CAMDEN, N.J.

In Canada: RCA VICTOR Company Limited, Montreal

Department 7J,
RCA Engineering Products
Camden, N. J.

Send me price and information on

- LC-1A Speaker Mechanism, MI-11411
- LC-5A Wall-Ceiling Cabinet, MI-11406
- LC-1A Speaker with Console Cabinet, MI-11411/11401

Name _____

Station or firm _____

Address _____

City _____ State _____

TECHNICANA

Vehicle Noise

The continuing study of vehicle noise by the Armour Research Foundation in cooperation with other groups is the subject of a survey, "Levels and Spec-

tra of Transportation Vehicle Noise," by G. L. Bonvallet, appearing in the March 1950 *Journal of the Acoustical Society of America*. This study covers transportation noises of all types

throughout both residential and industrial areas, and was started before the war.

Measurement of noise and spectra levels was carried out both inside and outside of various transportation vehicles operating at their normal speeds, both during the summer and during the winter.

A series of tables and charts evaluates much of the data, and a suggestion that the objectionable quality of the noises and their loudness is more easily correlatable with the level of the 400-800 cps band than with other figures used previously, but much of the data is presented in the form of octave-band curves which the group making the study believes to be of more value than the single noise level figures based on overall level or the 400-800 cps band level. It may be seen from the curves that old subway and elevated cars have a noise level 15 to 20 db higher than new ones in the 400-800 cps band, both inside and out.

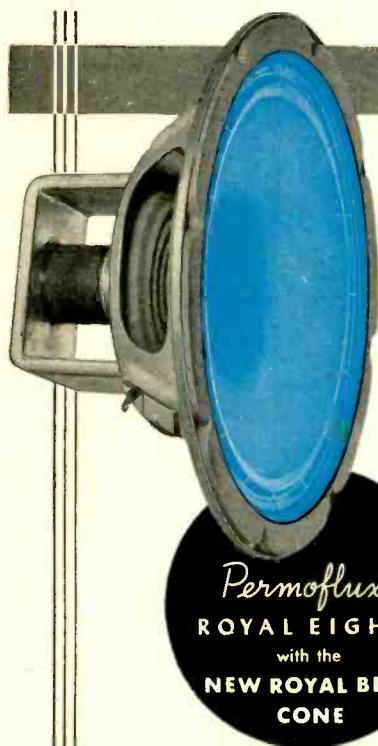

new

Permoflux
ROYAL EIGHT"
compares with
any 12" speaker!

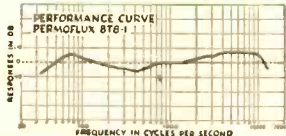

This averaged laboratory response curve of the Permoflux 8T8-1 proves that it compares with the finest speakers regardless of size or price.

It's Your "Springboard" to Extra Sales with Customers who want 12" performance but don't want to pay a 40% higher price.

From the resonant boom of jungle drums to the light warble of the flute, this new 8" speaker reproduces sound with superior sensitivity and fidelity. The tonal qualities of this magnificent speaker can only add to the excellence of any audio equipment.

Special processing provides extra-strong cone; allows cone to be soft-suspended from basket and held at coil-end by extra-large spider. Permits more faithful reproduction at lower frequencies. Deeper, curvilinear cone greatly extends high-frequency response.

Permoflux Royal Eight" (Model 8T8-1) is ruggedly-built, and simple to install. Provides big speaker performance in a small frame—uses smaller, more economical baffle. List Price \$15.00.

Send for Catalog No. J201—Dept. AE

TRADE MARK
PERMOFLUX
 "SOUND IN DESIGN"
PERMOFLUX CORPORATION
 4900 W. GRAND AVE., CHICAGO 39, ILL. • 236 S. VERDUGO RD., GLENDALE 5, CALIF.

"Williamson" Amplifier Popularity

The popularity of the Williamson amplifier is attested to by the amount of space that it has been given in foreign publications. The latest to carry a full article is the Danish magazine *Radio Echo*. In a recent issue it carried an article covering circuits and construction information. A detailed discussion of the characteristics and construction practice of the transformer for the Williamson amplifier appeared in the March 1950 issue.

Home-Built Magnetic Recorder

In a complete issue devoted to audio frequency articles, the French publication *Toute la Radio* for June 1950 covers many phases of audio including articles on sound and noise, loudspeaker baffles, amplifier design, a standard frequency oscillator, and a magnetic recorder.

Of most interest to readers of *Æ* is the last mentioned article on an easily constructed wire recorder. Only the mechanical unit is described in this article, but the design and construction information is given, and the unit appears to be well adapted for construction in this country. It uses two motors, and a Shure W12 combination wire recording head. Among the features are a counter, mechanical braking, and the use of standard wire available in the United States.

Photography

"Photographing Sound Waves" is the title of an article appearing in the July 1950 *Bell Laboratories Record*. In order to obtain photographs of the sound field obtained with acoustic lenses and prisms, W. E. Kock and F. K. Harvey have

[Continued on page 57]

LOW DISTORTION SIGNAL SOURCE FOR BROADCAST MEASUREMENTS

-hp- 201B AUDIO OSCILLATOR



**EASY TO USE
INEXPENSIVE
HIGH OUTPUT
LOW DISTORTION**

SPECIFICATIONS

Frequency Range: 20 cps to 20,000 cps, 3 bands

- X 1—20 to 200 cps
- X 10—200 to 2,000 cps
- X 100—2,000 to 20,000 cps

Frequency Calibration: Direct in cps for lowest band. Approximately 95 calibration points provided over 300° arc. 6" diameter illuminated dial, driven by vernier knob with 6:1 ratio. 47 inch effective scale length for 3 bands.

Stability: Better than $\pm 2\%$ under normal conditions (includes initial warm-up drift). No change in output frequency caused by line voltage variations as high as ± 10 volts. Each band has adjustments to standardize calibration against a known frequency. With standardization, accuracy better than $\pm 1\%$.

Output: Rated maximum 3 watts or 42.5 volts into a 600 ohm resistive load. One terminal is at ground potential. Maximum no-load voltage is at least 50 volts.

Frequency Response: Constant within ± 1 db over entire frequency range.

Distortion: Less than 1% at 3 watts output. Less than 0.5% distortion at 1 watt output (down to 50 cps). Approximately 1% distortion at 20 cps.

Hum Level: Less than 0.1% of maximum amplifier output voltage.

Volume Controls: Amplitude control adjusts amount of oscillator voltage fed to output amplifier. Attenuator attenuates amplifier output. Approximately linear between 0 to 40 db.

Power Supply: 115 volts ± 10 volts, 50/60 cps, 75 watts.

Mounting: Rack or cabinet wrinkle-grey finish. Rack mounting \$5.00 extra. Size 17" long, 8½" high, 11" deep.

Price: \$250.00 f.o.b. factory.

Data subject to change without notice.

Broadcast stations across the country find this high-fidelity *-hp-* 201B Audio Oscillator an ideal signal source for broadcast measurements, including new station performance data now required by the F. C. C. It meets every FM or AM requirement for speed, ease of operation, accuracy and purity of wave form. It enables you to quickly, easily and accurately make such measurements as high fidelity amplifier tests, overall station frequency response, overall station distortion, studio-transmitter line characteristics, etc.

3 WATTS OUTPUT

The *-hp-* 201B provides 3 watts of output power into a 600 ohm resistive load, sufficient to drive almost any kind of broadcast, laboratory or production equipment. Distortion may be limited to less than 0.5% at power of 1 watt or less. Hum level and output level can be attenuated together, and hum level is held 70 db under signal level for accuracy in working with small test signals.

20 TO 20,000 CPS

The instrument has a frequency range of 20 to 20,000 cps, covered in 3 bands. Frequencies can be tuned directly or by a 6:1 vernier control.

Effective scale length is about 47" and the no-parallax tuning dial has 95 calibration points occupying 300 degrees of the scale. The entire instrument is rigidly constructed for long service; sturdy, light weight and easy to handle. It is completely powered from any 115 volt ac power source.

Get complete details. See your nearest *-hp-* representative or write direct.

HEWLETT-PACKARD CO.

1556A Page Mill Road • Palo Alto, Calif.

Export: FRAZAR & HANSEN, LTD.
301 Clay Street, San Francisco, California, U. S. A.
New York, N. Y., Los Angeles, Calif.

1078

hp laboratory instruments
FOR SPEED AND ACCURACY

AMPERITE

STUDIO MICROPHONES at P.A. PRICES!



at CLOSE TALKING



and DISTANT PICK-UP

YOU CAN SHOUT RIGHT INTO IT, or STAND AWAY
... In either case, Quality will be perfectly natural. Output change reduced to a minimum by the Automatic Volume Control effect achieved by special construction.

**AMPERITE
Ribbon Mike
LEADS 7 WAYS**

- 1 **BLASTPROOF:** No "boom." or stand 12" away, response is always perfect.
- 2 **LOWEST FEEDBACK:** much less than any diaphragm type mike with equal frequency response.
- 3 **LESS DISTORTION;** below 1%.
- 4 **FLAT RESPONSE** without peaks over frequency range of 50-11,000 cps.
- 5 **OUTPUT** (-62 db); automatic volume control effect achieved with special construction.
- 6 **COMPACT** and RUGGED.
- 7 **UNAFFECTED** by CHANGES in climatic conditions, wind, etc.



Models:
RELG—200 ohms
RBHG—hi-imp.
List \$42.00



Amperite "Kontak" Mikes

Model SKH, hi-imp List \$12.00
Model KKH, with hand volume control List \$18.00

**AMPERITE CARDIOID
DYNAMIC MICROPHONE**

Models FCH-PGL List \$32.00



SPECIAL OFFER:
Write for Introductory Offer, and
4-page Microphone Folder 33-MK

AMPERITE Company, Inc.

561 Broadway • New York 12, N. Y.

In Canada: Atlas Radio Corp., Ltd., 560 King St., W., Toronto 26

Book Reviews

Records, 1950 Edition, by David Hall. 556 pp. New York: Alfred A. Knopf, Inc., \$5.00.

A critical listing of all domestic recordings of serious music issued since December 31, 1947, regardless of speed, together with a large listing of foreign records selected for technical and musical quality. No such book can possibly be completely up to date, but for those who have begun to assemble a record collection since the LP entered the field, this volume is indispensable. The beginner in the high-quality audio field is treated to a thorough dissertation on records and recording methods in terms which are readily understood by the layman, and written in such a manner as to give the reader a background in the entire subject so that he may know what to look for in equipment as well as in records. This section is followed by a panorama of records and recording companies over the past three years.

The records are listed alphabetically by composer, and include the various performances of each work. Following the listing, a general criticism of the selections enables the careful reader to choose the specific recording which should best satisfy his tastes. The index of performing artists is helpful in locating the works recorded by each, and while it represents a fantastic amount of work by the author in its preparation, it is well worth it in the time saved when the records of a specific artist or organization are desired.

Mr. Hall's book is definitely recommended as a volume which should be in regular use by every collector of serious recorded music.

The Radio Manual, by George E. Sterling and Robert B. Monroe. 890 pp. New York: D. Van Nostrand Company, Inc. \$12.00.

This completely revised fourth edition of the old standby has been needed for some time. Since the third edition was published in 1938, the advances in radio communication have been so rapid that the book was obsolescent.

The Radio Manual is an excellent textbook for those who would start with fundamentals and cover the entire field; it commences with elementary electricity and magnetism, and covers motors and generators, batteries, electron tubes, and the many applications of radio in all fields of communication.

The chapters on amplitude and frequency modulation systems cover theory and give a great number of circuits for practical apparatus for transmitting and receiving and for many items of test equipment used in transmitter testing and maintenance. This material is of general educational value, and may be useful as a guide to the circuitry employed in this type of equipment. Audio engineers will find considerable useful information in the chapter on broadcast studio and control room equipment.

In this latest edition, the vast experience of Commissioner Sterling in commercial radio has been augmented by the more recent broadcast experience of CBS's Robert Monroe. The book has been brought up to date by the inclusion of chapters on marine navigational aids—such as radar and loran—and lists the complete rules and regulations of both the F.C.C. and the International Telecommunications Conference of Atlantic City 1947.

A New, MODERATELY Priced A-C VACUUM TUBE VOLTMETER

- **FIVE RANGES:** four scales cover the 5 ranges from 0.1 to 150 volts, a-c (full scale 1.5, 5, 15, 150, and 150 volts)
- **ACCURATE:** $\pm 3\%$ of full-scale on all ranges; r-m-s values of sine-wave voltage
- **FREQUENCY RANGE:** without correction, up to 120 Mc with maximum error of 10%; correction curve supplied
- **INPUT IMPEDANCE:** equivalent input capacitance of probe is 11.5 μf ; with plug connectors 12 μf ; equivalent parallel input resistance 7.7 megohms at low frequencies
- **SINGLE ZERO ADJUSTMENT:** for all ranges
- **INTERNAL CALIBRATION CONTROL:** single adjustable resistor corrects calibration if amplifier tube is changed
- **AUXILIARY CONNECTORS:** G-R double plug, pair of 30-inch test leads, pair of test prods and two alligator clips supplied as convenient accessories
- **SMALL — LIGHT WEIGHT:** only 9¼ pounds

TYPE 1803-A A-C VACUUM-TUBE VOLTMETER \$145

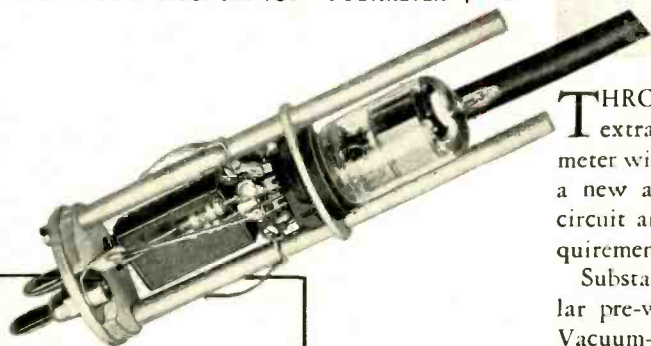

Probe with completely shielded case removed. Twin diode tube in the probe has an inactive section connected to the grid of one triode in the V-2 amplifier while the active section is connected to the grid of the other triode, both sections of the amplifier being used in a balanced circuit. The balanced amplifier insures very little zero shift when the line voltage varies.

THROUGH the elimination of many unnecessary frills and extra circuit refinements which would be necessary in a meter with ohmeter and d-c circuits and scales, G-R announces a new a-c vacuum-tube voltmeter with a straightforward circuit and with accuracies sufficient for most laboratory requirements, at a very moderate price.

Substantially duplicating the performance of the very popular pre-war Type 726-A instrument, the new Type 1803-A Vacuum-Tube Voltmeter sells for less than its predecessor and is improved over the older model in that it is smaller, lighter, has a probe which is smaller and completely shielded, a single zero adjustment for all ranges and a power supply not limited to operation at a single frequency.

The probe plugs into clips on the side of the cabinet, in which position the auxiliary test leads and terminals supplied with the instrument can be attached conveniently to the input connections.

This instrument should find wide application in many laboratories operating on a modest budget. Its accuracy is sufficient for the majority of laboratory measurements.

WRITE FOR COMPLETE DATA



GENERAL RADIO COMPANY

Cambridge 39,
Massachusetts

90 West St., New York 6 920 S. Michigan Ave., Chicago 5 1000 N. Seward St., Los Angeles 38

EDITOR'S REPORT

THE AUDIO FAIR

FOR THE SECOND TIME, the halls of Hotel New Yorker will be filled with a milling throng for three days this month—with rooms on both the fifth and sixth floors being given over to the displays of the manufacturers and jobbers of everything in the audio field. Ranging from complete speech input systems for broadcast and recording studios to the smallest transformers used in audio, and with tape and disc recorders, high-quality radio tuners, speaker cabinets, amplifiers, pickups, attenuators, and many other devices and components, The Audio Fair 1950 is certain to be more entertaining and interesting than was the first one.

Not to be overlooked are the five technical sessions of the second annual convention of the Audio Engineering Society, with over twenty papers covering all branches of audio. As before, a small charge will be made to non-members for attendance at these sessions, but by applying for membership in the Society at the time of registration, this charge may be avoided.

The growth of the Society over the past two years is strong indication of greatly increasing interest in audio. Starting with a group of twenty members in 1948, the Society now numbers over 1000 in its membership, with sections in most principal cities of the country.

SCARE BUYING

The current world situation has already been reflected in shortages of many items of electronic equipment in a fashion which is somewhat reminiscent of the early 40's, and which is either a monument to business acumen and enterprise or a sad commentary on human nature.

Granted that production of electronic equipment is greatly accelerated because of military requirements, and granted further that each manufacturer must make sure that his supply lines are functioning properly, there is no excuse for unwarranted hoarding of components. The maintenance of reasonable inventories of component parts is desirable from any viewpoint, but if deliveries are being made in a specified length of time and have some promise of continuing at the same rate, intelligent buying warrants inventories only adequate to take care of the delivery period.

Resistor deliveries from manufacturers have recently been quoted at thirty-five weeks, but this delay has been of so long a standing that it is presumed that most of this particular shortage may be attributed to television. Certain of the 12-volt series of tubes—12AT6, 12AU7, and 12AX7 in particular—have been unobtainable for several weeks, and 5U4G's are scarce.

We are firmly in favor of keeping a reasonable number of spare tubes on hand—even for home or small public address installations. The FCC Standards of Good Engineering Practice call for the stocking of a spare tube of every type employed in transmitters and in frequency and modulation monitors, with the proviso that when one or two tubes of a given type are employed, it is necessary to carry only one spare; for 3 to 5 tubes of a type, 2 spares are necessary; for 6 to 8 tubes of a type, 3 spares; and for over 9 tubes of a type, 4 spares shall be kept on hand. This is a good policy for any user of tubes, and need not be expanded to require the stocking of a spare tube for every socket as is the practice in some quarters.

As far as tubes are concerned, this number of spares should not necessarily tighten up the supply appreciably, but would give everyone an opportunity to be adequately protected in case of failures—such as have been experienced by practically everyone late on a Saturday night. As to other components, circumstances may alter the size of the inventory which seems desirable, but it is hoped that users may overhaul their methods so that complete draining of supply lines will not be effected.

THE CATHAMPLIFIER

From Australia we have recently received a booklet describing the Parry Cathamplifier—a new type of push-pull audio-frequency amplifier system. This unit is claimed to give high-quality performance with a minimum of components, and from the circuits shown it is apparent that relatively few components are employed.

Basically, this circuit consists of a single voltage amplifier pentode followed by push-pull output pentodes or tetrodes, the phase inversion being provided by a self balancing arrangement comprising a transformer with its primary connected to the two cathodes of the output tubes and the secondary exciting the grid of the phase-inverting stage. Circuits are shown for amplifiers of 8, 15, and 40 watt outputs. After a reasonable amount of investigation has been made of the potentialities of this unit, it will be further described in these pages.

TECHNICANA RETURNS

The long absent section covering interesting developments in the audio field as described in foreign and some specialized U.S. publications will be welcomed by many who have suggested that it be resumed. While the space devoted to such material may be too limited for complete descriptions of the subjects, it will at least serve to direct the attention of the reader to the originating publication for further information. This column will be scheduled for alternate months.



**LOUDSPEAKER
MODEL 180L**

Designed to satisfy the musical ear. A low-cost high quality loudspeaker with smooth wide-range response (within 5 db, 45 to 12000 cycles) and low distortion . . . the only loudspeaker with acoustically adjustable bass response . . . occupies less floor space than any other high quality loudspeaker — less than one square foot.



**PREAMPLIFIER
MODEL 130H**

This preamplifier represents the most advanced design ever achieved in phonograph preamplifiers . . . it equalizes the bass response of records and transcriptions and provides the necessary gain for high quality magnetic pickups . . . its intermodulation and harmonic distortion is exceptionally low — better than most professional equipment.

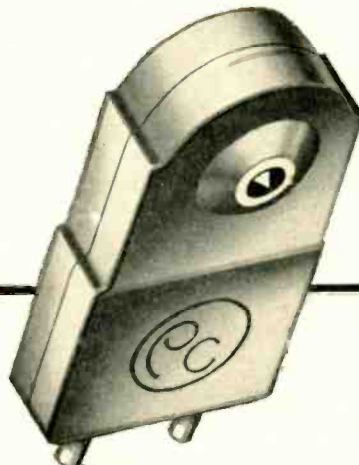

**PICKERING PICKUP CARTRIDGES
FOR THE FINEST AUDIO QUALITY**

No other Pickup will reproduce LP records with the fidelity of Pickering Cartridges . . . they are the most widely used by record manufacturers, recording studios, broadcasters and music enthusiasts who demand the effect of a live performance from their records.

The nearest approach to a live performance is a recording played by a system equipped with Pickering High Fidelity Audio Components . . . Speaker, Cartridge, Arm, Preamplifier, Record Compensator, etc.

Pickering Cartridges Series 120 and 150 are for standard records . . . Series 140 are for microgroove records . . . They track with phenomenally low record wear and virtually eliminate harmonic and intermodulation distortion as well as frequency discrimination . . . all Pickering Cartridges available with either sapphire or diamond stylus.



**RECORD
COMPENSATOR
MODEL 132E**

This compensator, with 6 positions of equalization, provides the flexibility required to properly equalize for the different recording characteristics used by various record manufacturers . . . it is a most important addition to record playing systems using magnetic pickups.



PICKUP ARM — MODEL 190

The only arm specifically designed for optimum performance on both microgroove and standard records.

- Statically balanced to eliminate tendency to skip when jarred.
- Minimum vertical mass to track any record without imposing extra vertical load on grooves.
- Sensitive tracking force adjustment.
- Magnetic arm rest.
- Rugged frictionless bearings.
- Plug-in cartridge halder.
- One-hole mounting — self-contained levelling screws.

Cartridges used with this arm require 50% less vertical tracking force than when used in conventional arms.

**Pickering
& Company, Inc.**

For the finest audio quality specify Pickering Components

Oceanside, N. Y.

Pickering High Fidelity Components are available through leading jobbers and distributors everywhere . . . detailed literature will be sent upon request.

**PFANSTIEHL
PICKUP
IS TO
OTHER PICKUPS**

as **FM RADIO
IS TO
AM RADIO**

The difference between the quality of music obtainable from the new PFANSTIEHL STRAIN-SENSITIVE PICKUP and that from ordinary pickups is as great as the difference between good FM radio and AM radio reception.

There are good reasons why the PFANSTIEHL STRAIN-SENSITIVE PICKUP brings out the brilliance of truly great voices and orchestras... the latent music on your records that other methods of reproduction leave untouched.

- The PFANSTIEHL STRAIN-SENSITIVE PICKUP is an amplitude transducer with a CONSTANT RESISTANCE of about 250,000 ohms.
- Signal output is at a practically CONSTANT IMPEDANCE level.
- Excellent transient response.
- NO DISTORTION, phase shift or evidence of intermodulation apparent.
- LINEAR RESPONSE free from peaks or resonances.



ELEMENT (enlarged)



CARTRIDGE



QUICK CHANGE CARTRIDGE HOLDER

Cartridges for micro groove (.001 tip radius) and standard groove (.0027 tip radius) are available along with a Quick Change Cartridge Holder.

Styli are tipped with famous PFANSTIEHL M47B Precious Metal Alloy which will wear to less than a .003 flat in 100 plays on standard records at proper stylus pressure. Strain-Sensitive Elements equipped with Diamond styli are also available.

A special preamplifying circuit is necessary for operation of this new pickup. Four styles of preamplifiers with and without power supply and continuous tone controls are available, and are engineered to provide the correct polarized current for the pickup element, and also to provide the first stages of signal gain.

Proof of the excellence of the PFANSTIEHL STRAIN-SENSITIVE PICKUP is apparent both in tests and in actual listening, when its wide range flat response is best demonstrated. Ask your radio supply man or use the handy coupon below to get complete FREE INFORMATION.

P F A N S T I E H L
CHEMICAL COMPANY
(Metallurgical Division)

102 Lake View Avenue • Waukegan, Illinois

Pfanstiehl Chemical Company (Metallurgical Division)
102 Lake View Avenue, Waukegan, Illinois

Send me complete free information about the new PFANSTIEHL STRAIN-SENSITIVE PICKUP.

Name.....

Address.....

City, Zone & State.....

My Radio Supply House is.....

Address.....

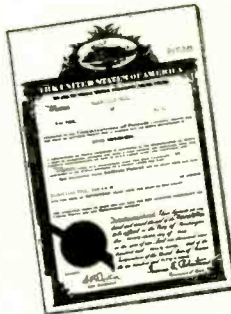

AUDIO PATENTS

RICHARD H. DORF*

It is very doubtful that there breathes anywhere a recording engineer who has not at one time or another spoken some very bad words in description of conventional volume indicators when they failed to indicate a large instantaneous peak and thus allowed the system to over-modulate and ruin a recording. Two things prevent decibel and VU meters from indicating the true amplitude of peaks—mechanical inertia and the fact that they operate from half-wave-rectified audio, thus being subjected in the first place only to either negative or positive peaks, but not both. John F. Clark has taken the lowly neon lamp, ordinarily used for volume indication only in nonprofessional equipment, and made a useful and precise instrument. The patent is numbered 2,494,643, and is assigned to RCA.

Two tricks make all the difference. First, not one but several lamps are used, each set to light at a different level. Thirteen of them, for example, might be arranged on a small panel, and as sound level rises, they would begin to light, starting with the one on the left; the rightmost lamp lighted would show the actual instantaneous level— instantaneous because the system is entirely electronic, thus inertialess. Such an arrange-

ment was used in early RCA Photophone film recording channels.

Figure 1 shows the schematic, with the usual amplifying equipment being employed for the recording circuits. A bridging transformer T_1 taps off some of the audio and feeds it to a two-tube preliminary amplifier V_1 and V_2 . Across the output of V_2 is a voltage divider with several taps. The full voltage goes through a pair of amplifier stages V_3 and V_4 , to a triode, the plate circuit of which contains the -45-db neon lamp. Thus, low-level signals will make that lamp light.

Lower taps on the divider go through amplifiers of progressively less gain as required to make succeeding lamps (up to the -6-db unit) light at the audio levels indicated.

As we get closer to zero or reference level, peaks become more important, since they may cause overmodulation. So far, the lamps have been driven by what is effectively a half-wave rectifying arrangement—the tube plate circuits. In speech and music, however, peaks may occur at random on either negative or positive side of the a.c. baseline; an indicator system driven by one of these will not read peaks on the other.

The answer is the full-wave bridge rectifier in Fig. 1. It is driven by V_1 and V_2 and

[Continued on page 65]

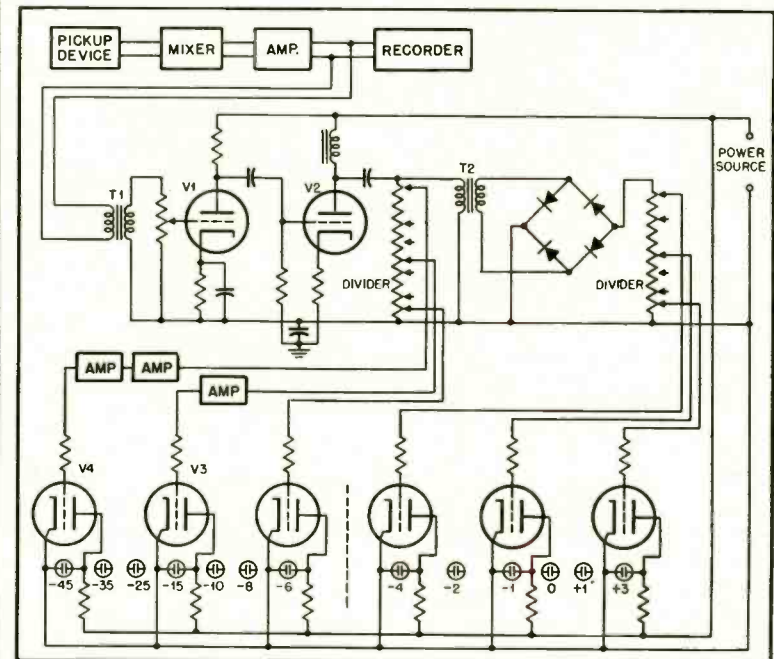

Fig. 1.

Intermodulation can be measured quickly and accurately with MEASUREMENTS' new, portable **MODEL 31**



INTERMODULATION METER



COMPLETELY SELF-CONTAINED

- TEST SIGNAL GENERATOR
- ANALYZER
- VOLTMETER
- POWER SUPPLY

To insure peak performance from all audio systems; for correct adjustment and maintenance of AM and FM receivers and transmitters; checking linearity of film and disc recordings and reproductions; checking phonograph pickups and recording styli; checking record matrices; adjusting bias in tape recordings, etc.

MEASUREMENTS CORPORATION meets the demand for compact, easily-operated intermodulation equipment! The MODEL 31 is moderately priced, yet extremely accurate and built to the same rigid specifications of all "LABORATORY STANDARDS".

One section of the MODEL 31 supplies mixed audio frequencies to the apparatus under test; the resultant signal from the apparatus is then applied to the analyzer section of the MODEL 31 to be filtered, amplified, demodulated and metered. The meter is direct-reading in percentage of intermodulation and input volts.

MODEL 30 INTERMODULATION METER

This model has a test generator providing, a low frequency range of 40, 70 and 100 cycles, a high frequency range of 2000, 7000 and 12,000 cycles, either separate or mixed in a 1/1 or 4/1 ratio.

The analyzer will operate from 20 cycles to 200 cycles and from 2000 cycles to 20,000 cycles.

A direct-reading meter measures intermodulation percentages from 0.1% to 30%; test generator output voltages from .01 to 100 v. (-30 to +20 DBM); analyzer input voltages from .0001 to 100 v. (-70 to +40 DBM).

Detailed circular on request

Specifications:

GENERATOR

LOW FREQUENCY: 60 cycles.
 HIGH FREQUENCY: 3000 cycles.
 LF/HF VOLTAGE RATIO: Fixed 4/1.
 OUTPUT VOLTAGE: 10 v. max. into high impedance or +5 DBM matched to 600 ohms.
 OUTPUT IMPEDANCE: 2000 ohms.
 RESIDUAL INTERMODULATION: 0.2% max.

ANALYZER

INPUT VOLTAGE: Full scale ranges of 3, 10 and 30 volts RMS. Less than one volt of mixed signal is sufficient for operation.
 INPUT IMPEDANCE: Greater than 400 K ohms.
 INTERMODULATION: Full scale ranges of 3, 10 and 30%.
 ACCURACY: $\pm 10\%$ of full scale.
 OSCILLOSCOPE connection at meter.

Power supply: 117 volts, 50/60 cycles, 30 watts. Dimensions: 8" high x 19" wide x 9" deep. May be mounted in standard 7" relay rack panel space. Weight: 16 lbs.

MEASUREMENTS CORPORATION

BOONTON NEW JERSEY

Saving energy for better low-cost telephone service



Arrow points to tube containing a wire specimen under test for surface conductivity. The tube and wire are excited to resonance by microwaves from generator at extreme left. Conductivity is calculated from frequency values indicated by barrel-shaped wavemeter (top center) and resonance curves traced on an oscilloscope screen (not shown).

In the waveguides which conduct microwaves to and from the antennas of radio relay systems, current is concentrated in a surface layer less than 1/10,000 inch thick, on the inner surface of the waveguide. When these surfaces conduct poorly, energy is lost.

To investigate, Bell radio scientists devised exact methods to explore this skin effect at microwave frequencies.

Scratches and corrosion, they found, increase losses by 50 per cent or more. Even silver plating, smooth to the eye,

can more than double the losses of a polished metal. Very smooth conductors, like electropolished copper, are best. An inexpensive coat of clear lacquer preserves initial high conductivity for many months.

Energy saved *inside* a microwave station is available for use in the radio-relay path *outside*. So stations can sometimes be spaced farther apart, and there will always be more of a margin against fading. Here is another example of the practical value of research at Bell Telephone Laboratories.

BELL TELEPHONE LABORATORIES



WORKING CONTINUALLY TO KEEP YOUR TELEPHONE SERVICE BIG IN VALUE AND LOW IN COST

Sensitivity, Directivity and Linearity of Direct Radiator Loudspeakers

HARRY F. OLSON*

In which the author shows that it is not desirable to obtain high sensitivity at the expense of smooth response, low distortion, and uniform directivity.

THE SENSITIVITY, DIRECTIVITY AND LINEARITY are interdependent in any direct-radiator dynamic loudspeaker. During the past decade, considerable emphasis has been placed upon high sensitivity with little regard for the factors of directivity and distortion. The reason for this state of affairs is that high sensitivity in a loudspeaker is easily demonstrated and more dramatic than the degradation of quality due to distortion and sharp directivity. As a consequence, smooth response, broad directivity, and low distortion have been sacrificed for sensitivity. For example, a loudspeaker with a high order of distortion and a narrow directivity pattern will sound louder than one with low distortion and a broad directivity pattern. However, a careful consideration will show that a more uniform directivity coupled with lower distortion at the sacrifice of sensitivity will lead to a superior loudspeaker. In order to make the analysis somewhat simpler, the considerations in this paper will be confined to single-element loudspeakers. However, the same conclusions will hold for multiple-unit systems.

Sensitivity

The efficiency¹, in per cent, of a direct-radiator dynamic loudspeaker is given by

$$\mu = \frac{(Bl)^2 r_{MA} \times 100}{[(Bl)^2 (r_{MS} + r_{MA}) + r_{EC} \times (r_{MC} + r_{MA})^2 + (x_{MA} + x_{MO} - x_{MS})^2]} \quad (1)$$

where B = flux density in the air gap, in gaussess,
 l = length of the voice coil conductor, in centimeters,

r_{EO} = electrical resistance of the voice coil, in abohms,

r_{MA} = mechanical resistance of the air load upon the cone, in mechanical ohms,

x_{MA} = mechanical reactance of the air load upon the cone, in mechanical ohms, and

r_{MS} = mechanical resistance of the suspension system, in mechanical ohms,

x_{MO} = mechanical reactance of the mass of the cone and voice coil, in mechanical ohms,
 $= j\omega m_c$

m_c = mass of the cone and voice coil, in grams,

X_{MS} = mechanical reactance of the suspension system, in mechanical ohms,

$$= \frac{l}{j\omega C_M}$$

C_M = compliance of the suspension, in centimeters per dyne.

For a particular diameter of the cone, r_{MA} and x_{MA} are fixed. For a fixed weight of magnet material and air gap, the flux density in the air gap is fixed. The air gap establishes the dimensions and mass of the voice coil. The remaining variable is the mass of the cone and the compliance and mechanical resistance of the suspension system.

From the above equations, it will be seen that the efficiency or sensitivity of a direct-radiator dynamic loudspeaker can be increased by reducing the mass of the cone.

The response-frequency characteristic of a typical commercial five-inch high sensitivity dynamic direct-radiator loudspeaker, designated as *A*, is shown in Fig. 1. It will be seen that the response at the low-frequency resonant peak is

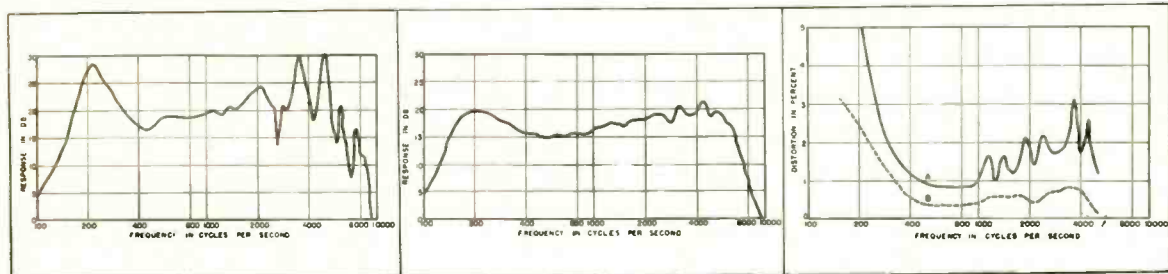

Fig. 1 (left). Response-frequency characteristic on the axis of a typical commercial 5-in. dynamic, direct-radiator loudspeaker, designated as (A). Fig. 2 (center). Response-frequency characteristic on the axis of a 5-in. loudspeaker with all the parameters the same as those of (A) except that the cone mass is two times that of (A) and the mechanical resistance of the suspension system larger than that of (A). Fig. 3 (right). Total harmonic distortion-frequency characteristics of loudspeakers (A) and (B). Power input to (A) is 0.2 watts; to (B), 0.4 watts.

* RCA Laboratories, Princeton, N. J.

¹ Olson, Elements of Acoustical Engineering, D. Van Nostrand Company, N. Y., 1947, p. 124.

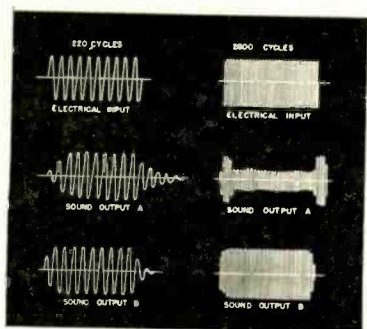

Fig. 4. Tone burst response of loudspeakers (A) and (B) at 220 and 2800 cps.

very high. In addition, the response-frequency characteristic is ragged in the high-frequency range. Both of these characteristics conspire to make the loudspeaker sound louder.

The response-frequency characteristic

of the cone. These break-up effects lead to a nonuniform response-frequency characteristic. The response in the low-frequency region is not as accentuated in loudspeaker B as in loudspeaker A. The response at the resonant frequency of loudspeaker B is reduced by a larger mechanical resistance in the suspension system.

Listening tests indicated that the sensitivity of loudspeaker A was about 3 db higher than B, which agrees with the response measurements of Figs. 1 and 2. Most loudspeakers today are evaluated by comparing response-frequency characteristics taken on the axis, or by means of listening tests in which the observation points are on or near the axis. In comparison of performance, sensitivity appears to be the principal consideration. However, careful listening tests will show that the distortion produced by loudspeaker A is very high as compared to loudspeaker B. The distortion

conditions, the sound output of the two loudspeakers will be the same. It will be seen that the harmonic distortion of loudspeaker B is very much less than A. This is to be expected, because the rigidity of the cone of B is at least eight times that of A.

Since all speech and music is of a transient character, the transient response is another characteristic which depicts the performance of a loudspeaker. Poor transient response leads to fuzzy reproduction with poor definition. As a result, the character of speech or musical instruments is destroyed.

A deviation in the sound output of a loudspeaker from the rapid growth and decay characteristics and the uniform steady state characteristics of an applied electrical tone burst depicts the transient response of the loudspeaker.

The responses of loudspeakers A and B to tone bursts at the resonant frequency of 220 cps are shown in Fig. 4.

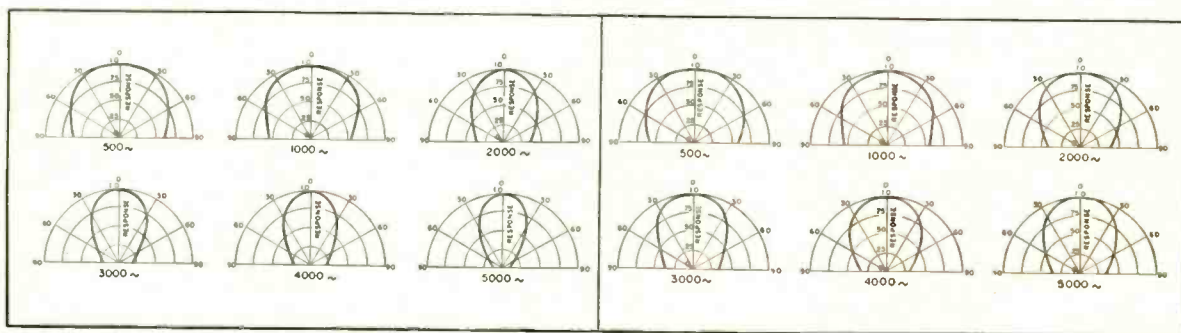

Fig. 5 (left). Directional characteristics of a typical commercial 12-in. dynamic direct-radiator, designated as (C). Fig. 6 (right). Directional characteristics of a 12-in. direct-radiator loudspeaker with a broad angle and processed cone, designated as (D).

of a five-inch loudspeaker, designated as B, with the same magnet structure and voice coil as loudspeaker A in the preceding example, but with a cone of two times the mass, and a suspension system with higher mechanical resistance is shown in Fig. 2. It will be seen that the general sensitivity is considerably lower than that of Fig. 1. The lower sensitivity comes about by reason of the larger cone mass. The effect of the larger mass of the vibrating system can be deduced from equation (1). The response-frequency characteristic of loudspeaker B shown in Fig. 2 is smooth. The smooth response is due to the greater stiffness and damping in the heavier cone of loudspeaker B. The stiffness is increased approximately eight times by doubling the mass, which in turn doubles the thickness. An increase in the stiffness of the cone reduces the "break-up" effects in

characteristics of these two loudspeakers will be examined in the next section.

Distortion

One of the effects of nonlinearity in the elements of the vibrating system of a loudspeaker is the production of harmonics and subharmonics. Nonlinearity in a cone occurs when the force vs. displacement characteristic deviates from a straight line. In a light-weight cone, this deviation occurs at a relatively small input.

The total nonlinear distortion frequency characteristic of loudspeaker A for an input of 0.2 watts is shown in Fig. 3. The total harmonic distortion-frequency characteristic of loudspeaker B for an input of 0.4 watts is also shown in Fig. 3. Note that the power input of B is doubled to compensate for the decreased sensitivity. Under these condi-

It will be seen that the transient response of loudspeaker A is superior to loudspeaker B, because the growth and decay are much faster. The responses of loudspeakers A and B to tone bursts at 2800 cps are also shown in Fig. 4. The transient response of loudspeaker A is poor. In general, a ragged response frequency characteristic, such as that exhibited by loudspeaker A (Fig. 1), indicates that it will exhibit poor transient response. The tone bursts of Fig. 4 demonstrate that the transient response of a loudspeaker with a nonuniform response-frequency characteristic will exhibit poor transient response.

Directivity

The directional characteristic of a loudspeaker is the response as a function of the angle with respect to some

reference axis of the system. The directional patterns are usually depicted in polar coordinates. The directivity of a piston-type radiator, such as a cone, becomes sharper as the ratio of the diameter to the wavelength increases. However, the directivity pattern can be controlled to a degree by the shape and the material of the cone.² If the directivity varies with frequency, frequency discrimination will result for points removed from the axis. In most loudspeakers, the high-frequency response is radiated in a narrow beam. Under these conditions, the high-frequency response is materially reduced when the observation point is a few degrees off the axis. Since a sharp directivity pattern is generally undesirable, the only reason for the existence of a loudspeaker with a sharp directivity pattern is to obtain high sensitivity on the axis. This will now be illustrated.

The directional characteristics of a typical commercial, twelve-inch, dynamic, direct-radiator loudspeaker, designated as *C*, are shown in Fig. 5. The directional characteristics of a twelve-inch dynamic, direct-radiator loudspeaker, with a broad directivity pattern, designated as *D*, is shown in Fig. 6. The open angle of the cone of loudspeaker *D* is wider than that of loudspeaker *C*. In addition, the cone is processed to reduce the velocity of sound propagation. These expedients conspire to yield a broader directivity pattern. It is quite obvious that the directivity pattern of loudspeaker *D* is far superior to that of *C*, because the frequency discrimination for points removed from the axis is far less severe than that of loudspeaker *C*.

The response-frequency characteristics of loudspeakers *C* and *D* are shown in Figs. 7 and 8. Since there is about the same amount of energy emitted by both loudspeakers, the loudspeaker with the sharper directivity will, of course,

²Olson, "Elements of Acoustical Engineering." New York: D. Van Nostrand Company, 1947, p. 47.

exhibit the highest response on the axis in the high-frequency region. However, for points removed from the axis, loudspeaker *D* will be superior. Unfortunately, both response and listening tests are usually made on the axis. Under these conditions, the loudspeaker with the highest response usually wins, even though from an over-all standpoint it is inferior.

Power Requirements

For home and other small-room sound reproduction, high sensitivity is not a requirement because the power available from the amplifier is more than adequate to obtain satisfactory sound levels. For example, the loudspeaker *B* of this paper will deliver a sound level of 80 db in the average living room for an input of .05 watt. Most amplifiers used in radio receivers and phonographs are of the order of 2 to 10 watts. In the case of loudspeaker *A*, the distortion is so high for inputs over 0.2 watts that the reproduction is not tolerable beyond this level, whereas loudspeaker *B* will handle much more power with tolerable distortion. In other words, the loudspeaker with the heavier cone and lower sensitivity used with conventional amplifiers will actually deliver more sound power before it overloads. Therefore, smooth response, low distortion, and a broad directivity pattern are more desirable than high sensitivity, because high sensitivity is of no practical value if it is obtained at the expense of low distortion and a broad directivity pattern.

Conclusion

The analysis in this paper has established that nonlinear distortion can be reduced and the response frequency characteristic smoothed by increasing the rigidity of the cone in a direct-radiator loudspeaker. Increased inherent stiffness of the cone can be obtained by the use of a thicker cone, which in turn

means a more massive vibrating system. A more massive vibrating system reduces the sensitivity. In this connection, it may be mentioned in passing there is nothing profound about the sensitivity of a direct-radiator loudspeaker. Greater sensitivity can be obtained either by a larger magnet or a lighter vibrating system. If the magnet size is the same in two loudspeakers, the one with the lightest vibrating system will show the greatest sensitivity. On the other hand, the power output for the same distortion is many times greater for the loudspeaker with the more massive vibrating system. In addition, the response-frequency characteristic is much smoother and the transient response is improved when a heavier cone is used. Therefore, when loudspeakers are compared in listening tests, the sound outputs should be adjusted to the same level before a comparison is made, because sensitivity is of secondary importance.

The analysis in this paper has also shown that a uniform directivity pattern with respect to frequency is more desirable than a directivity pattern which becomes sharper with increase in the frequency. The latter type of directivity produces frequency discrimination for observation points removed from the axis. For loudspeakers with well designed vibrating systems of the same mass and area and the same magnetic structure, the total sound output of the loudspeakers will be the same. Therefore, if the angular spread of the sound radiation is increased, the sound intensity on the axis will be reduced. In other words, the loudspeaker with the broader directivity pattern will appear to be less sensitive when the observation point is on the axis. Therefore, the directivity pattern is another factor that should be carefully checked by measurements or listening tests.

To summarize, this paper has shown that it is undesirable to obtain high sensitivity in a loudspeaker by sacrificing uniform response, good transient response, low nonlinear distortion, and uniform directivity.

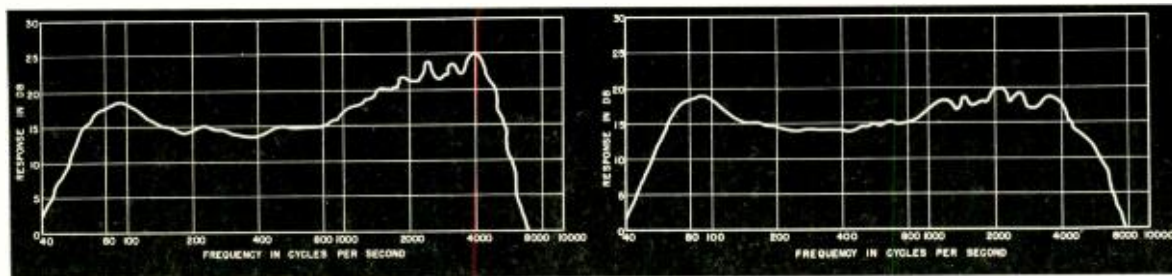

Fig. 7 (left). Response-frequency characteristic on the axis of the loudspeaker designated as (*C*). Fig. 8 (right). Response-frequency characteristics on the axis of the loudspeaker designated as (*D*).

Remote Installations

ELLIOT D. FULL*

One broadcaster's solution to the need for remote studio facilities with a maximum of operability and a minimum of cost.

A SMALL OR MEDIUM-SIZED unaffiliated broadcast station has one big advantage over larger network stations—it can program to its own trade area. If this advantage is exploited to its utmost a small station can more than hold its own against the talent, programming, and national advertising accounts of network stations. To compete effectively, small stations need to use varied live studio shows and a great number of remotes.

At KXIC this problem has taxed the ingenuity and ability of everyone in the engineering department. Here is a list indicating the variety of remotes we have done:

- Everyday program from farm editor's home
- Weekday programs from small studio in nearby town
- Short wave program while driving in a parade
- Man-on-the-Street on Saturday
- "Country Editor" from another small town
- Beep recorded news from still another town
- Short wave show from new swimming pool
- Community Building Teen-Club Saturday (with public address system for dancing)
- Two church remotes every Sunday
- A home talent show from a local theater Saturday mornings

We have built most of the specialized remote equipment ourselves partly for

economy reasons but mostly because of special design problems peculiar to the individual remote involved.

The amplifier for the Teen-Club has two microphone channels, a phonograph channel and a bridging public address system. The P.A. has two gain controls which are alternately switched in and out as the main microphone channel is switched. The P.A. gain controls can be pre-set to allow for a reduction in P.A. volume as the microphone is switched on. The system has performed excellently. It has been completely described elsewhere.*

The first two named remote systems involve ideas, both in programming and engineering, that have helped us to integrate the station more completely into the trade area.

Broadcast from Farm Editor's Home

The owners and our popular farm editor, G. M. Ludwig, decided that he ought to do an early morning broadcast from his home. The engineering department was simply requested to "hook it up."

Upon investigation we found that Ludwig lived a half mile from a small town that has a telephone "switchboard" designed by Martha Washington or one of her contemporaries. The patch cords were all frayed, the key switches on their last legs, and the repeat coils

about through repeating. Worst of all, the operator was not on duty before six in the morning. In addition to all this our farm man was twelfth and last man on the end of a ground-return country party line. We honestly felt that 10 watts of audio would not have overridden the "line" noise and the attenuation due to the other parties "rubbering" (listening-with low impedance ear-phones).

Since the party line curved around the countryside with Ludwig actually being fairly close to town, we decided to string an open-wire pair to the edge of town and to run a twisted pair on the local company poles from there to the exchange. When this job was done we repaired a drop that hadn't worked for years and connected in.

As can be seen from the Fig. 1, when the remote amplifier is turned on, Ludwig's phone is disconnected, the amplifier's output is connected to the line and about 50 volts simplexed onto the line. This potential operates a simplex relay at the phone exchange which "lifts" his line off the local exchange and connects him through to a larger nearby city which has full time operators and better equipment. Here a switch is thrown and connection made with Iowa City.

The amplifier is of conventional design and, for obvious reasons, of only medium fidelity. A reasonably good dynamic microphone is used. No volume indicator is provided. Cue is sent back from the station and picked up by Ludwig on earphones which he promptly discards as soon as the broadcast gets under way. Suffice to say, these early morning broadcasts have a large rural audience and have obtained amazing results for the sponsors.

Remote Studio Console

The small console shown in Fig. 2 is used in a town of about 5,000 some thirty miles south of Iowa City. This town Washington, Iowa had shown considerable interest in radio for quite a while. Since it is too small for the profitable operation of a commercial radio station we decided to put in a small studio and control room. This venture involved an element of risk, so a minimum-cost installation was thought desirable. The studio dimensions were

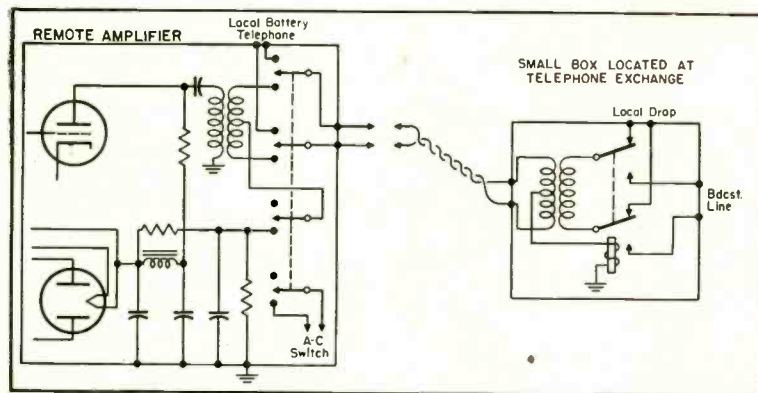

Fig. 1. Arrangement for remote amplifier so that telephone central office equipment is switched as required when amplifier is energized.

*Chief Engineer, KXIC, Iowa City, Ia.

*Communications, October, 1949.

designed around the cube root of two as far as possible and a reverberation time in the studio of about 0.8 seconds was planned. Because of heavy floor traffic in the store above, a totally isolated ceiling was included. The double walls were lined inside with acoustical block and polycylindrical surfaces.

The console had to be very simple from the operation standpoint and yet it had to control (1) an "A" mike, (2) a control-room mike, (3) an on-the-street mike, (4) a turntable. In addition, it had to allow for receiving cue from the control room in Iowa City on the speakers, and to cut each speaker when its associated mike was live. We also provided a 10-watt bridging amplifier for speakers in the lobby, in the store above, and one we hope to install in the town square. The on-the-street and "A" mike outlets are paralleled. When Mangold does a man-on-the-street program, he removes the "A" mike, turns on the "A" channel, and sets its gain slightly

Fig. 2. Small studio console made up for use in one of the remote installations.



controlled by the same switches since the speaker level would rarely exceed zero db.

As a result of these simplifications, the

talk to "A". The turntable switch auditions in the up position.

Again the equipment was not designed for very high fidelity—(30 miles of grade D line). An RC circuit was included in the program amplifier to give a rise of about 6 db at 5000 cps to compensate partially for the line. This allowed us to terminate the line in our console directly without using an equalizer at the station. We can, therefore, talk back and forth on the line without going through the 20 db loss a regular equalizer might insert.

"One-Man" Operation

Francis Mangold, who runs the shows in Washington, had previously been our news correspondent there. With the studio installation he had to learn to sell radio time, announce, carry on a fifteen minute man-on-the-street show and keep sponsors on the air. Needless to say he was very, very happy to find he did not have to learn to manipulate a "maze of knobs, dials, and buttons" in addition to his other duties. We carry three 15-minute shows daily from there and the advertisers are quite pleased with the results.

The circuit diagrams of both units described were purposely left out. Every station has its own problems and fidelity requirements; therefore each should custom design equipment of this type.

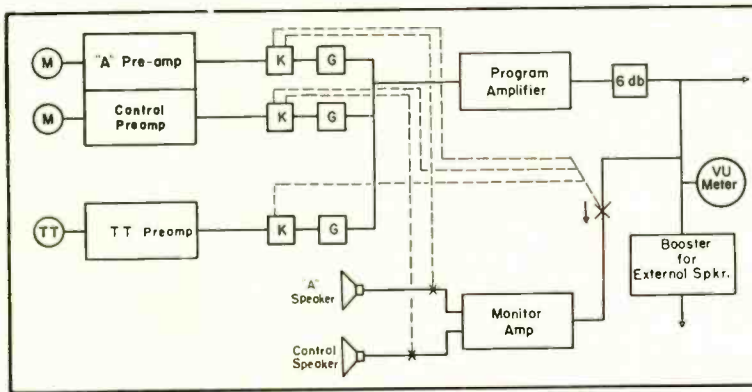

Fig. 3. Block diagram of console shown in Fig. 2.

lower than normal. On the street he plugs his mike into the outlet located on the front of the store, and plugs a pair of earphones into a jack which is connected across the Iowa City line. This arrangement eliminates the need for a control board operator.

Switching relays were unnecessary since the mikes and the turntable were switched as seen in Fig. 3 at the output of their preamplifiers, a level of -40 db. The studio and control speakers were

console panel contained only three switches, one meter and three mixer controls. The small associated relay rack contains only a monitor control, a program control, a booster standby switch, and an off switch.

In the up position the studio "A" key switch allows the person in "A" to talk to control. In neutral the mike is off, when down it is on the air. The control room switch is used in the same way except when up, it allows the operator to

OCTOBER

26
27
28

THE AUDIO FAIR

1950—Hotel New Yorker

Optimum Use of Nickel Alloy Steels in Low-Level Transformers

L. W. HOWARD*

A statement of the problems involved in making a line of high-quality transformers, and a useful bibliography on transformer design.

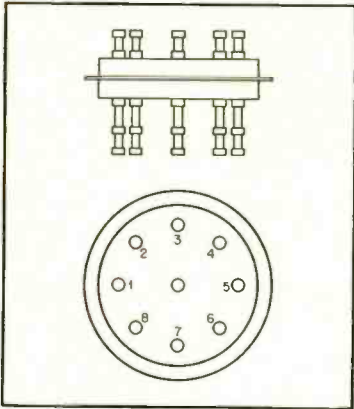

Fig. 1. Terminal arrangement which permits an adequate number of connections for multilead transformers.

THE PROPERTIES OF THE NICKEL ALLOY series of lamination steels which make them desirable for use as core materials and as a shielding material for low-level transformers have been known and commercially applied for a good many years. By a series of relatively small gains in the design techniques, the engineers in the industry have attained results which, when accumulated over a long period of time, represent major advancement in performance. Application of all of these new developments in any given application is frequently limited by economic considerations, the necessity for making use of expensive dies already purchased, the losses involved in obsolescing stocks on hand, etc. It is all too infrequent that any group of engineers has the opportunity to review all advances in technique, select the most adaptable to the problem under consideration, and to tool from scratch with no limitations due to use of dies already on hand. Such a development program is described in this article.

Since new tooling was involved, it became desirable to review all possible uses for such tooling and to make each

die serve a purpose in each of several possible lines.

A tentative series of designs was developed for each of three fields of application in which the properties of the nickel alloy series afford promise of improved operation. A group of dies were then laid out to adapt themselves best to these designs. The groups of transformers around which this development grew were as follows:

A. Low-level wide-range transformers.

The high permeability of the nickel alloy steels at very low levels makes them particularly desirable for use in wide-range designs. High inductance values are obtainable without excessive leakage inductance or capacitance being developed, even when such transformers show relatively high gain. If full advantage is taken of this feature, a wide-range low-level transformer can be built into a very small space.

B. Transformers for geophysical prospecting equipment.

Geophysical equipment involves a different series of objectives in that only very low frequencies need to be considered, but low phase shift, high inductance, high gain, and above all, exact reproduction of characteristics, are of major importance. The equipment is portable in application, and as more and more channels are crowded into a typical prospecting truck, small size and weight become secondary in importance only to the electrical performance. A very high degree of shielding is required because of the high gain and sensitivity at line frequencies. All of these requirements are best met by use of properties of the nickel alloy steels.

C. Miniature components.

Using the high permeability of the nickel alloy steels to attain a reasonable amount of inductance in a small space permits the manufacture of transformers for practically all low-level applications with sizes which are only a fraction of that required for normal transformers designed for the same purpose. Since most of the equipment is battery operated

and response at line frequencies is greatly attenuated, the shielding problem is not acute.

Common Problems

Problems which were common to the three groups were as follows:

A. **SIZE:** In all of the types of equipment for which these transformers are designed, extreme portability where obtainable without sacrifice in performance is desirable. Tooling was set up to reduce size and weight to the absolute minimum

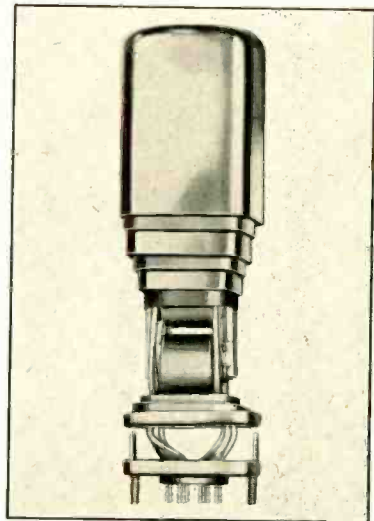

Fig. 2. Transformer case composed of nested alternate layers of nickel-alloy and copper shields.

in all types. External cases were also to be shielding cases, to eliminate even one thickness of electrically inactive material.

B. **MOISTURE PROTECTION:** It was felt that wartime developments in hermetic sealing, as exemplified in the JAN-T-27 specifications, provided a good standard. Satisfactory terminals of molded, mineral-filled, low-loss phenolic were available but did not provide an adequate number of terminals in the small area available in the new miniature series of cases. Two new types were therefore

* Triad Transformer Mfg. Co., 2254 Sepulveda Blvd., Los Angeles 64, Calif.

developed, providing, respectively, nine terminals in 23/32 in. diameter and twelve terminals in 7/8 in. diameter. These seals use sturdy turret-type studs molded into the plastic and with their identifying number molded nearby as shown in Fig. 1. Soldering techniques and vacuum apparatus for impregnation and filling of the transformers were already included in the production equipment available.

C. MAGNETIC SHIELDING: The problems of shielding against stray fields and of the external case must be considered together when minimum size is to be maintained. Previous experience had indicated that a maximum of three high-permeability nickel alloy shields, interleaved with heavy copper shading rings, would be necessary to provide the reduction in pickup of stray fields needed for the lowest level transformers. Due to the wide range in transformer size and handling capacity, it was necessary to provide seven sets of case dies, each usable either as an external case or as an interior shield. These cases were designed so that the smaller cans nest within the larger with room between for the heavy copper shading rings, as shown in Fig. 2.

The equipment used in checking shielding efficiency is also of interest. As illustrated in Fig. 3, the transformer is positioned on the platform in the center of the Helmholtz coil, the large diameter of the coil ensuring a weak and uniform field for testing. Standard procedure is to check the transformer in two planes at right angles to each other, the results being strictly comparative with a similar unshielded unit.

D. FREQUENCY RANGE: The transformers involved in this problem are divided into three groups:

1. *Wide-range components.* It was felt that a minimum standard of 20 to 20000 cps ± 1 db should be maintained. Where wider range could be attained without increase in size or weight, this was done.
2. *Geophysical components:* Depending upon portability in the particular piece of equipment to be designed, 5 to 500, 10 to 500, or 20 to 500 cps, ± 1 db were determined as standards. Several designs were to be available for each standard function. Where possible without sacrifice of other desirable characteristics, frequencies above 1000 cps were to be attenuated.
3. *Miniature components:* Nickel alloy cores were used to attain minimum size rather than wide frequency range. The voice frequency range of 250 to 5000 cps, ± 1 db, is all that is considered necessary.

E. HANDLING CAPACITY: The nickel

Fig. 3. Equipment used for testing efficiency of transformer shielding.

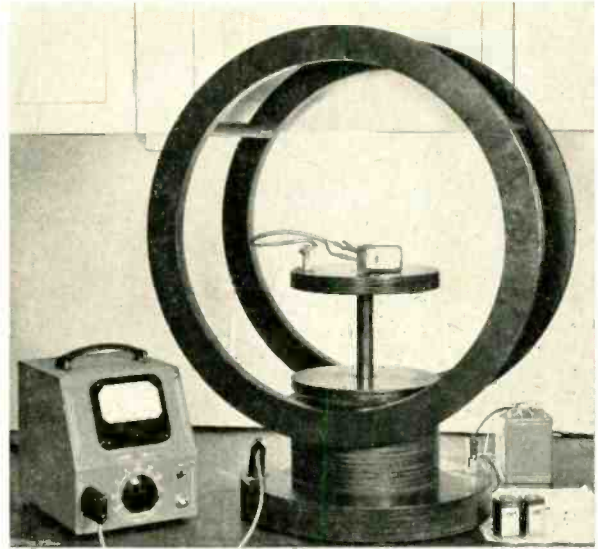

alloys are not too useful in the larger transformers due to their low saturation point. High-quality silicon steels are therefore more adaptable to high-level output transformer designs. Generally speaking, transformers in the groups described in this article were in the operating range below 20 VU.

Conclusions

Since it is important that size be held to a minimum in all types, extremely accurate winding equipment and great skill in winding are necessary to handle the fine wire sizes which must be used. Such fine wire coils open up easily under moist conditions or mechanical movement. Therefore it is urgent that the windings be completely dried and all voids filled with non-hygroscopic and non-acid material. Only the most highly developed of vacuum-treating equipment is satisfactory. We have also found it almost imperative that the transformers

be hermetically sealed and filled with compound under vacuum.

Possibly the emphasis placed on minimum size in this article seems overdone; however, not only is size important in the applications where these transformers are used, but keeping physical dimensions to a minimum permits reduction in leakage inductance and in capacity, thus permitting a more extended frequency range. Figure 4 shows a series of transformers made in a variety of case sizes.

The attached bibliography covers a number of articles which have appeared in the Proceedings of the Institute of Radio Engineers. The audio design chapters in Dr. Terman's "Radio Engineering" and "Radio Engineers Handbook" are also particularly helpful.

BIBLIOGRAPHY

- All references to *Proc. I.R.E.*
 Manfred Von Ardenne, "On the Theory of Power Amplification," Feb. 1928.
 J. M. Thomson, "Characteristics of Output Transformers," Aug. 1928.
 Glenn Koehler, "The Design of Transformers for Audio-Frequency Amplifiers with Pre-Assigned Characteristics,"* Dec. 1928.
 V. D. London, "A Bridge Circuit for Measuring the Inductance of Coils While Passing Direct Current," Dec. 1928.
 John Minton and Ioury G. Maloff, "Design Methods for Soft Magnetic Materials in Radio," June 1929.
 E. L. Chaffee, "Equivalent Circuits of an Electron Triode and the Equivalent Input and Output Admittances," Sept. 1929.
 H. M. Turner, "Inductance as Affected by the Initial Magnetic State, Air-gap and Superposed Currents," Oct. 1929.
 Arthur E. Thiessen, "The Accurate Testing of Audio Amplifiers in Production," Feb. 1930.
 C. E. Kilgor, "Graphical Analysis of Output Tube Performance," Jan. 1931.
 H. J. Reich, "A New Method of Testing for Distortion in Audio-Frequency Amplifiers," March 1931.

[Continued on page 50]



Fig. 4. Complete line of transformer cases for units of various sizes.

A New Loudspeaker of Advanced Design

DANIEL J. PLACH* and PHILIP B. WILLIAMS**

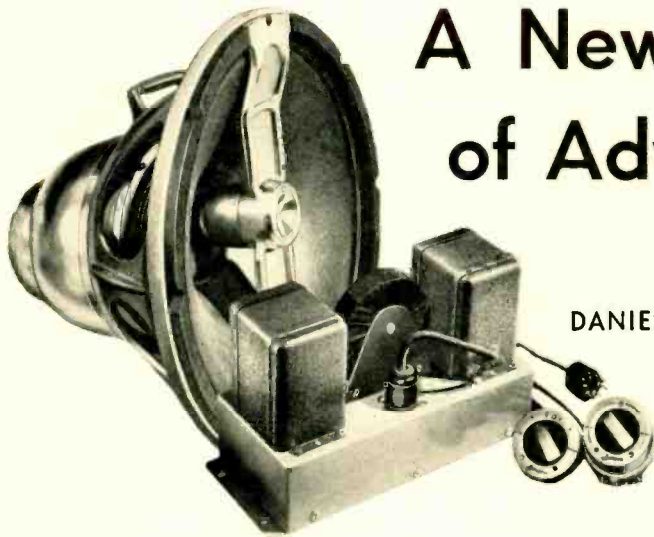

A description of a new unit which was designed for the most critical applications in sound reproduction.

WITH THE ADVENT of better audio sources, the performance requirements of loudspeakers have become more stringent. Improved studio equipment for FM and AM, the development of high-quality magnetic tape, and the introduction of microgroove recordings have offered extended range material requiring a loudspeaker of greatly improved performance. Response range is but one of the essential considerations. In addition, the following requirements must be met:

1. Smooth response
2. Balanced response
3. Good spatial distribution
4. Good transient response
5. Low distortion
6. Satisfactory efficiency
7. Adequate power handling capacity

Existing materials suitable for use in loudspeaker diaphragms have mass and stiffness limitations which make it impossible for a single-channel system to conform to all the previous requirements. Quasi-two-channel systems employing a single voice coil, a conventional cone, and a thin metal dome are notably deficient from the standpoint of transient response, range, and efficiency. This type of radiating system is productive of harshness and "edginess" attributable to unsuppressed resonant modes in the metal dome.

Inherent advantages of the compression or horn type radiator, as shown in Fig. 1, make its use desirable in the upper spectrum of multichannel systems. Because of horn loading of the diaphragm, it is possible to attain extremely high efficiencies and smooth response. The large degree of loading attainable makes it possible to reduce distortion by decreasing the diaphragm excursion for

a given amount of sound power output. The improvement results from reduction of non-linear distortion effects arising from movement of the voice coil beyond the region of uniform flux density and prevention of movement of the diaphragm suspension into the region of non-linear stiffness. By proper configuration of the horn mouth and flare, it is possible to attain very good spatial distribution over a large part of the operating frequency range.

Here, too, practical limitations apply. It can be shown from energy considerations that the displacement of the diaphragm with applied signal is:

$$X = \frac{1}{2\pi f} \sqrt{\frac{nP_e \times 10^7}{R_h}} \quad (1)$$

where X = diaphragm displacement in cm.

f = frequency in cps.

n = efficiency

P_e = electrical power input in watts

R_h = effective load on diaphragm in mechanical ohms

Equation (1) shows that the displacement varies inversely as frequency and therefore becomes large at low frequencies. Consequently, to reproduce low frequencies at substantial powers, the clearance between sound chamber and diaphragm must be relatively large. Clearance also must be kept large compared to the displacement to avoid serious distortion effects due to compressibility of the air and non-linear viscosity effects. At the same time, the moving system must be a dependable mechanical device, capable of undergoing the required motions for indefinitely long service without structural failure.

A horn-type loudspeaker can be treated as a band-pass filter. From considerations of equivalent circuits of horn units

as in Fig. 1, the high-frequency cutoff is given by:

$$f_c = \frac{1}{2\pi} \sqrt{\frac{S_c}{M_d}} \quad (2)$$

where f_c = cutoff frequency in cps

S_c = stiffness of sound chamber air volume in dynes per centimeter

M_d = dynamic mass of moving system in grams

Above f_c the sound output falls off rapidly. For efficient reproduction at high frequencies, equation (2) shows that the mass must be held to an absolute minimum and the sound chamber stiffness made large. The latter is accomplished by use of comparatively small sound chamber clearances.

Thus it can be seen that satisfactory power handling capacity at lower frequencies and high efficiency at high fre-

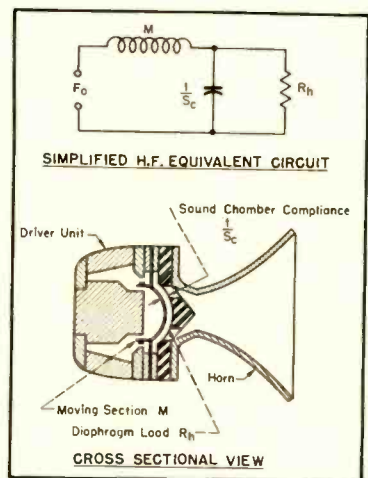

Fig. 1. Compression-type high-frequency unit.

* Physicist and ** Senior Engineer, Jensen Manufacturing Co., Chicago, Ill.

quencies are requirements which are not compatible over a wide frequency range. An additional complicating factor is that distortion increases in proportion to the frequency span which is attempted in a single unit. It was accordingly considered impractical to attempt to cover the entire middle- and high-frequency range satisfactorily with a single unit. Examination of commercial tweeter units intended to cover three or more octaves clearly confirms the predicted limitations on bandpass width at this stage of the acoustical art. Objective measurements indicate that an all too prevalent commercial practice is to design for sufficient mass and clearance to allow satisfactory lower-frequency performance and then greatly to overrate the actual high-frequency response.

Design Objectives

As a result of these considerations, verified by considerable experimental work, an extensive program was undertaken to lead to the development of a compact three-channel loudspeaker which would satisfy the eight requirements previously listed. Intended uses were to include high-quality monitoring from live material, tape recordings, custom-built radio phonographs, FM reception, and any other application where the finest possible performance is essential. It was also to serve as a tool for the development and subjective testing of audio components and equipment. However, to allow its use with source material of limited range and noticeable distortion and noise, provision was to be made to adjust high-frequency cutoff to the capabilities of the source.

All acoustic elements were to be properly integrated into a unitary structure in which electrical and space phasing problems were resolved before installation. Such a design would then be free from the detrimental effects encountered in physically separated radiating systems. The first crossover frequency was to be set at the lowest possible value consistent with the dimensions of the integrated structure in order to maintain piston-like behavior over the entire range of the low-frequency unit. A desirable goal was set at 600 cps. This figure was to be the actual attained acoustic crossover rather than the theoretical electrical crossover. The latter figure is sometimes given and does not necessarily reflect the actual system behavior.

The mid-channel radiator would have a sufficiently large horn mouth area for smooth reproduction down to 600 cps, and at the same time maintain wide-angle radiation up to the second crossover frequency, which was ultimately established at 4000 cps.

Considerable commercial experience

Fig. 2. Cross-sectional view illustrating arrangement of the three channels.

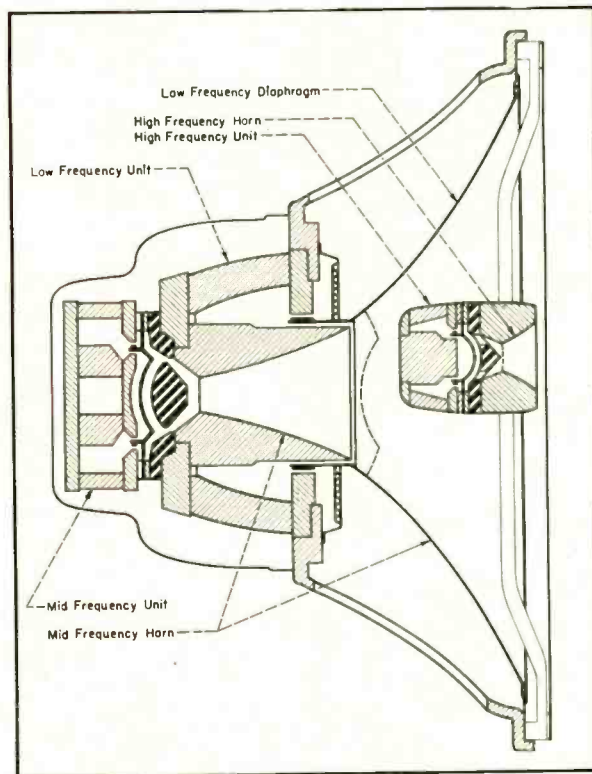

and long continued transducer development programs resulted in the decision to use plastic diaphragms in compression units of the G-610. The high internal damping characteristic of phenolic material discourages undesirable modes of vibration that are detrimental to faithful transient response. This durable material tends to be free from the sharp resonances and "birdies" that are typical of metallic diaphragms.

It was considered necessary to utilize extraordinary powerful magnetic structures to attain high efficiency and good transient performance. High flux density in itself does not produce high efficiency. The volume of voice coil conductor in this flux field is also a factor. For this reason, total magnetic energy is a preferable criterion of magnetic efficiency. A minimum total energy of 36 million ergs appeared desirable from these considerations.

Design Achievement

The Jensen Model G-610 Triaxial three-way loudspeaker system is the result of intensive development directed toward the attainment of these objectives. It consists of a loudspeaker composed of three independently driven reproducers and a separate control and crossover network.

The low-frequency unit covers the frequency range to 600 cps. The radiating

surface is a 15-inch Hypex formula^{1,2} curved cone driven by a massive three-inch diameter voice coil. Complete freedom from hangover effects and boominess is provided by efficient utilization of a 6½-pound Alnico V magnet providing airgap energy of 30 million ergs. The unusually large spider and rigid cone were designed to achieve good linearity and low distortion even at high operating levels.

The mid-frequency unit employs a rigid re-entrant type phenolic diaphragm with an annular takeoff passage and driven by a two-inch voice coil. Because of the limited frequency range in this channel, it has been possible to use a rugged two-gram moving system and very large clearances, resulting in great peak power handling capabilities and low distortion. Through the use of a dual concentric magnet arrangement, a high airgap energy is provided in a small volume of magnetic material with airgap flux density of 17,500 gauss. This driver is coupled into a Hypex horn as shown in Fig. 2. The initial section of the horn passes through the core of the low-frequency channel, and the final section is formed by the curved cone. The large effective horn mouth size provides good loading, resulting in smooth response at high efficiency down to and

[Continued on page 62]

¹ Electronics, July, 1941.
² Patent 2,338,262.

"Williamson" Type Amplifier Using 6A5's

J. H. BEAUMONT*

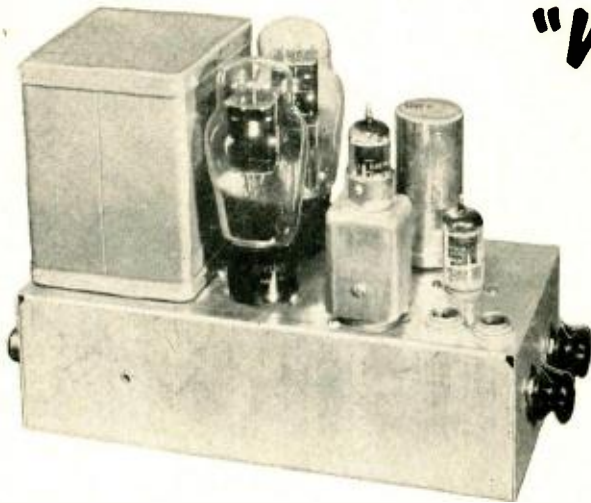

Figure 1

A simple and effective amplifier based on the now-familiar circuit originally appearing in "Wireless World."

THE CONTINUALLY INCREASING POPULARITY of the Williamson amplifier among music lovers and technicians alike prompts another version of this circuit, the third to appear in this country. Designed for 6A5's, it will not deliver as much power to the speaker as either of the others; but use shows its nominal rating of six watts to be ample for home use. The arguments for and against large reserve power have never been resolved among engineers, and no attempt will be made to do so here. The low-power amplifier is regaining its popularity after having been nearly lost in the welter of claims that grew up around amplifiers using the 6L6 and the attendant fanfare about 25- and 30-watt outputs. There is no particular need for arguing that there should *not* be as large a power reserve as is reasonably possible since most circuits exhibit greatly improved distortion and linearity characteristics when they operate well below their ratings, but it is worth considering that the average power delivered to the speaker for "normal" room volume in the usual living room is of the order of 6 milliwatts, as has been established by tests. On this basis, the thousand-to-one reserve ratio of this amplifier seems adequate. If an efficient speaker is used, the amplifier will produce more volume than most listeners can tolerate, with sufficient reserve to maintain clean reproduction of any music.

The original plan was to provide a fixed gain package which would operate from a preamplifier containing all the necessary controls. However, the idea of a self-contained preamplifier seemed so attractive that it was added to the design, with consequent modifications in the circuit. To avoid an additional stage

of gain, high- μ triodes were used for inverter and driver stages. The direct-coupled inverter was changed slightly to conform to the configuration of the direct-coupled preamplifier in order to preserve uniformity and to ensure the excellent characteristics which have been observed with this arrangement in several circuits. Direct-coupled pairs, which are a characteristic of the Williamson, are seldom seen in amplifier service, though their use for this purpose was established in this country as long ago as 1940.¹ The configuration shown here has been used for some five types of stages with considerable satisfaction. The cathode circuit of the 6A5's had to be modified because the cathodes in these tubes are tied to the filaments. There are no other major changes from the original circuit. The output transformer chosen was a Freed F-1951, which gives excellent results. Miniature tubes were used in place of octals because of the higher μ available in this series. Figure 1 shows the external appearance of the complete amplifier.

Preamplifier Description

Starting at the input plug, let us consider those parts of the circuit that merit discussion. The preamplifier, which is constructed in a Vector plugin can, is a familiar circuit which has been modified slightly for direct coupling. Its operating characteristics remain essentially the same as the capacitance-coupled version. Referring to the schematic, Fig. 2, the input grid resistor, R_{11} , was set at 0.1

meg because this value works well with the General Electric cartridges which were used with this amplifier. When other cartridges are to be used, it is preferable to use the values specified by the manufacturer for flat response.

R_1 and C_s form a compensating network in the feedback loop to eliminate the tendency of this preamplifier circuit to droop at frequencies above the crossover point, a condition which is inherent to the circuit since the crossover point is located on the knee of the compensation curve produced by the feedback-loop components. When this droop is added to that often found in cartridges and present even in amplifiers which are rated flat, the result can be as much as a 5-db drop at frequencies between crossover and 5,000 cps. This is sufficient to be noticeable, and has an effect of reducing the brilliance of music. The compensating network tends to decrease the feedback as frequency increases, thus offsetting the droop. Values for these components may have to be varied to suit an individual amplifier, but normally the capacitor should have a reactance of about ten times R_3 at the crossover frequency. If the response rises, the value of the capacitor should be decreased; if response drops off, C_s should be increased. R_1 may vary between the value of R_3 and one-half that value, increasing if there is a rise at 10,000 cps, and decreasing if there is a droop at this point.

Adjustment of the network was made with a Cook Series 10 frequency record so that the cartridge would be included. The pickup used with this amplifier exhibits excellent response characteristics with the Cook record, showing no more

¹C. G. McProud and R. T. Wildermuth, "Direct-coupled input stage for phase inversion in audio amplifiers," *Electronics*, October 1940.

* 49 Beach St., New York, N. Y.

than plus or minus 1-db variation through 10,000 cps.

The preamplifier may be built on a regular Vector socket if the plug-in feature is not desired. However, the preamplifier plug-in socket may be used as a source of power for an external preamplifier if at any time it is desired to use one, and plug-in preamplifiers allow changes to be made without disturbing the internal wiring. The circuit shown here is the third used with this amplifier since its construction was started. It is worth noting that if the octal socket is used as a source of external power there can be no heater grounds in the external equipment because the heater string is connected to the 6A5 cathodes and is "off ground" by the amount of their bias. If a separate heater pair is supplied on the power supply used with the amplifier, it may be wired to the preamplifier socket, though in general, the d-c bias on the heater string is considered desirable.

Parts mounting on the post of the Vector unit will be much simplified if the screw joining the parts is taken out and the octal plug removed entirely. This allows the post to be rotated so that its lugs are conveniently located with respect to the novel socket lugs. Components which pass into the octal base, such as C_4 , should be fastened at one end and plenty of lead length left on the other. Leads from the lugs to the socket are fastened to their lugs and left projecting below the end of the post far enough to pass through the octal pins. Fiber-glass sleeving should be used on leads only where one crosses another, or comes near a lug; the rest of the wiring may be done with bare wire. Figure 3

shows the appearance of the preamplifier, both cased and uncased.

When all wiring and soldering is complete, the octal plug is re-assembled and all leads passed through their respective pins. When the screw has been tightened, the lead ends are cut off flush with the pins and soldered. If a layout is made before assembly is undertaken, it is possible to arrange the parts so that all the leads will pass almost straight from the post into the plug pins. The ground lug on the base of the can should be connected to the common ground point of the preamplifier.

The remainder of the stages were wired on Vector sockets because they offered an interesting approach to parts mounting which could be completed stage by stage and inserted in the chassis with all leads attached. This simplifies assembly greatly, and the resulting job will be both compact and neat, as shown in Fig. 4. This type of mounting avoids the troubles often found in getting strip mountings to operate satisfactorily due to the necessarily greater length of critical leads. The only critical leads leaving the Vectors are the grid leads of the following stage, and the capacitors may be hung from one socket to the next if these give trouble.

Further ease in assembly can be obtained by using a 6x10 Bud Minibox in place of the chassis indicated here. These boxes come in two sections, one of which forms the top and ends of a chassis, and the other the sides and bottom. Work on the top section can be done, unhampered by sides, and the completed unit will be housed in a neatly finished box.

Moving into the amplifier proper, R_{15}

and R_{16} provide isolation for the two inputs and R_{36} is the gain control. The amplifier-inverter stage has the same basic configuration as the preamplifier and requires no comment, except that R_{18} and R_{19} should be a matched pair to obtain as nearly a balanced output as possible. C_6 and C_7 were intentionally made small in value in order to preserve a smooth bass response down to the low-

PARTS LIST

R_1, R_1	2200 ohms, ½ watt
R_3, R_4	3900 ohms, ½ watt
R_5, R_6	10,000 ohms, 1 watt
R_7, R_8	47,000 ohms, 1 watt
R_9, R_{10}	68,000 ohms, 1 watt
R_{11}, R_{13}, R_{15}	0.1 meg, ½ watt
$R_{12}, R_{13}, R_{14}, R_{17}, R_{19}, R_{21}, R_{23}$	0.1 meg, 1 watt
R_{18}, R_{19}	0.1 meg, 1 watt, 5%
R_{24}, R_{25}	0.27 meg, ½ watt
R_{26}, R_{27}	0.47 meg, ½ watt
R_{28}, R_{29}	4 ohms, 2 watt, 5%
R_{30}, R_{31}	1.0 ohms, 2 watt
R_{32}	350 ohms, 10 watt wire-wound
C_{1a}, b, c, d	2-20-20-450 v, electrolytic
C_2, C_3	(.1 µf, 400 v, Aerolite
C_4, C_5	.1 µf, 400 v, Aerolite
C_6, C_7	.104 µf, 400 v, Aerolite
C_8, C_9	.102 µf, 400 v, Aerolite
T_1	Output transformer, Freed F-1951
V_1, V_2, V_3	2AX7
V_4, V_5	6A5
P_1, P_2	Amphenol 80-C
P_3	Jones P-202
P_4	Jones P-306-AB
P_5	Octal socket, Amphenol MIP-8
	Vector B8-N socket ass'y (1 req)
	Vector 10-O-9T, (2 req)
	Vector 8-N-9T (2 req)
	Aluminum chassis, 5x10x3

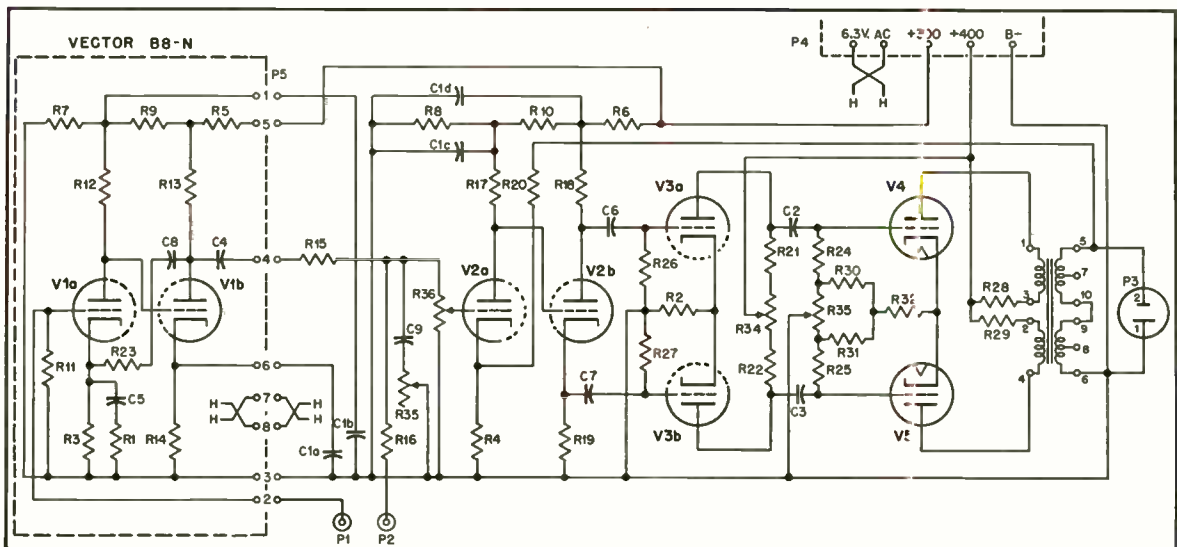

Fig. 2. Complete schematic of the 6-watt amplifier described.

est frequency because feedback loops around two or more stages usually require that some adjustment be made within the loop to avoid response peaks at the frequency extremes, with consequent oscillation. A simple means of achieving this is to make the response of one stage poor with respect to the others.² There seemed to be no need of special components to reduce the high-frequency response, and the amplifier exhibits excellent stability throughout its range.

C_o and R_{3s} provide a controllable high-frequency roll-off. These values provide approximately 20-db loss at 10,000 cps. This is ample to provide proper equalization for long-playing records. No high boost was desired, or considered advisable. When the response of a system can be made truly flat to at least 20,000 cps there should be no need of high boost. All long playing records require de-emphasis; most shellac records of recent vintage have pre-emphasis added, and will require a certain amount of de-emphasis. In other cases, surface noise becomes excessive when boost is used to capture highs on a record where they are deficient.

No bass control is provided in this design at all. If one is desired it may be added either internally or as part of an external preamplifier. It can be shown that a satisfactory bass compensation can be worked out for virtually all records so far as their recording characteristic is concerned,³ and that the crossover frequency may be adjusted by listening preference. Beyond this there is a legitimate doubt that control is needed, except to compensate for low listening levels which may best be done in any case with a loudness control. While it is true that records vary in bass response, so do live concerts, and this variation should be considered as a normal part of listening. An amplifier should have a clean and flat response down to its lowest frequency to assure

² F. E. Terman, "Radio Engineer's Handbook," p. 397 ff, 1st Edition. New York: McGraw-Hill Book Co., 1943.

³ Howard T. Sterling, "Simplified Preamplifier Design," AUDIO ENGINEERING, November 1949.

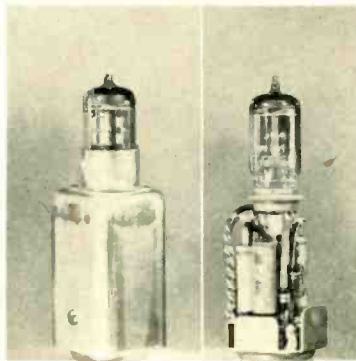

Fig. 3. The plug-in preamplifier, cased (left) and with the case removed (right).

the clarity of bass reproduction, which is more important than any amount of volume.

R_{3s} in the plate circuit of the driver serves to balance the signals to the grids of the 6A5's. Should any serious unbalance occur when the control is at its mid-point, preceding circuits and tubes should be checked. R_{3s} equalizes the plate currents of the 6A5's by adjusting a portion of the bias voltage to which the grid returns (R_{2s} , R_{2s}) are connected. The balance is read by connecting a milliammeter at the points marked 2 and 3 on the output transformer. Balance within a few microamperes can be obtained when the circuit is warm. R_{3s} and R_{2s} must be matched within 1 per cent to ensure an accurate reading, and 10 per cent resistors may be matched on a bridge to find a pair. This method was used because cathode metering cannot be used with 6A5's—their cathodes being effectively tied together by the filament wiring.

No power supply is shown inasmuch as none was built specifically for the amplifier. The supply voltages shown on the schematic may be obtained from any well designed supply. With these voltages the amplifier is in a somewhat overbiased Class A condition. If the 6A5 supply voltage is reduced to 300 volts and R_{3s} adjusted to give 45 volts bias from cathodes to ground, the tubes will

then be operating at their rated Class A point.

The strapping of the output transformer shown in Fig. 2 is for a speaker load of 16 ohms. Other strappings may be determined from the instructions accompanying the transformer. The feedback, using the component values indicated, will be approximately 5 db. The amplifier is stable under all conditions observed, and the driving conditions are such that more feedback would have required more gain elsewhere in the circuit for full output, which did not seem desirable. The over-all response of the equipment is essentially flat from 35 to 20,000 cps, using the Cook record, and the listening quality of the amplifier fully validates the superiority of the Williamson circuit.

NAB Inaugurates Voice of Democracy Contest in Schools

A series of five "model" talks have been transcribed by prominent national figures for the 1950-51 Voice of Democracy Contest, it was announced recently by the VOD Committee Chairman Robert K. Richards.

Voices to be heard in the 4-4½ minute programs, currently being pressed by RCA, are those of Supreme Court Justice Tom C. Clark, VOD Honorary National Chairman, (speaking on "Platform for Democracy"); Senator Edwin C. Johnson (D), Colo., (speaking on "Democracy at Work"); NAB President Justin Miller (speaking on "Freedom of Expression"); U. S. Commissioner of Education Earl J. McGrath (speaking on "Education for Democracy"); and Representative Brooks Hays (D), Ark., vice-president, Southern Baptist Convention, (speaking on "Freedom of Worship").

NAB member stations will begin Oct. 1 to receive the transcriptions to be scheduled during National Radio and Television Week, Oct. 29-Nov. 4, as guides for students competing.

Guide manuals of procedures and rules for the Fourth Annual VOD Contest for the best broadcast scripts by high school students are currently being mailed to all NAB stations, 28,000 high schools, and Junior Chamber of Commerce chapters. These manuals outline the deadline dates of the contest and suggest means of cooperation between local representatives of the three sponsoring organizations in promoting the event. The sponsors are the National Association of Broadcasters, the Radio-Television Manufacturers Association, and the U. S. Junior Chamber of Commerce. The competition is endorsed by the U. S. Office of Education, Federal Security Agency.

The contest for students in the second, third and fourth years of high school, now entering its first phases, will reach a climax during National Radio and Television Week, and culminate in a national awards luncheon on Washington's birthday in Feb. 1951, at which time \$500 college scholarship awards will be made to the four national winners.

Not an oratorical or essay contest, the competition is judged by broadcasting standards, with special weight given to content, delivery and originality. National and state judging is done by transcriptions made by local radio stations.

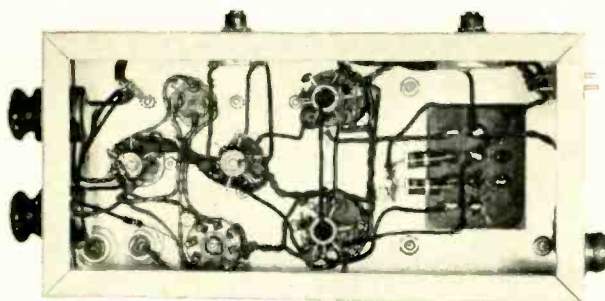

Fig. 4. Under chassis view of the amplifier. Note the neatness resulting from the use of Vector sockets.



Audio Engineering Society,
Box F, Oceanside, N. Y.

AUDIO engineering society

Containing the Activities and Papers of the Society, and published monthly as a part of AUDIO ENGINEERING Magazine

OFFICERS

Theodore Lindenberg, President

J. D. Colvin . . . Executive Vice-Pres. John G. Frayne . . . Western Vice-Pres.
Norman C. Pickering Secretary Ralph A. Schlegel Treasurer

Automatic Audio Gain Controls

J. L. HATHAWAY*

A discussion of the development and application of program-controlled circuits in broadcasting, with a description of a general-purpose AAGC amplifier in regular use.

MANY OF THE AAGC's in service are necessarily of compromise design. For example, in extremely portable battery-operated equipment, such as radio mikes or pack transmitters, it is hardly practical to utilize all of the refinements of a high-quality studio control unit. A tiny transmitter cannot devote sufficient filament power or bulk to push-pull control tubes and balancing transformers so that a single-sided system is generally used. This leads to a condition of regeneration or degeneration, depending on the number of stages, and also to creation of severe pop components. The general cure for both of these ailments is the same—the use of an extremely slow attack time around 50 to 100 milliseconds. Although it might seem that this would render the control virtually useless, such is not the case. Tests on high-level input to units incorporating even this imperfect control show that great benefit is derived as compared to similar equipments without any form of automatic control. Without the control, overmodulation becomes serious and causes the “rasping” type of distortion which is disagreeable and at the same time intelligibility is reduced. With the control, the rasping distortion is eliminated, and quality, except for a few slight pops, is generally good. Furthermore, average level may be increased many db when the AAGC is employed.

Dual Controls

Applications wherein extremely wide level variations are likely to occur call for double-action control. Our studio units are of this type and some of these are used without manual assistance as, for example, in news flash booths. The philosophy leading to the development of these dual controls was basically as

* National Broadcasting Company, New York.

Fig. 5. Top view of ND-333 AAGC amplifier.

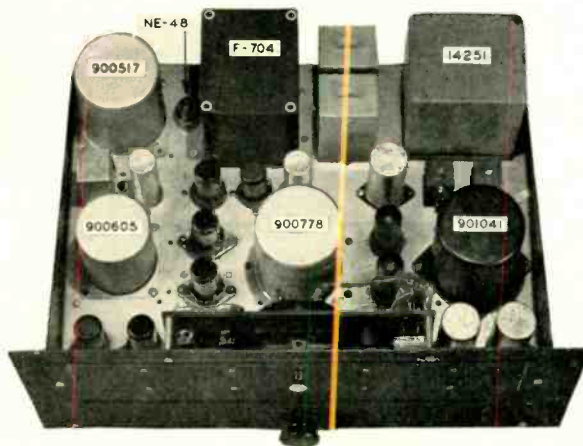

follows: with normal input, a limiter type of control would be thoroughly satisfactory. But suppose a speaker were close to the microphone and also had louder-than-normal voice—the microphone output might easily be 20 db or so above normal. This condition frequently exists in practice, especially when the speaker must override a high ambient acoustical noise level. Thus, peak gain reductions of 20 to 22 db are not uncommon, and this is too much for an ordinary limiter since gain rises too rapidly during slight pauses, producing a continual rising and falling effect which removes syllable emphasis and creates an unnatural and displeasing sound. If, however, control adjustment were made slowly in the microphone circuit ahead of the limiter, the rapidly rising gain during pauses would be evident only during the first few spoken words, that is, during the transition period prior to attenuation of average level by the first circuit. Thereafter the input level would be held down to just slightly above normal. If long pauses existed, the input would slowly restore gain towards maximum. Thus the func-

tioning of such a double circuit might be likened to a person's neck and eye action wherein he glances only with the eyes at objects which are to be viewed but momentarily. When prolonged viewing is called for, the neck automatically turns to relieve the eyes of most of their displacement after which the eyes are in better position for continued viewing. The slow averaging of the dual control is thus similar to neck action, whereas the rapid limiting is similar to eye action.

Units employing two controlled stages have served satisfactorily in studio operations for the past twelve years. These operate with the first stage functioning on average level. The second stage, having a rapid attack time, is always available for conventional limiting. Recently, in order to simplify and further improve this double action, designs have utilized a double-time-constant circuit operating in a single controlled stage. Here two radically different time constant RC circuits are operated in series in such manner that a small capacitor is quickly charged by a single peak in the control rectifier. A much larger capacitor is slowly charged, requiring many peaks to

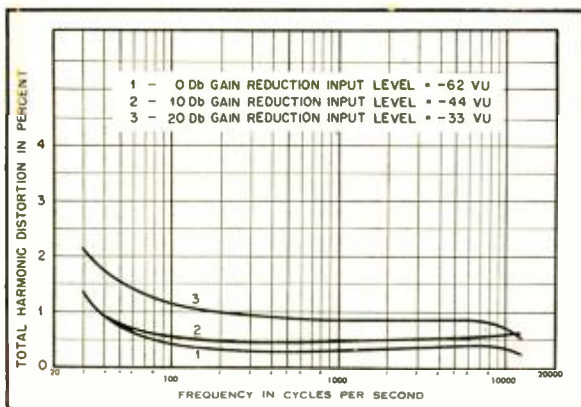

Fig. 6. Harmonic distortion curves for ND-333 amplifier under different operating conditions.

was received which could not be overlooked. The producer on one of the dramatic shows believed that the unit was holding pistol shots down too low in level. He liked its action otherwise but wanted to hear the sound-effect shots louder and have them indicate full scale on the VU meter—the engineer had always been able to achieve this without the automatic control. He agreed that the broadcasting station limiter would reduce most of the excessive peak level but still wanted a more realistic effect in the control and clients booths. Therefore, a short study of pistol shot acoustical characteristics was conducted by viewing oscilloscope patterns. The main portion of the pistol shot proved to be extremely short, in the order of 15 milliseconds. Such a short burst at normal amplitude does not sound loud, nor does it register fully on a VU meter. In order to make it indicate and sound full, the amplitude must be increased several fold. With this in mind, a special circuit was invented and installed in the unit to create the desired effect. Figure 7 is a complete schematic of the ND-333 AAGC, showing the pistol shot accentuating circuit at the upper right portion. A crystal rectifier converts a sample of the high-intensity sound potential to a negative d.c. pulse which is coupled to the grid of a triode amplifier. The crystal is biased to conduct only when the input level is 24 db above threshold, a condition existing only on pistol shots as far as we can determine, assuming some degree of manual control. The negative pulse on the grid results in a positive plate pulse, which in turn ignites the neon lamp and momentarily decommissions the control circuit.

ND-333 Application

The new studio control unit is highly effective and multifold in purpose. It permits 6- to 8-db higher average output onto the telephone lines feeding both

the local and remote broadcast transmitters. It permits a more even over-all control of level, and unless its action is purposely overridden by the control engineer, makes it unnecessary for millions of listeners to continually jump to adjust the volume controls on millions of radio receivers throughout the country. It gives improved television sound through increased transmission level and uniformity. It prevents excessive levels on telephone long lines, which otherwise cause severe distortion. Broadcasters sometimes feel that the long-lines personnel are supercritical of level. It must not be too high or too low or they call master control to insist on something being done about it. At Radio City some of these AAGC units have been available for just this type of emergency. An engineer on a complicated show may have ten or more microphones to keep properly mixed—a producer shouting instruction, a script to follow, and in addition a PA system to control as well as over-all output level. When "long lines" calls master control and they in turn call this one-armed paper hanger two or three times to bring up level or hold down peaks, he becomes slightly confused. Then, in the deliberate atmosphere of the transmission room, someone says "Here's a rubber amplifier for him," silently inserting patch cords to replace the uncontrolled studio amplifier. Calm returns to the master control room, no more calls come from the supercritical long liners, and in the control booth the operator suddenly has no more trouble delivering a sufficiently high level without the VU meter hitting hard off scale. Above all, thanks to Automatic Audio Gain Control, the listener whose baby sleeps upstairs hears every word of his favorite program without worry of a floor walking session.

In conclusion, a great deal of credit and thanks should go to Mr. Raymond Lafferty of the NBC Engineering Development Group for his skill and diligence in the development and application of the ND-333.



Employment Register

EMPLOYMENT OPPORTUNITIES may be listed here at no charge to industry or to members of the Society. For insertion in this column, brief announcements should be in the hands of the Secretary, Audio Engineering Society, Box F, Oceanside, N. Y. before the first of the month preceding the date of issue. Replies to box numbers should be addressed to AUDIO ENGINEERING, 342 Madison Ave., New York 17, N. Y.

★ Positions Open

● Positions Wanted

★ **BRAZIL:** We have an opening for an electronic engineer who would like to come to Brazil and become a partner in an old established high-class service organization. Want man with all around knowledge of receivers, amplifiers, test equipment, electronic heating, and general application of electronics. Capital required, about \$500. São Paulo is the fastest growing city in South America. Genial climate. Food plentiful. Assured future for a good man of about 30. Knowledge of Portuguese not essential. References exchanged. Box 1001.

★ **Wireman,** instrument, capable of building models and occasional short production runs of precision electronic devices. Must be able to work with minimum of supervision. Permanent; write giving salary expected, family status, availability. Box 1002.

★ **WANTED:** Signal Corp Center, Fort Monmouth, N. J. has openings in the following Civil Service positions:

Military Instructors—Microwave relay, radar, radio electronics, fixed station radio, central office techniques, teletype installation and maintenance, repeater and carrier, dkl central office maintenance, theory of electricity. \$3100-4600.

Electronic Engineers—Participate in design, development, modification, construction, and testing of electronic equipment—radio, radar, wire communications, instrumentation sonar, etc. Responsibility depending upon experience and ability. \$3100-6400.

Technical Writers—Write, edit, prepare technical publications, handbooks, circulars, instruction books, etc. Edit and revise scientific manuscripts on radio, radar, electronics, communications, and photography. Write instruction manuals on theory, operation, and maintenance of Signal Corps equipment; determine media and method of presentation of material; prepare charts, graphs, schematic diagrams etc. \$3100-5400.

Applicants for any of these positions should write Chief, Civilian Personnel Branch, Signal Corps Center, Fort Monmouth, N. J., submitting a completed Standard Form 57, "Application for Federal Employment" (obtainable at any first or second class post office) for review before going to Fort Monmouth for a personal interview.

the

PRESTO PT-900

America's finest
portable tape recorder

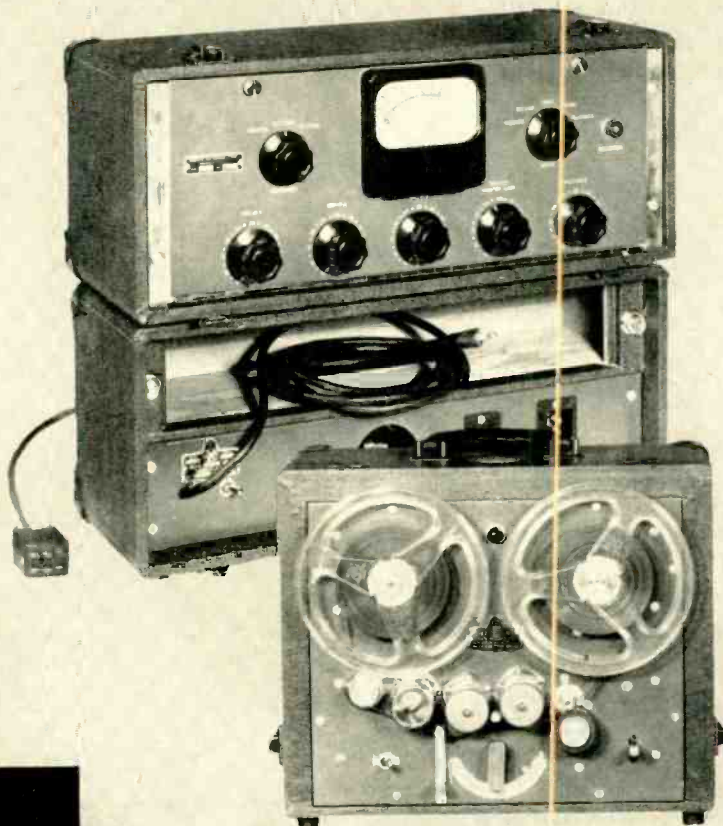

Look at these features:

- Three heads for recording, playback, erasing.
- Separate recording and monitoring amplifiers.
- Three microphone input.
- Speeds: 15" and 7½"/sec.
- Frequency response: 50-15,000 cps.
- Power supply and amplifier in separate, leatherette covered cases.

The PRESTO PT-900 has been chosen by discriminating engineers, educators and broadcasters throughout the country as the best constructed, best performing, most durable, portable tape recorder available today. Combining the features of machines costing hundreds of dollars more, the PT-900 answers the need for a recorder of ultra-high fidelity in a completely portable, compactly designed unit. Built by the world's largest manufacturer of recording equipment and discs, the PRESTO PT-900 is precision engineered for years of satisfying service.

 **PRESTO** RECORDING CORPORATION
Paramus, New Jersey

In Canada: Walter P. Downs, Ltd., Dominion Square Bldg., Montreal, Canada
Overseas: M. Simons & Son Co., Inc., 25 Warren Street, New York, N. Y.

THE AUDIO FAIR — 1950

Directory of Exhibitors

The largest exhibition of audio equipment ever assembled under one roof opens Thursday, October 26th at 9:30 a.m. on the fifth and sixth floors of Hotel New Yorker, with a total value of displays well in excess of a quarter of a million dollars. Visitors to the first Audio Fair will remember that all records were broken—an attendance of over three thousand at the Convention and exhibit of a Society with a membership at that time of less than one thousand.

The entire sixth floor is occupied with the displays of forty-three exhibitors, and fifteen rooms on the fifth floor are taken at the time of going to press. This

represents an increase of approximately fifty per cent over the first Fair, and provides considerably more space for the visitors—particularly since many of the exhibitors have increased their space appreciably.

Newcomers to the second Audio Fair include Gates Radio Company, Tetrad, FM & TV Magazine, United Transformer Company, Audio-Master, Browning, Bell Sound Systems, Inc., Measurements Corp., Herman Hosmer Scott, Inc., Triad Transformer, Fisher Radio, Radio & Television News, Electronics of Staten Island, The Langevin Company, and Cinema Engineering Com-

pany. The jobbers exhibiting at the 1950 Audio Fair include: Sun Radio, Harrison, Midway, Sonocraft, Terminal, Harvey, Hudson, Milo, Arrow, and Leonard Radio, ensuring a wide variety of radio and electronic components in addition to the products of the manufacturers who are exhibiting in their own rooms.

The Audio Fair only lasts for three days—including one evening—and then a whole year elapses until the next one. To make sure of seeing everything in the audio field, come early and often, but be sure and *Come to the Fair*.

ALTEC LANSING CORPORATION 618-619

Hollywood, California
161 Sixth Ave., New York
Products: Speakers, microphones, tweeters, AM-FM tuners, home music systems.

IN ATTENDANCE

H. S. Morris Dave Sonkin
Mel Sprinkle Marty Wolf

AMPEX ELECTRIC CORPORATION 614-615

San Carlos, California
Products: Ampex Tape Recorders.

IN ATTENDANCE

Charles E. Rynd Russell O. Hudson
W. O. Summerlin

AMPLIFIER CORP. OF AMERICA 531

396-398 Broadway, New York
Products: Magnetic tape recorders, high-fidelity phono amplifiers; electrical test equipment.

IN ATTENDANCE

N. M. Haynes, *Chief Engr.*
M. R. Ellis
P. H. Frankel
R. Epstein
Sidney Karr
Ph. Kootman
Frank Kosinski

ARROW ELECTRONICS 646

82 Cortlandt St., New York
Products: Lowther-English speakers; Sonar Radio Corp. equipment; Audio Labs of Phoenix, Arizona; amplifiers, speakers, pickups, and audio equipment.

IN ATTENDANCE

Murray Goldberg, *Pres.*
Charles Ray, *Sound Dept. Mgr.*
Jack Kirshbaum
Emery Jusztus, *England*
Jack Babkes

AUDAK COMPANY, INC. 642-643

500 Fifth Avenue, New York
Products: Electronic reproducers; Polyphase and Tuned Ribbon pickups; recording cutters.

IN ATTENDANCE

Maxmillan Weil, *Pres.*
A. Weberg, *Technician*
J. V. Sullivan, *Vice Pres.*

AUDIO DEVICES, INC. 651

444 Madison Ave., New York
Products: Audiocassettes (recording discs); Audiopoints (recording and playback styli); Audiotape (magnetic recording tape).

IN ATTENDANCE

William C. Speed, *Pres.*
Bryce Haynes, *Vice Pres.*
C. J. LeBel, *Vice Pres.*
Herman Kornbrodt, *Regional Sales Mgr.*

AUDIO FACILITIES CORPORATION 647

133 W. 14th St., New York
Products: Artificial Reverberation Generator (Represented by Tech Laboratories, Inc.)

IN ATTENDANCE

M. Bjorndahl E. Bjorndahl
G. Van Baaren A. L. Budd
G. Harris W. Richards
K. Meri

AUDIO INSTRUMENT COMPANY 630

133 W. 14th St., New York
Products: Intermodulation sets, Bridgers, Disc-Noise meters, Logarithmic amplifiers, condenser microphone preamplifiers, microphone equalizers.

IN ATTENDANCE

C. J. LeBel, *Chief Engr.*
A. C. Hendricksen
F. M. Conte

THE AUDIO-MASTER COMPANY 644

23 W. 45th St., New York
Products: Recording equipment, microphones, playback machines.

IN ATTENDANCE

Herbert Rosen

AUDIO & VIDEO PRODUCTS CORP. 614-615

1650 Broadway, New York
Products: Ampex tape recorders.

IN ATTENDANCE

Charles E. Rynd, *Pres.*
W. Oliver Summerlin, *Vice Pres., Engr.*
Russel O. Hudson, *Vice Pres.*
Kenneth B. Boothe, *Eastern Sales Mgr.*

BALLENTINE LABORATORIES, INC. 526

Boonton, N. J.
Products: Electronic voltmeters.

IN ATTENDANCE

Charles L. Gawler Walter A. Knoop
Harry C. Gawler Allyn W. Janes

BELL SOUND SYSTEMS, INC. 618

555 Marion Road, Columbus, Ohio
Products: Hi-fidelity amplifier, tape recorders, and other allied equipment.

IN ATTENDANCE

Floyd W. Bell, *Pres.*
H. H. "Pete" Seay, Jr., *Vice Pres. & Gen'l. Mgr.*
L. Evans, *Engr.*
E. Sisson, *Chief Engr.*

BERLANT ASSOCIATES 529

4917 W. Jefferson Blvd., Los Angeles, Calif.
Products: Concertone magnetic tape recorder.

IN ATTENDANCE

Emanuel Berlant Avery R. Fisher

BRITISH INDUSTRIES CORP. 650

161 Duane St., New York
Products: Garrard record changers; Leak "Point One" amplifiers; Wharfedale speakers.

IN ATTENDANCE

Leonard Carduner, *Pres.*
G. A. Briggs
Frank Hoffman
Eugene Carduner
H. J. Leak
Wm. Lichter

BROWNING LABORATORIES, INC. 645

750 Main St., Winchester, Mass.
Products: Tuners—FM and AM-FM.

IN ATTENDANCE

Glenn H. Browning, *Pres.*
S. S. Egert, *Representative*
John Mandel, *Representative*
Ralph L. Purrington, *Vice Pres.*
J. Fields, *Representative*

BRUSH DEVELOPMENT CO. 619

(Burlingame Associates, 103 Lafayette St., New York)
Products: Soundmirror magnetic tape recorders.

IN ATTENDANCE

J. H. Munchausen B. O. Burlingame

BURLINGAME ASSOCIATES 640

103 Lafayette St., New York
Products: Hewlett-Packard audio test equipment; Brush Development Co. Instruments; Tektronics, Inc. Oscilloscopes.

IN ATTENDANCE

Bruce O. Burlingame
A. J. Novak, *Brush Dev. Co.*
Roland Reisley, *Engineer*
Jack Grand
M. J. Lichtenstein, *Field Engr.*
Robert Asen, *Field Engr.*

[Continued on page 42]

New 1951 • • MODEL V-4A

Heathkit VTVM KIT

HAS EVERY EXPENSIVE Feature

- ★ Higher AC input impedance, (greater than 1 megohm at 1000 cycles).
- ★ New AC voltmeter flat within 1 db 20 cycles to 2 megacycles (600 ohm source).
- ★ New accessory probe (extra) extends DC range to 30,000 Volts.
- ★ New high quality Simpson 200 microampere meter.
- ★ New ½% voltage divider resistors (finest available).
- ★ 24 Complete ranges.
- ★ Low voltage range 3 Volts full scale (½ of scale per volt).
- ★ Crystal probe (extra) extends RF range to 250 megacycles.
- ★ Modern push-pull electronic voltmeter on both AC and DC.
- ★ Completely transformer operated isolated from line for safety.
- ★ Largest scale available on streamline 4½ inch meter.
- ★ Burn-out proof meter circuit.
- ★ Isolated probe for dynamic testing no circuit loading.
- ★ New simplified switches for easy assembly.

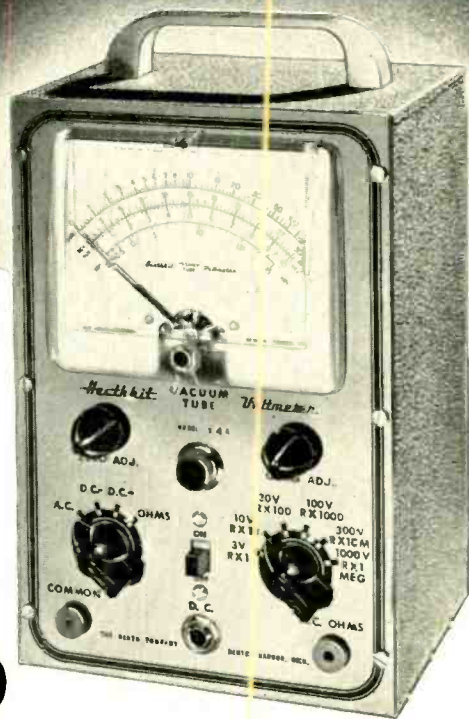

New
LOW PRICE **\$23.50**

The new Heathkit Model V-4A VTVM Kit measures to 30,000 Volts DC and 250 megacycles with accessory probes — think of it, all in one electronic instrument more useful than ever before. The AC voltmeter is so flat and extended in its response it eliminates the need for separate expensive AC VTVM's. + or - db from 20 cycles to 2 megacycles. Meter has decibel ranges for direct reading. New zero center on meter scale for quick FM alignment.

There are six complete ranges for each function. Four functions give total of 24 ranges. The 3 Volt range allows 33½% of the scale for reading one volt as against only 20% of the scale on 5 Volt types.

The ranges decade for quick reading.

New ½% ceramic precision are the most accurate commercial resistors available — you find the same make and quality in the finest laboratory equipment selling for thousands of dollars. The entire voltage divider decade uses these ½% resistors.

New 200 microampere 4½" streamline meter with Simpson quality movement. Five times as sensitive as commonly used 1 MA meters.

Shatterproof plastic meter face for maximum protection. Both AC and DC voltmeter use push-pull electronic voltmeter circuit with burn-out proof meter circuit.

Electronic ohmmeter circuit measures resistance over the amazing range of 1/10 ohm to one billion ohms all with internal 3 Volt battery. Ohmmeter batteries mount on the chassis in snap-in mounting for easy replacement.

Voltage ranges are full scale 3 Volts, 10 Volts, 30 Volts, 100 Volts, 300 Volts, 1000 Volts. Complete decade coverage without gaps.

The DC probe is isolated for dynamic measurements. Negligible circuit loading. Gets the accurate reading without disturbing the operation of the instrument under test. Kit comes complete, cabinet, transformer, Simpson meter, test leads, complete assembly and instruction manual. Compare it with all others and you will buy a Heathkit. Model V-4A. Shipping Wt., 8 lbs. Note new low price, \$23.50.



**New 30,000 VOLT DC
PROBE KIT**

Beautiful new red and black plastic high voltage probe. Increases input resistance to 1100 megohms, reads 30,000 Volts on 300 Volt range. High input impedance for minimum loading of weak television voltages. Has large plastic insulator rings between handle and point for maximum safety. Comes complete with PL55 type plug.

No. 3366 High Voltage Probe Kit.
Shipping Wt., 2 pounds.

\$5.50

**Heathkit
RF PROBE KIT**

Crystal diode probe kit extends range to 250 megacycles — 10% comes complete with all parts, crystal, cable and PL55 type plug.

No. 309 RF Probe Kit.
Shipping Wt., 1 lb.

\$5.50



EXPORT DEPT.
13 East 40th St.
NEW YORK CITY (16)
CABLE: ARLAB-N.Y.

The HEATH COMPANY

... BENTON HARBOR 25, MICHIGAN

AUDIO DESIGN NOTES

CHART SHOWING WAVELENGTH FOR AIR

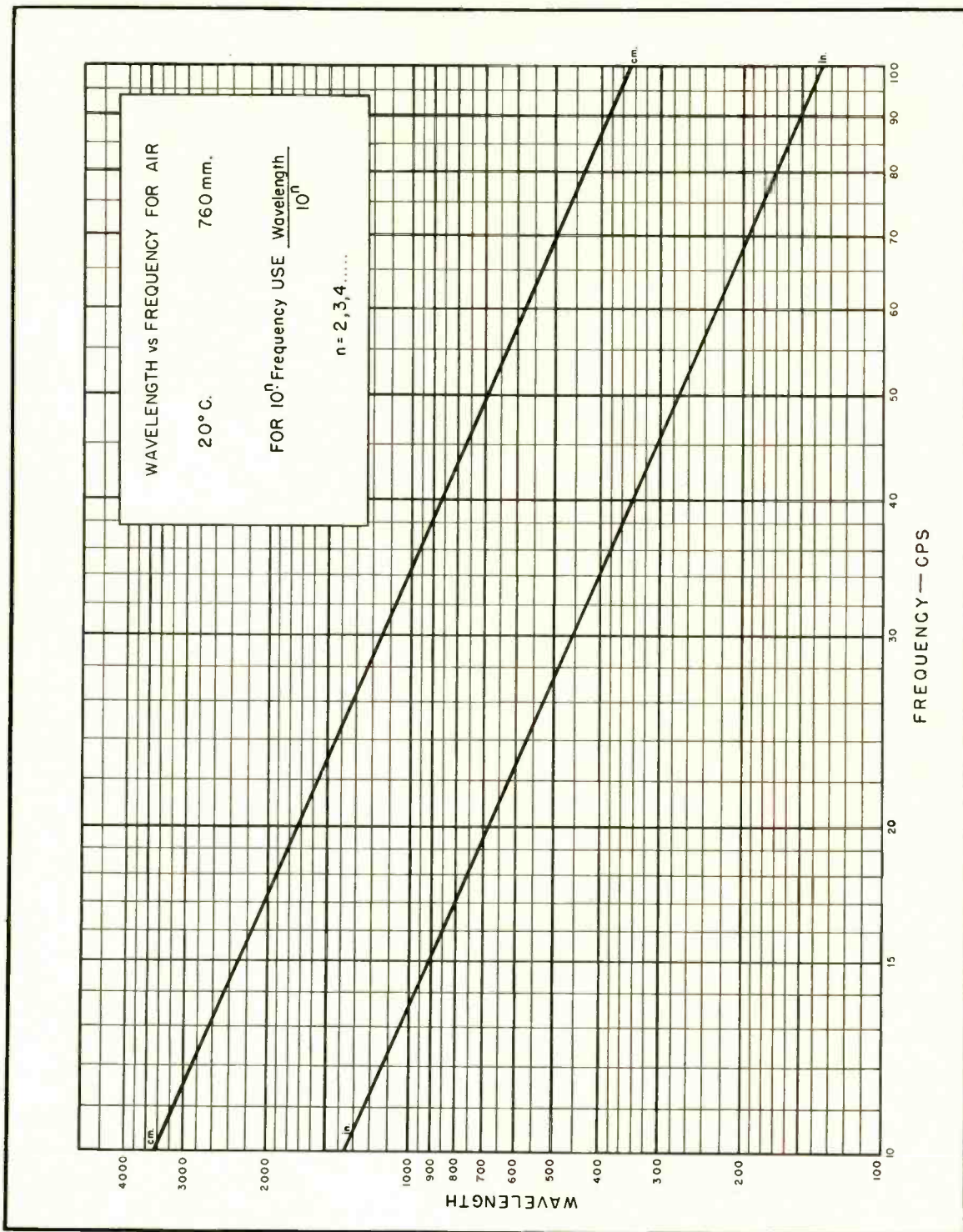

Beauty in Sound

... is the ultimate in natural and precise reproduction obtained by laboratory tested equipment in the ARROW ELECTRONICS Sound Department. Your inspection is always invited.

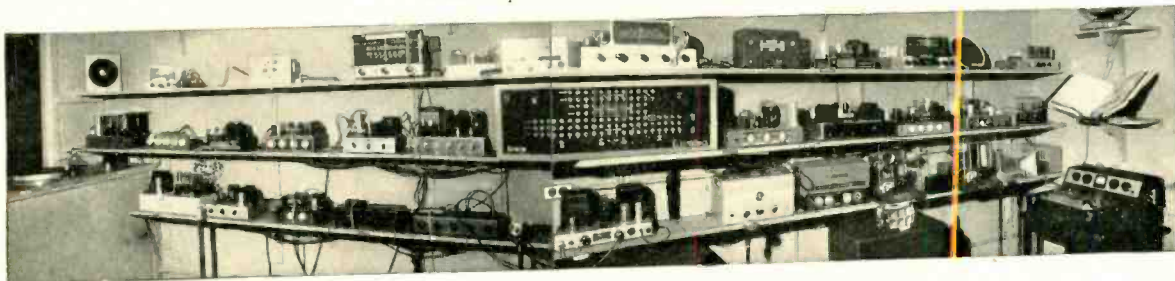

Partial view of our Sound Equipment Studio. Mr. Charles Ray, Manager

THE LOWTHER



DRIVER UNIT

The Lowther Driver Unit, used with the Voigt Horn is the world's most precise sound system. Only those who hear its unsurpassed accoustical efficiency can believe its phenomenal presence effect.

Specifications — Flux Density: 19,500 gauss average over gap area.
 Weight: 19 lbs. (average). Dimensions: 8½" high, 8" wide, 7½" deep.
 Dynamic Impedance: 15 ohms. Frequency Response: 18 to 20,000 cps.

SONAR



RECORDER

The Sonar is a single case tape recorder and playback. Precision made, it is geared for perfect reproduction, rugged wear, and a variety of uses.

Specifications — Power Input: 110-120 v 60 c, 80 w. Input Level: Microphone from —60 D.B. Bridge —10 to ± 10 D.B. based on .006 M.W. ref. Output: Balanced or unbalance 1600 ohm line 0 D.B. or ± 8 DBM to an H Pad. .006 M.W. ref. Frequency Response: 7.5" per sec. 35 to 10,000 c ± 2.75 D.B. with less than 2% total harmonic distortion. Amplifier Response: 20 to 20,000 CPS ± 2 D.B. 0 D.B. level output less than 2% total harmonic distortion.

Playing Time: 7" reel 1,250' of tape, 33 min sgle track 7.5" per sec. 10¼" reel, 2,500', 66 min.

YOU ARE CORDIALLY INVITED

to the ARROW ELECTRONICS display at the Audio Fair, at Hotel New Yorker, October 26-28, 1950. Audio equipment of the very latest technical design will be on display, including the Sonar Tape Recorder and the Lowther-Voigt Reproducer.

We are one of the East's largest distributors of the widest range of electronic parts and components—representing the country's most reputable manufacturers. Trained practical technicians, large warehouse stocks, and overnight delivery in the Metropolitan area, assure you quick, accurate and friendly service.

82 Cortlandt St., New York 7, N. Y.

ARROW  **ELECTRONICS INC** Dlgb 9-4714



Dynamical Analogies

Part II

LEWIS S. GOODFRIEND

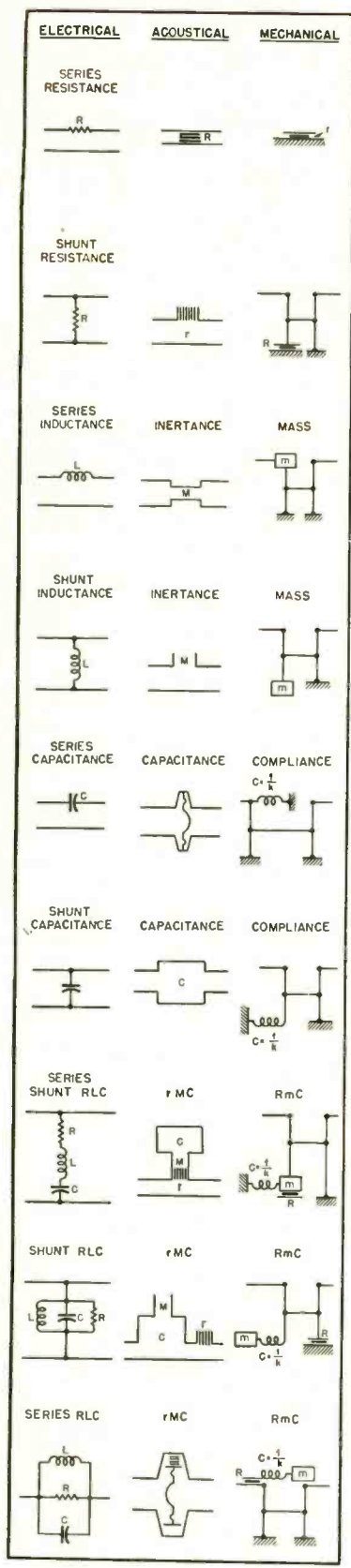

A HANDY CHART of the analogous elements in the three systems (rotational motion cases are not presented because of their scarcity in audio) is presented at the left. In each of the mechanical figures the joints, unless otherwise indicated, are pins. Also in all cases the perturbing forces are considered small, so that it in no case in any classic limit exceeded nor is it ever necessary to consider second order effects.

It should also be noted that there is no exact acoustical analogy for series capacitance, and use is made of a diaphragm of small mass and high stiffness working well below its resonant frequency. The acoustical capacitance of the system is then $C_A = C_M S^2$ which shows that the system is stiffness (k)

controlled since $C_A = \frac{1}{k}$. To compare it with the electrical case it can be seen that a direct current cannot be transmitted by a capacitor nor in this analogy can a change in pressure be transmitted from one side of the diaphragm to the other.

One of the important requisites in the use of the analogies is the use of appropriate units. All electrical units must be expressed as absolute units in which the following relationships hold:

- abohms = $10^9 \times$ ohms
- abvolts = $10^8 \times$ volts
- abamps = $10^{-1} \times$ amps.

The use of different units within any given system is permissible, but it is not practical when working continuously with analogies because it creates confusion.

Loudspeaker Baffles

Figure 3 shows a loudspeaker and several baffles or boxes, together with their electro-mechanical analogies. Examining the circuit of the speaker in the infinite baffle it can be seen that the resonant frequency of the system is determined by the compliance of suspension and the masses of the cone, voice

coil, and airload. This gives the following relation for resonance:

$$X_{MA} + X_{MO} = X_{MS}$$

where $X_{MS} = \frac{1}{\omega C_M}$, reactance due to compliance of mounting of cone.

$X_{MO} = \omega m_C$, reactance of mass of cone and voice coil.

$X_{MA} = \omega m_A$, reactance of air load on cone.

$$m_A = 1.72 \pi \rho R^3, \text{ where } 2R < \lambda$$

For the second case, the enclosed box baffle, there is an additional reactance supplied by the compliance of air in the cabinet, which is in series with the suspension compliance. These compliances are combined in the same manner as series capacitances in an electrical circuit, and thus the total compliance is lower than in the previous case. The expression that must hold for resonance is now:

$$X_{MA} + X_{MO} = X_{MS} + X_{MV}$$

Where

$$X_{MV} = \frac{S_c^2 \rho c^2}{\omega V}$$

is the reactance due to the compliance of the enclosed air volume, cm^3 .

S_c = area of the cone, cm^2 .

ρ = density of air, gm/cm^3 (0.0012)

c = velocity of sound, 34,400 cm/sec .

With this new lower value of compliance, the resonant frequency of the system is raised. However, if a high-quality loudspeaker having a low-resonant-frequency mechanism is used in a baffle or open-backed box of practical size, the response will be curtailed at the low end by the cancellation below the doublet transition. While the same speaker in an enclosed box will have a slightly higher resonant frequency, the overall response is likely to be better. To achieve the same results in a flat baffle

[Continued on page 61]

*We agree that it's hard to believe,
but here it is in the amazing new*

FLEWELLING AUDIO SYSTEM

ONE expert after another has listened to the Flewelling Audio System and summarized its performance as the greatest advance in sound reproduction since the days when headphones and mechanical phonographs were superseded by loudspeakers and electrical pickups.

More than five years were spent on the perfection of this system by the inventor, E. T. Flewelling. He has this to say about it: "I have never made any claims for this system, because audio reproduction is something very personal to each listener. However, some five hundred experts have listened to installations of this design, and all agree that it is the most realistic and enjoyable reproduction they have ever heard."

Here are typical comments (with explanatory notes) made by those who have listened to the Flewelling Audio System, but were not given technical information on its design:

BROADCAST ENGINEER: "You must use 150 watts at the low-frequency end to get such a tremendous effect from the drums!" (Maximum output is less than 5 watts)

AUDIO CONSULTANT: "I'm satisfied that the only speakers in this room are the 8-in. and tweeter speakers set up on plain baffles, but it's impossible for them to deliver the quality that I am hearing!" (There's more to the FAS than meets the eye)

MUSIC CRITIC: "I can feel the vibration from low organ notes, just as I do in the big churches!" (Yes, that's quite true, even down to 32-ft. pipes)

"And I still feel those low notes with the volume down almost to the limit of audibility!" (True again. There's a feeling of vibration in the air, and in the floor, too)

AUDIO ENGINEER: "It sounds to me as if you have invented a new type of speaker with a flat efficiency characteristic down to 27 cycles, or an amplifier which increases enormously in output at the low end. But you tell me that you are using only a pair of 6L6's!" (Only conventional, low-priced speakers are used, and standard audio components)

VIOLINIST: "This is the first time I have heard reproduction when I could distinguish between a violin and a viola!" (That realism, plus a truly amazing presence effect, are characteristic of the FAS)

RADIO MANUFACTURER: "This is luxury performance. Few people can afford such installations!" (The cost is as surprisingly low as quality is high)

ORCHESTRA CONDUCTOR: "I have always tired quickly of listening to radio and phonograph music, but I have listened to this all evening!" (There seems to be no fatigue-factor in the FAS)

CUSTOM DESIGNER: "I can sell any number of jobs like this. How long before I'll be able to get the parts necessary?" (They are available now from any parts jobber.)

Here's how you can find out all the things that those people weren't told when they listened to the FAS:

The details of the Flewelling Audio System will be disclosed in a series of exclusive articles in *FM-TV Magazine*, starting with the October issue. We do not hesitate to promise that you will find Mr. Flewelling's disclosure of his invention, and his discussion of radio-phonograph reproduction the most interesting and intriguing series ever written on any audio subject.

These articles will open up unlimited possibilities for completely new designs for radio-phonograph installations, and endless experiments with tuners, pickups, amplifiers, and speakers. First, however, Mr. Flewelling will present the exact details of the design he is using for demonstration purposes.

Because *FM-TV Magazine* is sold only by subscription, our supply of extra, single copies is very limited. Moreover, the articles on the Flewelling Audio System will run for more than six months. Accordingly, since you will want the complete series, we urge that you enter a year's subscription to start with October. The first issue will be worth the subscription price!

HEAR THIS SYSTEM

It will be demonstrated at our display in Room 638 at the Audio Fair. Bring your own records, and check the quality of reproduction.

GET COMPLETE DATA

Send your subscription order at once, so you will not miss the first article of this series, starting in October.

FM-TV Magazine
Bank Building
Great Barrington, Mass.

Please enter my subscription, starting with the October issue, so that I will have the complete series on the Flewelling Audio System. I enclose:

- \$3.00 for 1 year (12 issues)
 6.00 for 3 years (36 issues)
YOU SAVE \$3.00

Name

Address

FM-TV MAGAZINE

Published by Milton B. Sleeper

Bank Building Great Barrington Massachusetts

RECORD REVUE

EDWARD TATNALL CANBY

Mr. Canby presents a regular program of "New Recordings" on New York City's Own Stations, WNYC (830 kc) and WNYC-FM (93.9 mc), each Sunday at 1:00 P.M.

To the New Subscriber

IT'S BEEN A LONG three and a quarter years of expansion since this magazine and this column began their joint existence, the latter under the somewhat misleading title of RECORD REVUE. We have picked up a lot of subscribers since these early days, and by simple arithmetic, or something, it seems obvious that the same gentry—those who have not read early issues of *Æ*—may now be wondering how a Record Revue ever got to be this way, with a lengthy disquisition at the beginning which only once in a while ties itself directly to records—and sometimes not even any record reviews at all, as happened unavoidably in the July issue.

It's not that we don't intend to cover records as adequately as possible under the present dizzy conditions of runaway LP. (The new experimental policy of more records and shorter reviews goes into effect herewith.) The present Canby department (and the Globus similarly) is in effect two departments—one a Record Revue and the other an article which, since neither the editor nor I have ever been able or willing to figure out a separate name for it, simply gets stuck under the convenient Record Revue head! Confusing for the new subscriber maybe, but after an issue or so you'll get the idea—just overlook RECORD REVUE for Part I and apply it to Part II, which is a review of records.

Preliminary Article

And the why and wherefore of the preliminary article? It seems to have grown more or less out of inner necessity. Inner, as far as this writer is concerned, and inner as far as a good slice of the readership is concerned, too. The rest of this magazine is devoted, as it should be, to competent articles in a technical field by recognized trained technicians in that field. In any other periodical of the sort, in any other area, that would be the end of it, and rightly. This is a technical magazine.

* 279 West 4th Street, New York 14, N. Y.

But the audio field is perhaps unique in that the product—the final product—of all its labors is intelligible sound. Moreover, willy-nilly, a large percentage of that final product is in the form of music, not speech. Audio therefore has the doubtful distinction of existing linked inseparably to an art that in most people's minds is about as far removed from engineering as anything human could be. (I, for one, am ready to deny this violently, but let it ride for the moment . . .) Moreover, audio gets itself involved at every turn with other major fields of endeavor. The listening process, which is the human activity that, in the end, is the final judge of all audio, get us enormously involved in the most advanced psychology; for listening is one of the more subtly difficult things to analyze that the psychologist has in his repertoire. Physiology, too, comes along with audio, for it is the combination of physical reactions and mental ones that makes listening possible . . . but enough said.

Given all of this, and given the intelligent engineer and near-engineer who reads this sheet, given the present writer who happens to be much interested in all of this—a RECORD REVUE in a somewhat wider sense than the title implied was inevitable. Records have a fine way of bringing to a head practically all of the problems that involve audio with its other linked fields. Maybe you can just review records (i.e. talk about the music on them and the performance) and go no further, in any other sort of magazine, but not here! That would be impossible.

Committee of Ph.D.'s

So one thing led to another, as they say . . . and we now come to a final aspect of the present Record Revue-plus-general-discussion. Theoretically, in order to discuss relations between music, psychology, biology *et al*, one should require a super-genius with a Ph.D. in at least each of those fields with (natch) a degree in electronic engi-

[Continued on page 55]

Pops

RUDO S. GLOBUS*

A FEW MONTHS AGO I promised to run a list of pop "classics," based on availability and agreement with conditions already laid down in this column. Something has been going on for the past several weeks which gives priority to this month's column over anything and everything else. Therefore, this month's column will temporarily leave its predestined boundary lines and deal with a situation which affects every possible kind of music.

For the past few years, the music business has been at low ebb. So far, the layman has had no opportunity either to affect or to be affected by the situation. The climatic events of the past six or seven weeks have radically changed the focus of the crisis, and from this point on in, you and I and everybody in any way connected with or interested in music are in the battle. In a certain sense, you and I are responsible for the situation, although it would be blatantly stupid to put more than a partial share on our shoulders.

The situation that led up to the recent catastrophe amounted to something like this: A combination of poor business management and overpopulation resulted in a steady rise in the unemployment of musicians. The death of the dance band after the war, the enormous cut in radio, theatre and night club use of live music, the agonizing suicide of innumerable symphony orchestras throughout the country created a wolf pack of musicians, roaming restlessly through the major centers of American musical activity. Unlike the usual labor shifts that can be expected in other occupational groups, the musician refused to change profession. With the yearly influx of bright-eyed, glamour struck, and naive young musicians into New York, Chicago, and Los Angeles, the situation steadily worsened. In a city with a musical popula-

[Continued on page 51]

* 960 Park Ave., New York 28, N. Y.

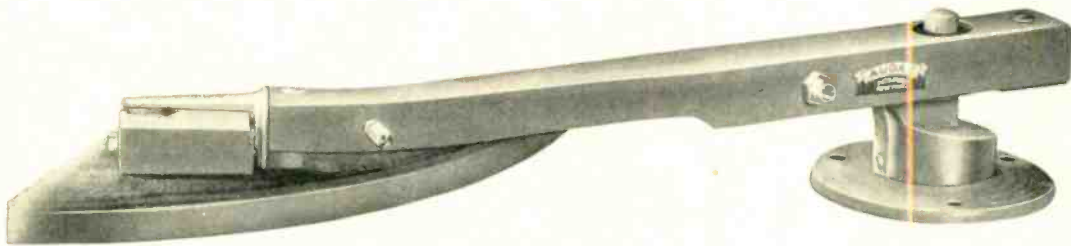

*HANGOVER

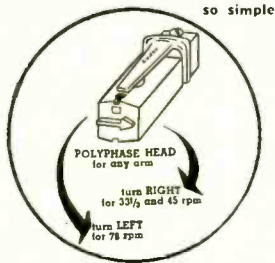

so simple

- One single high quality magnetic unit and same point pressure for all discs—6-8 grams.
- Sapphire styli (or diamond) replaceable individually, as simply as you replaced steel needles.
- Output about 20 m.v.
- Response 20 to over 10,000 cps.
- Needle-talk practically nil.
- Tracking phenomenal.
- High or low impedance.
- Flexible plug-in connectors.
- Available for GARRARD, WEBSTER and other changers. (high-output model for Webster Changers.)

There's an Audax for every purpose . . . including Vertical-Lateral models.

See it and HEAR it at the Audio Fair

* ugly form of distortion

From a letter The first thing that struck me about my L-6 POLYPHASE was the total absence of that strident harshness which has come to be accepted as unavoidable in reproduced music. When played in direct comparison with my , which, I admit, I bought because of the high cycles claimed for it, POLYPHASE is truly a revelation. It is the cleanest, smoothest instrument I have ever heard. If there be many others who, like me, have gained the idea that mere kilocycles and high-fidelity (faithfulness) are synonymous, then the electronic industry is to blame. For me, all that is water over the dam; I am peeved at no one. My L-6 POLYPHASE more than makes up for everything. I look forward to reading your next 'HANGOVER'

Precisely what we've cautioned against! Wide frequency range alone does not produce EAR-QUALITY. Of all the other factors, the most important is reduction of Vibratory-Momentum to near zero. The nearer the vibrating mass to the zero ideal, the less the "HANGOVER" and the finer the finished performance.

The vibrating mass in POLYPHASE is tinier, by far, than in any other pickup hitherto devised. And POLYPHASE costs less.

The Audax ARM . . . SIMPLICITY itself!

- Only 3 parts
- Highest tracking efficiency
- No restraint to stylus travel
- Frontal oscillations nil
- No springs
- No fatigue
- Maintains original point-pressure permanently—regardless of climatic changes
- Unquestionably the simplest and most efficient arm yet devised.

in 12 inch and 16 inch models

and Audax arms cost less

Never before such EAR QUALITY, such FAITHFUL reproduction . . . that is POLYPHASE

but...

ONLY YOU can decide what sounds best and most pleasing to your ears. Therefore see it, HEAR it, and compare it with any re-producer at any price then, you be the judge

— Send for editorial reprint on POLYPHASE principles. —

AUDAK COMPANY

500 Fifth Avenue,

New York 18, N. Y.

"Creators of Fine Electro-acoustical Apparatus for over 30 years"

Introducing a New Series of **TRIAD** Transformers

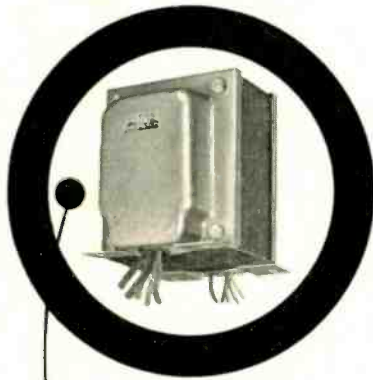

**Especially Designed
for REGULATED
POWER SUPPLIES**

In the design of regulated power supplies, plate voltages, 100 volts or more in excess of those required for normal power supplies, are needed. In addition, the tube filaments are operated at differing potentials, requiring several separate filament windings.

The following new plate and multi-filament transformers, used in connection with standard higher voltage plate transformers and chokes now available, will permit design of a wide range of regulated supplies.

POWER TRANSFORMERS

Type No.	Pri. Volts	Sec. Volts	Fil. No. 1	Fil. No. 2	Fil. No. 3	Fil. No. 4	List Price
R-26A	115	880 720V. C.T. @ 200 Ma.	6.3V. C.T. @ 8A.	6.3V. @ 3A.	6.3V. @ 1A.	5V. @ 3A.	18.50
R-28A	115	1250V. C.T. @ 300 Ma.	6.3V. C.T. @ 8A.	6.3V. @ 3A.	6.3V. @ 3A.	5V. @ 6A.	29.50

FILAMENT TRANSFORMERS

Type No.	Pri. Volts	Fil. No. 1	Fil. No. 2	Fil. No. 3	Fil. No. 4	Fil. No. 5	List Price
F-34A	115	6.3V. C.T. @ 1.75A.	6.3V. @ 1.75A.	6.3V. @ 1.75A.	6.3V. @ 1.75A.		7.25
F-36A	115	6.3V. C.T. @ 3.5A.	6.3V. @ 3.5A.	6.3V. @ 3.5A.	6.3V. @ 3.5A.		10.50
F-38A	115	6.3V. C.T. @ 5A.	6.3V. @ 5A.	6.3V. @ 1A.	5V. C.T. @ 2A.	5V. @ 4A.	12.00

These and other new Triad transformers are described in Bulletin RP-1A, free on request.

Room 530—The Audio Fair
Hotel New Yorker—Oct. 26-
27-28



2254 Sepulveda Blvd.
Los Angeles 64, Calif.

A Controversial Idea from England

P. G. A. H. VOIGT*

AS A RADIO EXPERIMENTER with a brand new degree in 1922, I joined Messrs. J. E. Hough Ltd., then making mouldings for the wireless trade and wishing to go into the wireless business on their own account.

As that firm had long previously taken over the old British Edison Bell Company and were busy making Edison Bell "Winner" and "Velvet Face" gramophone records, readers of *AUDIO ENGINEERING* will understand why I developed a very rapid interest in the recording of master waxes, and why I decided something had better be "done" about the horn recording system then in use.

While it was obvious that any electrically aided recording system would involve the basic items of microphone, amplifier, and cutter, I like, when it is possible, to go beyond the surface of things and consider fundamental factors. So the fundamental question of "what would perfect sound reproduction sound like?" was pondered over.

On enquiry from the experts I found that a "forward" tone was apparently the ideal of the gramophone designer.

Now, having some scientific knowledge, I could not quite understand how a mechanical instrument could be expected to produce a tone which would appear to originate at some point 6 inches, 12 inches, or so in



front of the mouth of the horn, unless this effect were achieved by resonance or some form of forward reflection which would give a focal point there.

The shape of the ordinary gramophone horn certainly did not lend itself to reflections of that kind, and I came regretfully to the conclusion that a forward tone, such as the experts desired, could only be obtained if the air column and (?) the horn were resonating violently at as many frequencies as possible so that the whole of the horn, plus the air near the mouth, was involved in the resonating process and no doubt by building up a sufficient number of resonances, an instrument capable of making a fine loud noise would be produced!

One of the firm's slogans at the time was "It rings out loud and clear," and so we have a clue to the ideas of perfect reproduction of the early '20's.

Now, getting down to fundamentals, a starting point, and a practical example, undistorted sound is that obtained direct by the listener sitting in the actual Concert Hall itself, the ideal case.

If we analyse what he hears, however, we

*Voigt Patents Ltd., London S.E. 26, England.

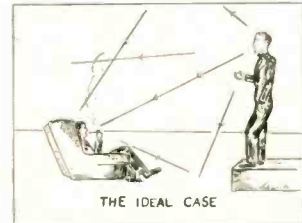

will note that while he hears the direct sound from the Artist, he hears also echoes coming from the ceiling, the back of the Hall, the sides of the Hall, and many multiple reflection echoes which have traversed lengthy paths. Moreover, the echoes reaching his right ear may differ in detail from the echoes reaching his left ear, while with a multiple source of sound there are in addition differences in the arrival times of the sound at his two ears. Any hope of reproducing all these with correct time differences involves two channels and is out of question from the general point of view because of the extra cost.

Fundamentally, therefore, this simple starting point cannot be a guide, and what is required is something which should be as realistic as possible but single channel.

Let us consider now the inescapable conditions of listening in the home. The echo which comes from behind in the Concert Hall may come with a delay corresponding to a sound travel time of 100 feet or more. In the case of the listener at home, however, any echo arriving from the back will be late by the time corresponding to a few feet of travel only. This applies also to the ceiling and any of the other internal reflections which belong to the room in which the listening takes place.

Let us assume now that some lucky citizen is by some magic carried, complete with his listening room, into the Concert Hall and can listen direct through his open window to what is coming in from the stage. If he is suitably placed, he can see the Artist and receive the direct sound wave without any alterations. The first echo reaching him from behind will be a short time echo of the type which belongs to his room. There will be the other usual room echoes, and in addition, there will be long time echoes belonging to the Concert Hall, but they will enter his room by the open window, that is from the same direction as the initial direct sound.

We have thus something, which though not scientifically pure single channel is at least very close to it. Moreover, this particular arrangement preserves at the listener's ears the reverberation of the room in which he is situated and which he cannot eliminate except by using headphones.

It preserves, in a general way, the reverberant effect of the Concert Hall, but deprives the listener of the effect of the spread of the orchestra, i.e., the double channel effect. This is done, however, without introducing distortion due to microphones, valves, transformers, or other non-linear contrivances.

For orchestral works and the like I regard

the above as being the general mental picture to visualise when judging whether sound is well reproduced. In other words, when listening can you close your eyes and imagine yourself situated in the conditions outlined in the foregoing?

Those conditions do not, however, always apply. There is the special case when the Announcer or the Artist is close up to the microphone.

The particular non-electric arrangement corresponding most nearly to that special case, I visualise as occurring when the Announcer or the solo Artist steps up close to the opening in the room above-mentioned and makes his announcement, or plays his instrument for the special benefit of the listener inside the room.

If the distance in the Concert studio between the microphone and the Artist is increased, the effect, to the listener, should be that of the Artist receding further and further from the opening and consequently his voice as heard direct should be accompanied by a bigger and bigger proportion of the reverberation which belongs to the Concert Hall. The reverberation which belongs

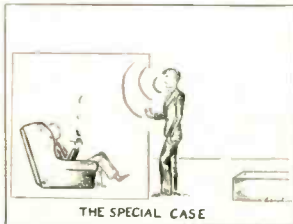

THE SPECIAL CASE

to the listening room is, however, fixed and ordinarily the listener is so accustomed to it that he is not conscious of its independent existence.

From the above I came to the conclusion a very long time ago, that when the loudspeaker and the whole of the rest of the chain is perfect, the listener who listens to such an electro acoustic chain will be hearing sound which will seem identical with what he would expect to hear if his room had been transferred to the Concert Hall and he was listening direct through a suitable opening.

Over the last two decades, with each technical step forward in the practice of sound reproduction, whether it was a widening of the frequency range, a reduction of amplitude distortion or an improvement in transients, the aural result has come nearer to expectations according to my theory above.

I have expounded this "hole in the wall" theory at many lectures over the past twenty years or so. It has caused much argument and even some ridicule, but I believe it to be fundamentally sound.

Should perfect single channel sound re-

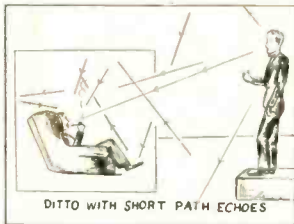

DITTO WITH SHORT PATH ECHOES

production sound as though the loudspeaker had "fallen away" leaving an opening connecting directly to the studio? Or should it sound "as though the orchestra was in the room"?

BROADCAST ENGINEERS



Model 65C

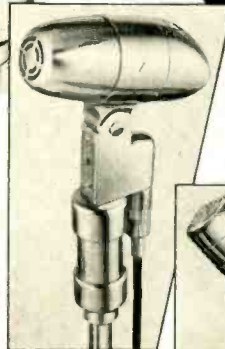

Model 645



Model 635



Model 655



Ultra-Wide-Range
High Fidelity
Laboratory Calibrated



BROADCAST DYNAMICS

The rapidly growing preference for E-V Broadcast Microphones in more and more TV, FM and AM Stations is proof of their fine quality and versatility. They are omnidirectional. The bass end is smooth and flat. The highs are particularly clean. Each is extra rugged. Each has the exclusive E-V Acoustalloy diaphragm. Try one now—Compare it with any mike in your own studios.

Write for new Catalog No. 110 and full facts on how you can studio-test an E-V Mike.

Electro-Voice INC.

400 CARROLL ST., BUCHANAN, MICHIGAN

Export: 13 E. 40th St., N. Y. 16, U.S.A. Cables: Arlab

Microphones, Phono Pickups, Loudspeaker Systems, Self-Tuning TV Boosters

Gray

RESEARCH

FEATURES IDEAL REPRODUCTION

TRANSCRIPTION ARMS

NEW VISCOUS-DAMPED 108-B ARM

For all records—33 1/3, 45 and 78 r.p.m. Radically new suspension development on the viscous damping principle for perfect tracking of records and elimination of tone arm resonances. Instant cartridge change with automatic correct stylus pressure. Solves all transcription problems. Ideal for LP records. For Pickering, new GE (short), old GE (long) cartridges. Write for bulletin. Price, less cartridges, \$56.00 (effective Sept. 1st). Cartridge slides for both GE and Pickering are furnished.



MODEL 106-SP ARM

Designed to meet strictest requirements of modern highly compliant pick-up cartridges. 3 cartridge slides furnished enable GE 1-mil, 2 1/2-mil or 3-mil cartridges or Pickering cartridge to be slipped into position in a jiffy. No tools or solder! Superb reproduction of 33 1/3, 45 or 78 r.p.m. records. Low vertical inertia, precisely adjustable stylus pressure. Write for bulletin. Price, less cartridges, \$45.15



EQUALIZERS

MODEL 603 EQUALIZER

Latest of the universally adopted Gray Equalizers used, with Gray Tone Arms, as standard professional equipment by broadcast stations. High-frequency characteristics obtainable comprise 5 steps — flat, high roll-off, NAB, good records, poor records. For both GE and Pickering cartridges. Price, \$50.70



MODEL 602 EQUALIZER

Has 4 control positions, highly accurate response curves. Price, \$49.50

Write for bulletins on Gray Equalizers.

GRAY RESEARCH and Development Co., Inc.
18 Arbor St., Hartford 1, Conn.

Division of The GRAY MANUFACTURING COMPANY
Originators of the Gray Telephone Pay Station and the Gray Audograph



FAIR EXHIBITORS

[from page 32]

CINEMA ENGINEERING COMPANY 516
1510 W. Verdugo Ave., Burbank, Calif.
Products: Magnetic recorders; equalizers, wave filters, precision resistive devices.

IN ATTENDANCE

Art Davis, Chief Engineer

CLOUGH-BREngle CO. 526
(Gawler-Knoop Co., 1080 N. Broad St., Newark, N. J.)

Products: Sweep-frequency generators, instruments.

IN ATTENDANCE

Charles L. Gawler Walter A. Knoop
H. C. Gawler Allen W. Janes

THE DAVEN COMPANY 616
191 Central Ave., Newark, N. J.

Products: Attenuators; potentiometers; laboratory test equipment such as—transmission measuring sets, electronic voltmeter, output power meter; audio effects filters, RF and Video components, resistors, switches, etc.

IN ATTENDANCE

Lewis Newman, Pres.
J. P. Smith, Chief Engr.
Richard J. Newman, Engineer
E. L. Grayson, Sales Mgr.
C. F. Scott, Engineer
K. K. Garrison, Engineer

ALLEN B. DUMONT LAB., INC. 526
(Gawler-Knoop Co., 1080 N. Broad St., Newark, N. J.)

Products: Cathode ray oscillographs, voltage and time calibrators.

IN ATTENDANCE

Charles L. Gawler Walter A. Knoop
Harry C. Gawler Allen W. Janes

ELECTRONICS OF STATEN ISLAND, N. Y. 537
363 Victory Blvd., Staten Island, N. Y.

Products: Loudspeaker horn enclosures; cabinetry and custom audio devices.

IN ATTENDANCE

Simon Friedland

ELECTRONIC WORKSHOP, INC. 534
351 Bleecker St., New York

Products: Audio amplifiers, oscillators, custom equipment, instruments.

IN ATTENDANCE

H. F. Sterling, Pres.
Alan Sobel, Engineer
Len Sherry, Engineer
Frank Ganci, Gen. Mgr.
Jay Carver, Prod. Mgr.
Jan Syrjala, Technician

ELECTRO-VOICE, INC. 629
Buchanan, Mich.

Products: Microphones, pickups, cartridges, loudspeakers, loudspeaker cabinets and components, TV boosters.

IN ATTENDANCE

A. R. Kahn, Pres.
H. T. Souther, Mgr. Spkr. Div.
W. F. Soules, Sales Mgr.
J. E. Willson, Eastern Sales Mgr.

FAIRCHILD RECORDING EQUIP. CORP. 653

154th St. & 7th Ave. Whitestone, N. Y.
Products: Tape recorders and equipment.

IN ATTENDANCE

Jay H. Quinn Leon A. Wortman

FM & TV MAGAZINE 539

Great Barrington, Mass.
Products: FM & TV Magazines; audio equipment for demonstration.

IN ATTENDANCE

Milton B. Sleeper, *Publisher*
 Charles Fowler, *Bus. Mgr.*
 Ray Allison, *Assoc. Editor*

FISHER RADIO SALES CO., INC. 529

41 E. 47th St., New York
Products: Concertone magnetic tape recorders.

IN ATTENDANCE

Avery R. Fisher Emanuel Berlant

GATES RADIO COMPANY 607

Quincy, Illinois
Products: Broadcast station, speech input equipment and accessories.

IN ATTENDANCE

Fred O. Grinwood, *Vice Pres.*
 Norbert Yochem, *Chief Audio Engr.*
 Owen J. McKeay, *Eastern Sales Mgr.*
 L. Cerrone, *N. Y. and New England Sales Engr.*

GAWLOR-KNOOP COMPANY 526

(Manufacturers' Representatives)
 1060 Broad St., Newark, N. J.
Representing: Allen B. DuMont Laboratories;
 Ballantine Laboratories; Clough Brengle Co.
Products: Audiomatic sweep generator; audio oscillator; electronic voltmeter; cathode-ray oscillographs.

IN ATTENDANCE

Harry C. Gawler, *Partner*
 Walter A. Knoop, *Partner*
 Charles L. Gawler, *Partner*
 Allyn W. James

GENERAL ELECTRIC COMPANY 532

Electronics Park, Syracuse, N. Y.
Products: Speakers, standard and professional pickup cartridges, styl, tone arms, pre-amplifiers, and phono-tuner kit.

IN ATTENDANCE

E. A. Malling, *Sales Mgr., Component parts*
 T. J. Nicholson, *Asst. to Sales Mgr.*
 Mark Woodworth, *Comm. Engineer*

HARRISON RADIO CORPORATION 608

225 Greenwich St., New York
Products: Assorted audio equipment.

IN ATTENDANCE

Bil Harrison Ted Suito

HARVEY RADIO COMPANY, INC. 631

103 W. 43rd St., New York
Products: Assorted audio equipment

IN ATTENDANCE

Harvey E. Sampson, *Pres.*
 Sam Findling, *Store Mgr.*
 Roy Neusch, *Sales Mgr.*
 George Zarrin, *Asst. Store Mgr.*

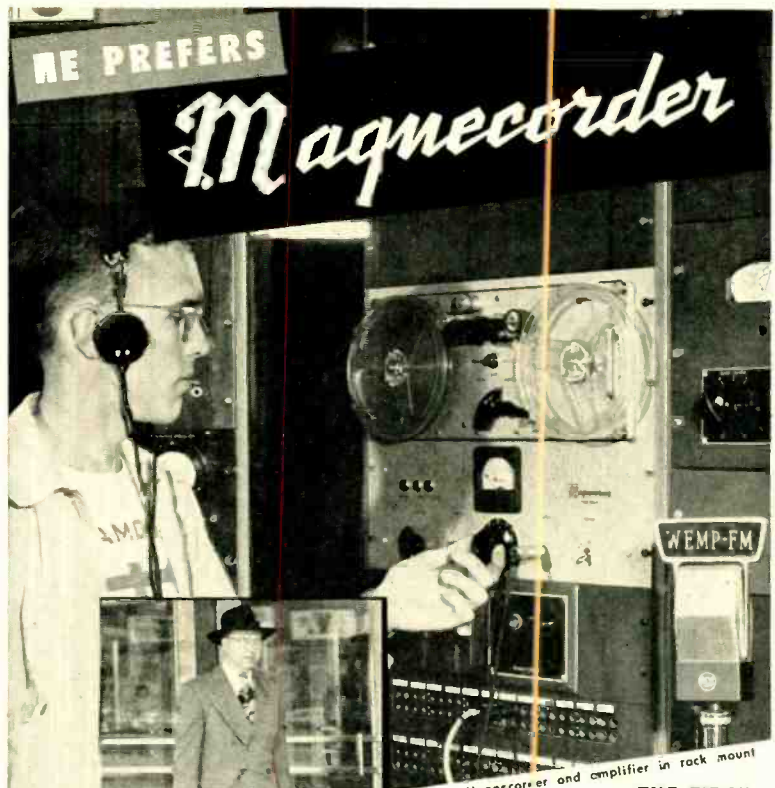

Magnecorders are portable, perfect for remotes.

THE FIRST CHOICE OF RADIO ENGINEERS

HIGH FIDELITY, LOW COST

Only Magnecorder offers you such high fidelity at such low cost. Magnecorder frequency response: 20-15 kc \pm 2 db. Signal-noise ratio: 50 db. Harmonic distortion less than 2%. Meets N.A.B. standards. More radio engineers use Magnecorders than all other professional tape recorders combined!

GREATEST FLEXIBILITY

Mount a Magnecorder in a rack or console cabinet for delayed studio or network shows. Slip it into its really portable cases for remotes.

Add to your Magnecorder equipment as you need it—combine and carry Magnecorders to suit every purpose.

MORE FEATURES

Your Magnecorder, new or old, now can have 3 heads (separate erase, record, and playback) to permit monitoring from tape. Three speeds (15"-7 1/2"-3 3/4" — up to an hour on a 7" reel) available on both PT6 and PT63 equipment. Dual track heads also available if desired.

MAGNECORDER

For every purpose . . . every purse!



PT6 SERIES
 Most widely used professional tape recorder in the world.



PT63 SERIES
 Three heads to erase, record, and monitor from the tape.



PT7 SERIES
 A complete console for only \$950.00. Outstanding features and flexibility. Models for portable or rack mount also available.

Write for NEW CATALOG

MAGNECORP, Inc., Dept. A 10
 360 N. Michigan Ave., Chicago 1, Ill.
 Send me latest catalog of Magnecorder equipment

Name.....
 Company.....
 Address.....
 City..... Zone..... State.....

HUDSON RADIO & TELEVISION CORP. 635
212 Fulton St., New York
Products: Audio, AM and FM equipment and components.

IN ATTENDANCE

Sol Baxt, *Pres.* L. Klein, *Sales Mgr.*
C. Carlson A. Straus
L. Friedman E. Samuel

LANGEVIN MANUFACTURING CORP. 538
37 W. 65th St., New York
Products: Microphone and line amplifiers, tube and selenium power supplies, transformers, fixed-frequency receivers.

IN ATTENDANCE

D. S. Morgan, *Pres.*
Paul Zolwiler, *Sales Service Supervisor*
F. K. Hankinson, *Transformer Sales Mgr.*
David Fidelman, *Project Engr.*

G. V. Rosenquist, *Gen. Mgr.*
John Harris, *Chief Engr.*
John Guenther, *Project Engr.*

JAMES B. LANSING SOUND, INC. 601-605-606
2139 Fletcher Drive., Los Angeles, Calif.
Products: Speakers of quality.

IN ATTENDANCE

Leonard Larson

LEONARD RADIO, INC. 536
89 Cortlandt St., New York
Products: Miscellaneous audio items; speakers, amplifiers, microphones, and tuners.

IN ATTENDANCE

Sidney Schugar, *Mgr.*
Joseph Chislo, *Engr.*
Arthur Priest, *Adv. Mgr.*
Ellis Rosen, *Salesman*

MAGNECORD, INC. 604-605-606
360 N. Michigan Ave., Chicago, Ill.
Products: Magnetic recording and reproducing equipment, amplifiers, and speakers.

IN ATTENDANCE

C. G. Barker, *Vice Pres.*

McINTOSH ENGINEERING LABORATORY 604-605-606
Silver Spring, Maryland
Products: Amplifiers.

IN ATTENDANCE

Frank McIntosh

MEASUREMENTS CORPORATION 527
Boonton, N. J.
Products: Test equipment.

IN ATTENDANCE

H. W. Houck, *Pres.*
Jerry B. Minter, *Chief Engr.*
Edgar M. Weed, *Adv. Mgr.*
Wm. Albert, *Dir. of Purchases*
John M. Van Geuren, *Chief Res. Engr.*
N. C. Doland, *Sales Mgr.*
John H. Redington, *Sales Engr.*

MIDWAY RADIO AND TELEVISION CORP. 609
60 W. 45th St., New York
Products: High-Fidelity sound equipment.

IN ATTENDANCE

Paul Berke, *Pres.*
Harold Kahn, *Sec'y.*
Sol Sternin, *Treasurer*
Harry Diamond, *Vice Pres.*
Ily Rosenberg, *Adv. Mgr.*

MILO RADIO & ELECTRONICS CORP. 641
200 Greenwich St., New York
Products: Amplifiers, pickups, speakers, microphones, tape recorders, and assorted audio equipment.

IN ATTENDANCE

Milton Putterman, *Pres.*
Leo Klein, *Gen. Mgr.*
Imsil Guerra, *Salesman*
Al Pantue, *Mgr. Sound Dept.*
Mal Tepper, *Store Mgr.*
Mattie Williams, *Pur. Mgr.*

PANORAMIC RADIO PRODUCTS, INC. 626
10 S. Second Ave., Mt. Vernon, New York
Products: Model AP-1 Panoramic Sonic Analyzer, Model SB-7 Panoramic Ultrasonic Analyzer, Panoramic Sonic Response Indicator.

IN ATTENDANCE

Bernard Schlessel, *Sales Mgr.*
Robert Shologan, *Engr.*
Robert Augustine, *Engr.*

PEERLESS ELECTRICAL PRODUCTS DIV. 618-619
(Altec Lansing Corp.)

161 Sixth Ave., New York
Products: Power transformers; filter chokes; input, interstage, output, modulation, and replacement transformers. "A transformer for every audio application."

IN ATTENDANCE

H. S. Morris Dave Sonkin
Mel Sprinkle Marty Wolf

THE PERMOFLUX CORPORATION 610
4900 W. Grand Ave., Chicago, Ill.
Products: Loudspeakers and headsets.
R. S. Fenton, *Sales Mgr.*
L. M. Heineman
Mike Del Camp, *Asst. to Sales Mgr.*
Rex L. Munger, *Jobber Sales Mgr.*

NEW LABORATORY INSTRUMENTS
custom-designed for AUDIO SPECIALISTS!

Negligible loading with the BRIDGER

In bridging measuring instruments across high-Z circuits, lowest possible loading is vital. Model 100's improved cathode follower and special double-shielded cable reduce cable capacitance and circuit leakage to the infinitesimal. Input Z: 100 megs, 6 mmf, with 3-ft cable. Output Z: 200 ohms. Output/input voltage: 0.99. Price \$72.50.

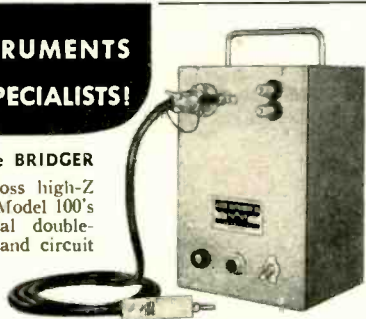

Easier, faster, low cost Distortion Testing with INTERMODULATION SET

For the first time—here's a quality IM set at a truly low cost! With Model 162, and your audio oscillator and oscilloscope, you read per cent of IM in any pickup, amplifier or system **directly on your scope image**—in just seconds. Complete with graphic instructions for adjusting equipment for best performance. Price \$88.50.



Model 121 LOGGER
Logarithmic VM with 50 db linear scale. Output may feed direct-writing recorder (via suitable amplifier) for acoustical reverberation tests. Input Z: 50,000 ohms. Output Z: 1000 ohms.



Model 140 DISC-NOISE METER
Overload-proof amplifier VM for quality control of lacquers, phono records, transcriptions. New stable logarithmic element. 20 db linear scale. Minimum reading 75 db below 7 cm/sec. velocity with pickup cartridge supplied.



MINIATURE PREAMPLIFIERS for 640AA Condenser Microphone

Model 12: High gain. Operates VTVM directly at normal room sound levels. Output: -40 dbm, 1 dyne/cm². Output Z: 250 ohms, balanced.

Model 14: Medium gain. For general broadcast and recording. Operates VTVM directly at receiver testing pressures. Output: -55 dbm, 1 dyne/cm². Output Z: 250 ohms, balanced.

Audio INSTRUMENT COMPANY
Dept. T 133 WEST 14th St. NEW YORK 11, N. Y.

WRITE NOW FOR CATALOG A.
See us at the AUDIO FAIR

PICKERING & COMPANY, INC. 624-625
Oceanside, N. Y.

Products: Pickup cartridges, arms, equalizers, and associated pre-amplifiers and amplifying components; loudspeakers; intermodulation distortion measuring devices.

IN ATTENDANCE

Norman C. Pickering, *Pres.*
George Petelin, *Sales Dept.*
Walter O. Stanton, *Vice Pres.*

PRESTO RECORDING CORPORATION 612

P.O. Box 500, Luckensack, N. J.
Products: Disc and tape recording equipment; disc and tape transcription equipment; amplifiers; blank recording discs.

IN ATTENDANCE

George J. Saliba, *Pres.*
Thomas B. Aldrich, *Sales Mgr.*
Irv. Rosenblatt, *Engr.*
M. M. Gruber, *Sec'y.*
John Strampfer, *Prod. Mgr.*
Fred Jurysz, *Engr.*

RADIO CORPORATION OF AMERICA 632-633-634

RCA-VICTOR DIVISION

Camden, N. J.
Harrison, N. J.
Products: Magnetic tape and film recording equipment, microphones, amplifiers, loudspeakers, component parts.

IN ATTENDANCE

J. P. Taylor A. K. Ward
C. M. Lewis R. A. Tenre
M. A. Tralner W. L. Tesch
A. C. Lindquist T. A. DeStimone
W. O. Hadlock W. L. Lawrence
L. T. Lalutka L. LeKashman

RADIO MUSIC CORPORATION 533

84 S. Water St., Port Chester, N. Y.
Products: Audio equipment design, development, and manufacturing.

IN ATTENDANCE

Lionel Cornwell Donald Heyll
J. F. Rigby

RADIO & TELEVISION NEWS 533

306 Madison Ave., New York
185 N. Wabash Ave., Chicago, Ill.
Products: Magazines.

IN ATTENDANCE

Oliver Reid Murray Goldman
Leonard R. Osten Jerome Jacobs
Harrie K. Richardson

RANGERTONE, INC. 621

73 Winthrop St., Newark, N. J.
Products: Multichannel tape recorders, professional tape recorders, synchronized tape recorders.

IN ATTENDANCE

Sam L. Ackerman R. H. Itanger
F. Whitelrouse P. Brubaker
A. V. Colabella Robert Walker

SATURDAY REVIEW OF LITERATURE 539

25 West 45th St., N. Y.
Products: "America's No. 1 Recording Section"

IN ATTENDANCE

Jay Woodruff, *Advt. Mgr. Rec. Sec.*
Irving Kolodin, *Editor*
Roland Gellati, *Assoc. Editor*
Edward T. Canby, *New Recordings*
Bert Garmise, *Dial of Recordings*

HARVEY presents



THE NEW REK-O-KUT RECITALIST

Three-speed reproduction unit in portable case . . . with the exclusive Polyphoric Selector that maintains tonal balance and equalization for the particular selection being played. Plays up to 16" transcriptions, standard pressings and micro-grooves, both American and foreign. Dual stylus cartridge in 6" arm; 8" PM speaker; machined aluminum turntable; Neoprene idlers; heavy duty motor; power output 10 watts; inputs for mike, radio and xtal pickup . . . \$199.95



REK-O-KUT VARI-CON DRIVE TURNTABLE

Newest thing out . . . plays at any speed from 25 to 100 RPM without "WOW". Constantly variable, reproducible speed settings, accurately calibrated for 33 1/3, 45 and 78. Play your records at their best sounding speed . . . set tempo just as you want it. 12" precision machined cast turntable; constant speed AC motor; noise level 30 db down.



Model CVS-12—Chassis, motor and turntable . . . \$ 84.95

Model CVS-12P—In portable case with 16" pickup . . . \$124.95

OTHER REK-O-KUT TABLES

MODEL	SPEED	SPECIFICATIONS	NET PRICE
T-12H	78-33 1/3	Noise Level: -50 db Motor: Hysteresis Synchronous Chassis: Aluminum casting, cross ribbed, flush mount Turntable: Aluminum, lathe turned	\$119.95
T-103A		45 rpm idler with record adapter interchangeable with 33 1/3	6.00
T-43H	45-33 1/3	same as for model T-12H	\$119.95
T-104		78 rpm idler, interchangeable with 45 rpm	5.50



NEW RCA 15" DUO-CONE SPEAKER

High fidelity speaker with "built-in crossover," no network needed, minimum crossover interference. Can handle up to 25 watts power. Has dual voice coils driving dual cones, with crossover frequency at about 2000 cycles, at which point the duo-cones vibrate as a single unit. Alnico V magnet weighs 2 pounds, speaker 15 pounds . . . \$49.50

WESTERN ELECTRIC SPEAKERS

Here's another good buy from Harvey's. Genuine Western Electric speakers at a new low price, every one brand new in factory sealed cartons. These are the genuine article from our regular stock.

12" - 728-B . . . \$31.20 8" - 755-A . . . \$22.35

WILLIAMSON HR-15 AMPLIFIER KIT

Kit is complete with tubes, punched chassis, prewired resistor board, sockets, genuine Partridge output transformer, and all necessary parts, \$75.00 net.

AUDAK POLYPHASE PICKUPS

Wide range performance on standard or micro-groove records. The L-6 head is of studio quality with many exclusive features. Models for studio and station use, for home changers and home use. Vertical-lateral models also.

L-6 head for studio . . . \$20.70 12" Audak arm . . . \$13.80
L-6G for Garrard . . . 23.40
L-6G for Webster . . . 23.40 16" arm . . . 19.80
R-2 for lateral records . . . 14.70 16" studio arm . . . 39.00

VISIT THE AUDIO-TORIUM

Come in and visit our new sound department . . . all these items and many more on working display at all times.

Telephone: **3-ORC** LOnghack 3-1800



103 West 43rd St., New York 18 N. Y.

NOTE: In view of the rapidly changing market conditions, all prices shown are subject to change without notice and are Net, F.O.B., N.Y.C.

If you are



... a Manufacturer
 ... a Design Engineer
 ... a Broadcast Station
 Owner

producing, designing, or using audio devices and equipment—here is a coordinated group of test instruments which enable you to check fidelity, noise, distortion, overall performance, and meet FCC Compliance Tests with the least amount of time, trouble, and expense.

B&W

**DISTORTION METER
 MODEL 400 \$140**

For fundamentals from 30 to 15,000 cycles measuring harmonics to 45,000 cycles; as a volt and db meter from 30 to 45,000 cycles. Min. input for noise and distortion measurements .3 volts. Calibration: distortion measurements ± 5 db, voltage measurements $\pm 5\%$ of full scale at 1000 cycles.



**AUDIO OSCILLATOR
 MODEL 200 \$115**

Provides a low distortion source of audio frequencies between 30 and 30,000 cycles. Self-contained power supply. Calibration accuracy $\pm 3\%$ of scale reading. Stability 1% or better. Frequency output flat within 1 db, 30 to 15,000 cycles.



**SINE WAVE CLIPPER
 MODEL 250 \$10**

Speeds accurate analysis of audio circuits by providing a test signal for examining transient and frequency response . . . at a fraction of the cost of a square wave generator. Designed to be driven by an audio oscillator.



SEE YOUR DEALER OR WRITE TODAY
 FOR COVERING LITERATURE, DEPT. AE-100.

BARKER & WILLIAMSON, Inc.

237 Fairfield Avenue

Upper Darby, Penna.

HERMON HOSMER SCOTT, INC. 528

385 Putnam Ave., Cambridge, Mass.

Products: Dynatural noise suppressors, high-fidelity audio amplifiers, sound and vibration measuring equipment, electronic and acoustical laboratory apparatus.

IN ATTENDANCE

H. H. Scott, *Pres.*

E. G. Dyett, Jr., *Prod. Mgr.*

V. H. Pomfer, *Sales Mgr.*

MARK SIMPSON MFG. CO., INC. 603

32-28 49th St., Long Island City, N. Y.

Products: Magnetic tape recorders, transcription players, high-fidelity amplifiers, and sound systems.

IN ATTENDANCE

Mark Simpson, *Pres.*

G. L. Werner, *Chief Engr.*

Henry Berlin, *Sales Engr.*

R. Asen

Miriam Simpson, *Vice Pres.*

David Libsohn, *Asst. Sales Mgr.*

S. Nachilgall, *Exec. Engr.*

Bill Wolfner

REEVES SOUNDRAFT CORP. 602

35-54 36th St., Long Island City, N. Y.

Products: Blank recording discs, magnetic recording tape, recording accessories.

IN ATTENDANCE

A. C. Travis, *Vice Pres.*

John Travis, *Sales Engr.*

Don. E. Ward, *Sales Mgr.*

David Ruark, *Adv. Mgr.*

REK-O-KUT COMPANY, INC. 636-637

33-01 Queens Blvd., Long Island City, N. Y.

Products: Rek-O-Kut recording and equipment, motors, turntables, and equipment.

IN ATTENDANCE

George Silber, *Pres.*

H. Siegal, *Asst. Sales Mgr.*

Sidney Simonson, *Vice Pres.*

Frank Scannell, *Sound Engr.*

SOMERSET LABORATORIES, INC. 627

1701 Palisades Ave., Union City, N. J.

Products: Amplifiers and noise suppressors.

IN ATTENDANCE

Carl E. Ring, *Pres.*

Frank Guenther, *Engr.*

Edw. Van Rosser, *Assistant*

Sidney Colerrian, *Chief Engr.*

Helen Connelly, *Sec'y.*

SONAR RADIO CORPORATION 652

50 Myrtle Ave., Brooklyn, N. Y.

Products: Tape recorders and allied audio equipment.

IN ATTENDANCE

Edw. A. Babkes, *Pres.*

Syd. D. Yarm, *Mech. Engr.*

Jack Babkes, *Chief Engr.*

Anthony Spam, *Asst. Engr.*

STEPHENS MANUFACTURING CORP. 620

8538 Warner Dr., Culver City, Calif.

Product: Loudspeakers and microphones.

IN ATTENDANCE

Robert L. Stephens, *Pres.*

Sam S. Egert, *Representative*

Michael Scott, *Representative*

Norman Simons, *Export Mgr.*

Jack Fields, *Representative*

SUN RADIO & ELECTRONICS CO., INC. 601
124 Dunne St., New York
Products: Assorted audio equipment, speakers, amplifiers, tone arms, pickups, kits, etc.

IN ATTENDANCE

Sam Gerard Irving Greene
Sandy Herman

TECH LABORATORIES, INC. 647
Bergan & Edsall Blvds., Palisades Park, N. J.
Products: Attenuators, potentiometers, reverbation generator, monitoring amplifiers, etc.

IN ATTENDANCE

M. Bjorndahl, *Pres.*
G. Van Baaren, *Sales Mgr.*
G. Harris
K. Meri
E. Bjorndahl, *Vice Pres.*
A. L. Budd
W. Richards

TERMINAL RADIO CORPORATION 622
85 Cortlandt St., New York
Products: Audio equipment and components.

IN ATTENDANCE

Robert Corey Wm. Filler
Jack Simon

THE TETRAD CORPORATION 623
60 N. Broadway, Yonkers, N. Y.
Products: Diamond phonograph styl.

IN ATTENDANCE

Morton V. Marcus, *Pres.*
Emanuel J. Marcus, *Sec'y.*
Howard M. Weinberger, *Vice Pres.*

TRIAD TRANSFORMER MFG. CO. 530
2254 Sepulveda Blvd., Los Angeles, Calif.
Products: Transformers, reactors, hermetic terminals.

IN ATTENDANCE

L. W. Howard, *Partner & Chief Engr.*
Ernest Clover, *Geophysical Engr.*

UNITED TRANSFORMER CO. 638
150 Varick St., New York
Products: Transformers, filters, and amplifier kits.

IN ATTENDANCE

S. L. Baraf, *Vice Pres.*
Bob. Mitchell, *Engr.*
S. Rubin, *Engr.*
Ben Miller, *Sales Mgr.*
Joe Barecca, *Engr.*
S. Manville, *Engr.*

UNIVERSITY LOUDSPEAKERS, INC. 611
80 S. Kensico Ave., White Plains, N. J.
Products: Loudspeakers.

IN ATTENDANCE

Irving Golin, *Pres.*
Lawrence J. Epstein, *Sales Mgr.*

UNIVERSITY LOUDSPEAKERS, INC. 611
80 S. Kensico Ave., White Plains, N. J.
Products: Commercial, industrial, and high-fidelity loudspeakers and accessories.

IN ATTENDANCE

S. J. White, *Chief Engr.*
A. Cohen, *Project Engr.*
Arthur Blumenfeld, *Prod. Supt.*
Sidney Levy, *Dir. of Eng.*
Vincent Carey, *Sales*
Seymour Blumenfeld, *Sales*
Edward Reese, *Engr.*

"Have some pudding?"



You have to try it before you can appreciate the taste—until then—you can't prove it's good.

"The proof of the pudding is in the eating" is a time-worn adage—and, if it's been around so long, there's a chance that there is a lot of common sense packed in those few words.

We don't mean to suggest that Soundcraft discs taste good. What we would like to get over is that, until you try Soundcraft products, we can talk our heads off about how good they are.

Use Soundcraft products in your operations—you'll prove for yourself that all Soundcraft recording media will guarantee you the one thing they are designed for—the best possible performance in recording sound.



SOUNDCRAFT'S ONLY CLAIM IS ITS PROOF OF PERFORMANCE

REEVES — "20 YEARS WITH SOUND RECORDING MEDIA."

REEVES Soundcraft CORP.

35-54 36th STREET, LONG ISLAND CITY 6, N. Y.

EXPORT—REEVES EQUIPMENT CORP. • 10 E. 52ND, N. Y. 22, N. Y.

developed into an inexpensive but quantitative method by this study.

The widely held opinion that there is a firm relationship between harmonic and intermodulation distortions is shown to be entirely wrong. The only way to determine the intermodulation distortion of a unit is to measure it directly.

The use of oscilloscope patterns for adjusting amplifiers and other components in factory test and laboratory will also be discussed, with a number of illustrations.

3: 45 p.m.

LOUDSPEAKER DAMPING

ALBERT PREISMAN, *Capital Radio Engineering Institute*

Adequate damping of the motion of a loudspeaker cone is shown to be one of the principal considerations in the design and application of these units. The effects of horns and of various types of baffles are shown, and it is proved that proper damping of a speaker by means of the correct design of its electrical characteristics will provide more satisfactory operation with an increase in efficiency, whereas mechanical damping decreases efficiency. Practical methods of measuring mechanical impedance of a loudspeaker are described, together with means for adjusting the electrical characteristics under which the loudspeaker operates.

4: 20 p.m.

REPORT OF AES STANDARDS COMMITTEE ON PLAYBACK CHARACTERISTICS

S. EDWARD SORESENSEN, *Columbia Recording Corp.*

SATURDAY, OCTOBER 28, 1950

9: 30 a.m. to 12: 00 Noon

Magnetic Recording Session
Grand Ballroom

PRICE FISH, *Chairman*

MULTI-CHANNEL MAGNETIC RECORDING

PAUL M. BRUBAKER, *Rangertone, Inc.*

Discussion on the problem of adjacent channel interference on low frequencies and use of amplitude modulation as a solution to the problem. This allows for a four-channel high-fidelity recorder using $\frac{1}{4}$ " tape playing four hours at $7\frac{1}{2}$ " /sec. and usable down to 45 cps or lower depending upon application. Utilizing amplitude modulation techniques, a 12-channel telemetering system is possible using $\frac{1}{4}$ " tape. All of the possible sources of error are minimized by negative feedback or a.v.c. allowing for an over-all system accuracy of plus or minus 3 per cent.

10: 05 a.m.

A SOLUTION TO THE MAGNETIC TAPE TIMING PROBLEM

D. R. ANDREWS, *Radio Corporation of America*

The dimensional instability of base materials used in the manufacture of magnetic recording tape makes it imperative that some means of control be employed if careful timing of recorded programs is to be maintained. Various systems which may overcome this handicap are briefly described.

One specific system is described in detail. It provides very accurate timing over long time-periods. A signal is generated from optical markings on the reverse of the tape. This signal is scanned and compared with a standard frequency for speed correction. Means is provided for using either marked or standard tape interchangeably.

10: 40 a.m.

A NEW EXPLANATION OF THE ACTION OF A.C. BIAS IN MAGNETIC RECORDING

W. W. WETZEL, B. J. MURPHEY, and R. HERR, *Minnesota Mining & Manufacturing Co.*

Although the beneficial effects of a.c. bias on

WE MAKE LOUDSPEAKERS ...not apologies!

If you could see the way we make RACON Paging and Talk-Back Speakers—as so many sound men do, at our invitation—you'd know why they return for more RACON Speakers . . . why they don't come back with complaints—or we with excuses.

POWER Only RACON Paging Speakers—no other—have continuous power capacities of 20 watts (peak 35 watts) and 10 watts (peak 15 watts). The proof of their ability to take punishment is that they are guaranteed for 18 months.
Does your loudspeaker line have this?

DESIGN Every part of a RACON Paging Speaker is exponentially flared. Why? Because an exponential flare is the most efficient method of coupling a diaphragm to the moving air. More costly for us, of course—but it results in greater sound output and better low frequency response.
Does your loudspeaker line have this?

CONSTRUCTION The response of a RACON Paging Speaker is smooth, clean and free from vibration and resonant peaks. This is primarily due to the fact that, in place of the usual thin tin tone arm, RACON uses a $\frac{1}{4}$ " wall aluminum casting for the tone arm.
Does your loudspeaker line have this?

IMPEDANCE Every RACON Paging Speaker is available in 8, 15 or 45 ohms—at the same price.
Does your loudspeaker line have this?

MOUNTING RACON mounting brackets are designed for life. Instead of zinc or thin sheet metal brackets which give way under vibration, only husky rib-reinforced aluminum castings are employed.
Does your loudspeaker line have this?

VOICE COIL Aluminum-wound voice coils are usually associated with the most expensive types of loudspeakers. Yet in RACON Paging Speakers they are standard—to provide greater efficiency and better response characteristics.
Does your loudspeaker line have this?

PRICE The price tag on RACON Paging Speakers might be a little higher. Why? Because of the extra care and quality we put into every speaker. The price reflects honest engineering, skilled craftsmanship and top performance . . . these are constant, and so are the prices. We like to say, "RACON Paging Speakers are always for sale—never on sale."
Does your loudspeaker line have this?

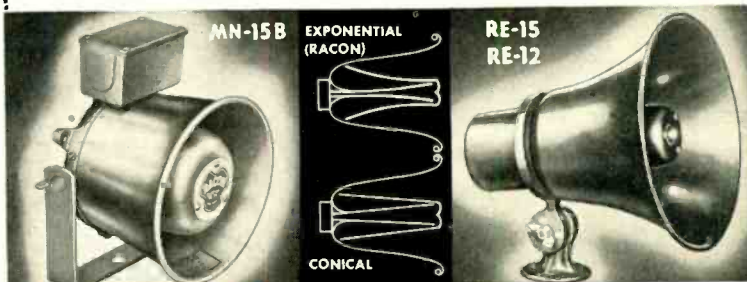

Model RE-15 (20 watts; 8, 15 or 45 ohms)	\$34.00
Model MN-15B (20 watts; 8, 15 or 45 ohms)	\$34.00
Model RE-12 (10 watts; 8, 15 or 45 ohms)	\$26.00

The proof of all these facts is in putting RACON Paging Speakers to work for yourself. Connect one to an amplifier and give it the roughest, toughest test you want. You'll be coming back—not to complain—but for more.

ACOUSTICAL  EXCELLENCE

SOUND EQUIPMENT MANUFACTURERS **Racon Electric Co., inc.** 52 East 19 St. New York 3, N. Y.

In Canada: Dominion Sound Equipments Limited, Montreal, Que.

Here's why those in the know

-demand

CANNON PLUGS

Ribbed for excellent grip.

Boss prevents movement.

With special anodized or lacquered finishes, threads are masked to maintain shielding or bonding.

Interchangeable pin and socket inserts... fit all Cannon shells of same diameter.

No section of plug exceeds end bell diameter.

Contacts, precision-machined from solid bar stock, electroplated with silver or gold.

90° end bell can be set at 60° interval.

Type AN Connectors are made in 6 styles; straight and 90° cord plugs; box, wall, and extension cord receptacles; and special quick disconnect plugs. Fifteen diameters for inserts with contact arrangements from single to 100 contacts. Contact capacities from 5 to 200 amps. Peak voltages from 70 to 9,000 volts.

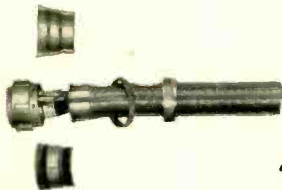

Cannon split-shell design advantages

no assembly tools needed
end bells are interchangeable
no slack in lines
test without disengaging plug
easy inspection and circuit changes

See that your circuit requirements are met. See that all control, communication and power circuits have firm positive contact, low dielectric loss... and see that each circuit is protected by the design advantages found only in Cannon Plugs. AN Connector Series is just one of the many Cannon types—world's most complete line. Request bulletins by required type or describe the connector service you need.

CANNON ELECTRIC

Since 1915

LOS ANGELES 31, CALIFORNIA
REPRESENTATIVES IN PRINCIPAL CITIES

magnetic recording have been recognized for over twenty years, no satisfactory explanation of its action has appeared in the literature. A series of simulated recording experiments was designed to determine the effect of recording gap fields on the final state of magnetization of a recorded tape. It was shown that an-hysteric magnetization alone was not sufficient to explain the bias action. However, if account is taken of the phase of the bias as a particle reaches the center of the gap and if the average value of the magnetization over one wavelength of the bias field is considered, the experiments are in qualitative agreement with observations made on recording machines. These experiments will be described and the new theory of the action of a.c. bias explained.

11:15 a.m.

SPROCKET HOLE TAPE IN MAGNETIC RECORDING

ARTHUR C. DAVIS, *Cinema Engineering Co.*

A discussion of the mechanical, electrical, and electronic problems involved in synchronous drives employed in recording systems. Synchronization being necessary, it is shown to be far simpler to employ sprocket driven recording tape which interlocks directly with the cameras driving the film in TV recording cameras. The various types of sprocket drives are analyzed.

NICKEL ALLOY STEELS

[from page 21]

- L. E. Barton, "High Audio Output from Relatively Small Tubes,"* July 1931.
- B. J. Thompson, "Graphical Determination of Performance of Push-Pull Audio Amplifiers," April 1933.
- J. R. Nelson, "Class B Amplifiers Considered from the Conventional Class A Standpoint," June 1933.
- J. A. Hutcheson, "Application of Transformer-Coupled Modulators," July 1933.
- Paul W. Klipsch, "Design of Audio Frequency Amplifier Circuits Using Transformers," Feb. 1936.
- True McLean, "An Analysis of Distortion in Class B Audio Amplifiers,"* March 1936.
- Loy E. Barton, "Recent Developments of the Class B Audio and Radio Frequency Amplifiers," July 1936.
- E. M. Wise, "Nickel in the Radio Industry," June 1937.
- Geo. H. Fritzinger, "Frequency Discrimination by Inverse Feedback," Feb. 1938.
- H. F. Mayer, "Control of the Effective Internal Impedance of Amplifiers by Means of Feedback," March 1939.
- Karl Spangenberg and Winslow Palmer, "A Phase-Shifting Device for the Rapid Determination of Audio-Frequency Amplifier Characteristics," Sept. 1939.
- F. E. Tenney, R. R. Buss, W. R. Hewlett, F. C. Cahill, "Some Applications of Negative Feedback with Particular Reference to Laboratory Equipment,"* Oct. 1939.
- Horatio W. Lamson, "A Method of Measuring the Magnetic Properties of Small Samples of Transformer Laminations," Dec. 1940.
- John K. Hilliard, "Distortion Tests by the Intermodulation Method," Dec. 1941.
- Wayne B. Nottingham, "Optimum Conditions for Maximum Power in Class A Amplifiers," Dec. 1941.
- Stewart Becker, "The Stability Factor of Negative Feedback in Amplifiers," June 1944.

* Particularly useful in design of audio transformers.

POPS

[from page 38]

tion of 30,000, only 1,000 men could work at anything remotely steady and secure. The rest were ultimately doomed. Living on the typical musician's hope that tomorrow will bring a telephone call from a contractor for a recording session or a new show or a substitute's job, they persisted in the whimsical traditions of the silver lining, tomorrow is a better, and if at first you don't. With increasing yearly unemployment, the situation continued to go from bad to worse until the denouement, which began approximately six weeks ago.

One of the best jobs in music has been radio work. With a moderate amount of security (because there is no such thing as true security in this business), the life of the radio musician was something better than average. But now, radio too has given up the ghost. One broadcasting system is reported to have given notice to almost all the "legitimate" musicians on their staff, a process which is being paralleled by the other networks and will shortly see the total absence of "live" classical music on the air. The doubler (the guy who plays more than one instrument and therefore can be used to cut down on the number of men needed for a specific arrangement) is in his glory and is being almost exclusively used in the "live" dance dates on radio and other media of musical expression. There is a possibility that one of the oldest live classical music standbys on the air may not resume next season (at least live), and the days of another Symphony are apparently numbered.

We have finally entered the peak stage of the canned music era. There will be plenty of opportunity to hear classical music via records. Small local FM stations as well as the networks will continue to play classical music . . . via records. There is even a good possibility that live "pop" will soon see itself displaced by the ten inch spinner. What does it all add up to? One sentence could sum up the whole situation, and if you think this is melodramatic, stay in bed for a few months and then pop your head out into the big wide world and see what's happening. . . .

Potential Death of Serious Music

That's right . . . hold type and a simple stark sentence. If you don't believe me, write, phone, telegraph or visit in person any number of musicians in New York, Chicago, and L.A. and ask them. At long last, the overpopulation problem may be solved. A lot of musicians are already talking seriously about leaving the business. This winter, if things continue as they probably will, a lot more will be engaged in occupations which don't require the ability to read music. What kind of musicians will leave? The best! Further up in the column, I indicated that in a city with a population of 30,000, only 1,000 men were adequately employed. I said nothing about the quality of either the employed or unemployed. Some of the finest musicians in this country belong in the 29,000 unemployed category. What happens when they leave? What happens when kids stop killing themselves in the process of a musical education because they finally realize that the glamorous dream is compounded of tinsel and that they'll probably starve to death if they go into the music business? What will happen to the manufacturers of instruments and accessories when the mar-

Newest AMPEX

HIGH FIDELITY MAGNETIC TAPE RECORDER Model 400

TERMINAL brings you this new incomparable 15,000 cycle performance at 7½ inches per second that equals the performance of 15 IPS full-track recorders and gives 4 to 1 savings in tape cost.



\$795⁰⁰

**2 FULL HOURS OF PROGRAM
MATERIAL CAN BE COMBINED ON ONE 10" REEL**

METER & OUTPUT SWITCH — Position "B" (Level), connects meter "Line Output" plug, and "Phones" monitor plug to the output of the playback for monitoring of playback, while recording or playing back tapes. Position "A" connects "Line Output" plug, and "Phones" monitor plug to the record amplifier for direct monitor of the incoming program. Under position "A" there are three switch positions designated: **LEVEL** — which connects the meter to measure record volume level.

BIAS—which connects the meter to indicate proper record bias.

ERASE—which connects the meter to indicate proper erase current.

SPEED CHANGE — Toggle switch permits quick choice of 7½ or 15 i.p.s. tape drive speeds.

RECORD BIAS ADJUSTMENT — Biased for maximum output of 1000 cycle tone (factory adjusted).

7½"-15" EQUALIZATION — Adjusts electronics for proper operation at 7½ or 15 i.p.s.

INPUT TRANSFER SWITCH — Properly connects input plug for: I) 200 ohm microphones such as R.C.A. 44BX, KB-2C, etc. II) Balanced bridge for bridging telephone lines or balanced studio lines. III) Unbalanced bridge 100,000 ohm input for radio tuner, phono pre-amp, bridging public address equipment or unbalanced studio lines.

FOUR-INCH "VU" METER — Volume level meter used to indicate proper record volume level. This instrument can be switched for several functions as listed under "Meter & Output Switch."

OUTPUT LINE TERMINATION SWITCH — Places 600 ohm terminator across amplifier when same is not externally loaded (this is necessary for proper meter calibration).

OPERATION SELECTOR — Switch provides for normal forward or fast forward or fast rewind.



FREE WRITE FOR
YOUR PORTFOLIO OF
15 IDEAS FOR CUSTOM
RADIO-PHONOGRAPH
INSTALLATIONS.

This profusely illustrated booklet gives you actual photos of installations in typical room settings.

**VISIT US IN ROOM No. 622
AT THE AUDIO FAIR OCT. 26-28**

TERMINAL

RADIO CORPORATION

Distributors of Radio & Electronic Equipment

85 CORTLANDT ST., NEW YORK 7, N. Y. • WOrth 4-3311 • Cable: TERMRADIO

ket is reduced to zero? And, the most important question, what is going to happen to the quality of musicians and orchestras?

It is now time for you to shrug your shoulders and emit coy little exclamations like, "Nonsense," "Pshaw," "Impossible," "Fantastic," "Unbelievable," "Whosehe-tryintascare" and "Whaddyaknow," but it's true . . . yep . . . all true, and if you want the proof, a little investigation and statistical study will bear me out.

This column cannot go into the economic details of the situation or probe around the ideas for subsidization, etc. However, this column can and will take a nasty swipe at the one aspect of the situation which is directly within our frame of reference . . . wreckords. All we wreckord geniuses have been spouting the gospel about the superior-

ity of the canned goods for years now. Were we right? Nah! Did people take us seriously? At long last, yes! Should they have? Nope!

No matter how you stretch it, no matter how many text books, articles, theses are written year after year, no record and no record reproduction machine has or will be able to supplant live music. The audio engineer and the subsidiary groups working with him have been concerned with very real and very practical problems involving motion picture sound tracks, auditorium amplification, tape reproduction, etc. Their ends were very simple . . . to achieve a level of sound reproduction which either came as close to the original performance as possible or handled the material to be reproduced accurately in terms of the ends in-

involved. Because of improvements in equipment and the gradual sophistication of theory, it was possible to reach a stage of accomplishment pretty close to the theoretical optimum. Are we therefore justified in replacing live performances with records?

As far as I am concerned, the answer is *no*. There are some audio prophets who maintain that it is still possible, despite present skepticism, to achieve perfect reproduction on records. Despite the thousands of problems, including the acoustical limitations of the average living room, the limits of the average purse . . . assume that perfect reproduction is indeed possible. Are we still justified in limiting musical experiences to records? The answer is again *no*, and for what may be considered an extraneous reason. It is now possible to achieve performances on records which are technically, in the musical sense, perfect. No clinkers, no mistakes need appear in a recorded performance. Tape editing has been reduced to the utmost simplicity, and passages which in the original take were inadequate can be repeated and edited in. Is the earmark, hallmark, and questionmark of a good performance the absence of clinkers? Nope! A good performance is a totality which is and must be seen in terms of untechnical factors, including phrasing, tempi, balance, etc. There has never been and never will be any one performance which is so perfect that a listener with a good ear and with a moderate amount of musical sophistication would want to hear it over and over again, unchanging, and always played and heard under the same conditions.

There is a special kind of excitement involved in a live performance. The specific performance can never be repeated, and despite the number of rehearsals and the quality of the orchestra and the conductor, cannot be perfectly anticipated. Certain ineffable psychological factors enter in which cannot be overlooked . . . the spontaneity of even the best rehearsal program, the particular attitude and calibre of the audience, and so on. The audience-musician relationship is one of the most vital factors that goes into the making of the great moments in music. Without it, music is reduced to the level of a photostat, reproducing what is on the printed score, but lacking the particular and quintessential reality of the original. Quality musicians result from the eternal battle (a face-to-face battle) which results in the concert hall between musician and audience. Quality musical performance results from the generation of a particular emotional response out of the details of the moment. The artist, the performer, whatever you want to call him, must work for somebody, must act, perform and do for an immediate somebody. Without the somebody, he is dependent upon a strength of character and an absence of egoism which cannot be expected even of the strongest of men. The electricity of the great concert is not recordable.

Records were created and are made to serve a dual purpose; they augment and temporarily replace the concert hall. They are a temporary convenience, and nothing more. Where live music is inaccessible, they are a necessity. Where it is accessible, they help solve the problems involved in a limited concert season and a limited repertoire. They are meaningful only if they augment the real thing. The psychological advantages of seeing as well as hearing are obvious and need not be mentioned. The communion between musicians and audience is also obvious. Without the communion, without the audience-musician battle, with-

MAGNETIC
RECORDING
TAPES TO
THE HIGHEST
PROFESSIONAL
STANDARDS

Now the well-known Duotone super-quality is available in magnetic recording tapes for commercial and home recorders. The six Duotone quality features assure finest sound reproduction for professional programming and the ultimate in home entertainment. For finest performance on any tape recorder, use Duotone professional quality magnetic tapes!

- Interchanges with Other Tapes
- Constant Tracking and Winding
- No Snarls or Backlash
- Low Inertia Plastic Wheel
- Low Friction—Long Life
- High Output—Minimum Background

DUOTONE SUPER QUALITY IS AVAILABLE
IN TAPES FOR EVERY RECORDING NEED

Made with plastic or kraft paper base in extra long 625 or 1250 foot lengths. Plastic base is tough with high tear strength and special smooth finish for uniform coating. All kraft bases are super-calendered for perfect surfacing without fillers. For complete data on Duotone standard and special tapes, call or write for illustrated catalog.



Canadian Representative: CHARLES W. POINTON, TORONTO, CANADA
Export Division: AD. AURIEMA, INC., NEW YORK CITY, N. Y.



NOW-famous
DUOTONE
quality...

— IN A
**RECORDING
TAPE**
FOR EVERY
PURPOSE

*6 WAYS
to better
Recordings*

out the precariousness of the performance which cannot be repeated, but can only be played once (you cannot go back and repair mistakes during a concert), music and musicians are reduced to the level of mechanical auxiliaries to a cutting stylus. Quality degenerates (and Mr. Canby can certainly testify to this in the modern history of recordings) to a mediocre mean. A recorded performance need satisfy only the average and is impervious to the screams of the demanding.

But this is really only an academic discussion. The perfect record is hypothetical, the perfect reproduction apparatus is still theoretically out of the question. The transparency and liquidity of pianissimo passages, the tension and accuracy of *tutti*s, played fortissimo, the whole area of sound subtlety is absent. We are easily fooled by the illusion and allusion of their presence in some of the better recordings of recent years, but they just aren't there. To a group, brought up on the musical horrors of AM radio presentation, modern recording sounds tremendous. Get them back into the concert halls for a while (assuming they don't all have tin ears) and the myth is easily dispelled.

If you agree with the above, I assure you that the crisis as described earlier exists. At the moment, there is no ready solution. One thing is certain, if you will be content with a few hours of hoof beats on the range, videoed seven days a week, and if you are content with the present state of affairs, nothing will happen. Since competition among musicians will cease, recordings will become more and more mediocre. Fewer and fewer men will come into the business (the job opportunities presented by the recording industry are extremely limited), and musical standards will reach an unbelievable low. Of course, it may eventually be possible to dispense with musicians entirely. If you like that idea, we might as well all give up and learn to appreciate the human sounds of a sneeze.

All and every kind of music is involved. The people who still count are the guys and gals who have loose change in their pockets and can determine the direction any industry moves. If you don't buy records, if you don't listen to canned radio broadcasts, if you refuse to go to concerts because of inadequate musicians and inadequate conductors, changes will have to be made. If you want to hear good jazz, good pops, good serious music, you have to make it possible for the people responsible—the musicians—to stay alive and achieve some form of artistic and economic security. If you have any pride in the records you have or in the equipment that plays them back for you, you will demand that what goes onto the discs is first rate. I have outlined the conditions which are and will continue to jeopardize such a possibility. Who gives a hang for perfect equipment which reproduces trash? I don't! I'm angry and frightened about the prospects . . . it's about time that you were.

NEW RELEASES:

Charlie Parker With Strings

Mercury MG 35010

I was introduced to this new LP release by one of the noble Pop "critics" so casually dismissed before. I was told in ecstatic terms that this was one of the greatest things that had ever happened . . . that I would revel in its mellifluous and tonic vibrations . . . and that there was none better. So sorry . . . but . . . it's all nonsense. I will quote

For Matchless Performance—Use

CHICAGO

MATCHED

Power Transformers & Filter Reactors

Optimum performance is no accident. CHICAGO transformers insure optimum performance, first by advanced design geared to today's electronic tubes and circuits, second by famous Sealed-in-Steel construction, and third by matching associated units to perfection.

Electronic designers, engineers, experimenters and builders are fast learning about CHICAGO advantages. There's proof in the increasing preference for Sealed-in-Steel power units. They're exactly suited to requirements—one range of ratings specifically designed for capacitor input, another for reactor input. Filter reactors are perfectly matched to power transformer units both in rating and construction characteristics. For a complete range of matching units, designed for *matchless* performance, you'll want to refer to the CHICAGO New Equipment Line Catalog. Send for your copy today.



Full Frequency Range Audio Transformers

within $\pm \frac{1}{2}$ db
30-15,000 cycles

For uniformly low distortion, for response curves that are truly flat over the full frequency range, use these famous CHICAGO Sealed-in-Steel input and output units. Get the facts on the BO-6 (P-P 6L6's to 6/8 or 16/20 ohm speaker), the BO-7 (600/150 ohm line to 6/8 or 16/20 ohm speaker), and the full line of CHICAGO full frequency units—years ahead in audio transformer design—tops for performance.

Public Address Range Audio Transformers

within $\pm \frac{1}{2}$ db
50-10,000 cycles



CHICAGO P.A. range units are geared to today's public address circuit requirements and to latest tube types. Line and voice impedances used in the advanced Sealed-in-Steel output designs meet RMA standards. The 4, 8, and 16-ohm voice coil impedances can also be used with 3.2, 6 and 20-ohm speakers without appreciable mismatch. Available in a complete range of perfectly matched driver and output units.



SEND FOR FREE NEW EQUIPMENT LINE CATALOG

You'll want the full details on CHICAGO'S New Equipment Line—the famous Sealed-in-Steel line that offers advanced engineering design to fit today's circuits. Lists units for all purposes: Power, Bias, Filament, Filter Reactor, Audio (in 3 frequency ranges), JAN-T-27, Modulation, Stepdown and Isolation, High Q, Splatter, Low Pass. Write for your FREE catalog today—or get a copy from your distributor.

CHICAGO TRANSFORMER

DIVISION OF ESSEX WIRE CORPORATION

3501 ADDISON STREET • CHICAGO 18, ILLINOIS



from Norman Granz's blurb on the back (Granz supervised the session) and then fill in my own comments:

"All of the music in this album shows a new Parker to most listeners. He plays the melody very closely and it's good that he does, for the tunes are truly beautiful. He plays with strings and some of the harsh effects achieved heretofore by Parker et ensemble are nowhere noticeable here, the strings softening and prettying Parker; and Parker, for the first time, plays with truly great musicians which meant he had to be, as it were, on his best musical behavior.

"Incidentally, there's been much talk about the so-called 'new sounds' in jazz: I hope you like the '... sounds' in this album."

A few words about Charlie Parker to begin with. Parker was the recording protégé of Ross Russell, a sincere guy who made a natural musical transition, as demonstrated by his Dial Records, to modern classical in the form of Alban Berg, Schoenberg, et al. Parker was pushed as a genius and was one of the loftiest during the bop craze. I have never agreed with the general estimate of Parker. To put it bluntly, I don't like. But this recording isn't his fault. The same thing that happened on the Shaw date, reviewed previously, has happened here. Only now, the arranger is pretty much at fault.

To begin at the beginning, balance is ridiculous. I wasn't at the date, but either

Parker has the mike attached to his sax mouthpiece, or they shoved the orchestra into another room. All that comes through is an unearthly sax blast, with a chaotic mish-mash of accompaniment floating in the background at so low a level, as compared to the sax, as to cause suspicion that another recording, being made in the next studio, drifted in. The arrangements are violently bad. There is no clear stylization. Oboe comes threading in against bad percussion breaks... string writing is muddled. Harp use is ridiculous in the context of the arrangement at points... and Parker... poor Parker... is way out of his depth. The whole thing is nonsense from beginning to end... and this is what I mean by bad supervision. On every level... technical, musical, (and business) a rousing raspberry. When will they ever learn that mikes cannot be used like salt! Even the pressing isn't so hot... Sorry Mr. Granz, I don't like the "... sounds" in this album. For those who are interested (and to Parker lovers, the titles should indicate something) the bands are as follows: April in Paris, Summertime, If I Should Lose You, I Didn't Know What Time It Was, Everything Happens to Me, Just Friends.

Marlene Dietrich Souvenir Album

Decca DL 5100

This is, of course, nothing new, except that it's out on a ten-inch LP. We are great admirers of La Dietrich, and two of the babies included are magnificent... I've Been in Love Before, and Symphonie. On originals, they should be purchased by all and sundry... they are marvels in stylization... and who worries about quality when Dietrich is on a disc. But... another point. Here is a case where I can throw whole-hearted support behind Victor and the '45. Except for the cases mentioned in past columns (jazz, and things requiring more than the normal three minute playing time), the LP, whether 10 or 12 inch, imposes a tyranny on the consumer as far as pops are concerned. Along with the one item in a dub, it is necessary to buy all the rest of the junk. Decca has also come out with a 10-inch LP called "The Man with the Horn" (DL 5191, if you're interested) which features Armstrong, Berigan, Spanier, Eldridge, Hackett, Brooks, Butterfield, McGhee. I, for one, wouldn't want some of the stuff on this baby. But what to do. I'm stuck with it anyhow. Outside of space (and there are too few people who own enough records to have to worry about space), there is no advantage to these dubs. There is, as indicated above, a decided disadvantage. Either the Victor 45 or the Columbia 7-inch takes care of the problem. I don't want anybody to impose his selection on me... and you probably don't exactly crave it, either. Furthermore, I want to load discs on a changer in my own order... not an order imposed by band separation. On top of it all, the Dietrich dub is a particularly bad one. Noisy and muffled, you will do better to get the old shellacs. They are still available (including a large quantity on H.M.V. and Polydor, which are luscious).

NOW! You can SWITCH to AFC with BROWNING!

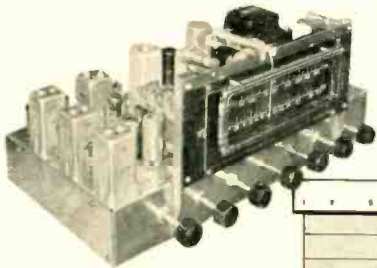

"On" or "Off" AFC on FM as you prefer — for unequalled performance and precise FM tuning. Included in all Browning tuners.

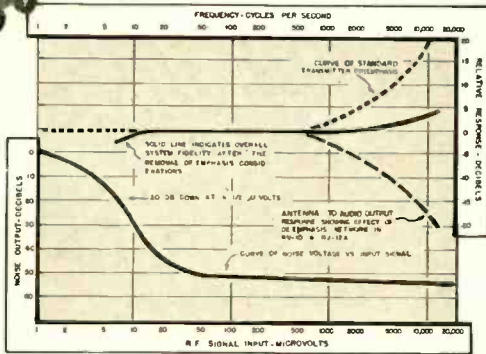

These are the performance curves which, to the man who knows radio, mean high-fidelity reception, flawless and noise-free.

And the non-technical listener who demands the best — brilliant music, clear speech, with lifelike "presence" — will know he has it just the instant he hears Browning FM and AM.

MODEL RJ-20A AM-FM TUNER

- Armstrong FM circuit; 20 db quieting with 6 1/2 microvolts.
- FM response 15-15,000 c.p.s. ± 1 1/2 db.
- Separate RF and IF for FM and AM.
- 20 db treble and bass boost.
- Variable AM bandwidth, 9 kc. and 4 kc.
- Tuning drift-free, precise.
- Self-contained power supply.

MODEL RJ-12B FM-AM TUNER

High-sensitivity tuner for distortion-free FM and quality AM. Armstrong FM circuit. Drift compensated. FM audio flat 15-15,000 c.p.s. ± 1 1/2 db. AM audio flat 20-6,600 c.p.s. ± 3 db. Triple-tuned i.f. Easy to install.

MODEL RV-10A FM TUNER

Small, compact, easily mounted. Armstrong circuit. Drift compensated. High-impedance output to feed any high-fidelity amplifier. Self-contained power supply. Audio flat 15-15,000 c.p.s. ± 1 1/2 db.

Write for a complete set of characteristic curves and performance data for any or all of these Browning Tuners.



RECORD REVUE

[from page 38]

neering thrown in. People don't come that way, though. Nor can the editor appoint a Committee of Ph.D.'s to consult and produce articles, monthly, on Audio Relations. Very few trained audio engineers could do it; engineering is not a profession that allows time on the side for training in the art of writing deathless prose, not to mention the complex sciences of music, psychology and the rest. Moreover, most engineers in any field are understandably too near the trees to see very much of their forest.

Birdseye View

Hence what you have before you, represented in print hereby. A musician officially, who happens to be a frustrated engineer at heart as well; an outsider, who knowing only a few of the major trees by their first names, manages every now and then to get a good birdseye (what am I writing?) view of a sizeable hunk of forest, in the audio area. No amateur engineer can expect to keep up with genuine Joneses in the professional engineering world, and there are plenty of things that this column will never be seen talking about in print. Leave 'em to the rest of the magazine.

But, on the other hand, as I muttered a couple of times three years ago, it's often useful to have fools rush in where engineers would rather not tread. Boners, technical ones especially, are not guaranteed absent here, in spite of the watchful eye of the editor. But if this column, boners and all, Record Revue or not, can stimulate interest, thought, even action in the audio field which redounds to audio's good (and if it makes reasonably entertaining reading . . .), then the job is done. And remember, if I make a boner, it's only me, a musician; whereas if you trained professionals do it, woe unto you! Gives me a peculiar kind of freedom, but also a peculiar responsibility: Let the little boners pass, but *don't* make big ones.

So, new subscribers, on to the Record Revue (below) and no more of this for another three years.

Tchaikowsky, Symphony #6 ("Pathétique")

a) Vienna Philharmonic, Von Karajan
Columbia LP:
ML 4299

b) Paris Conservatory Orch. Munch.
ALSO, same album:

Tchaikowsky, "Romeo and Juliet."

a) London Philharmonic, Van Beinum.
London LP:
LLP 167 (2)

b) New York Philharmonic, Stokowski.
Columbia LP:
ML 4273

One gets into complex fractions trying to make comparisons these days—here are two pieces, three recordings, in a sort of siamese-twin relationship.

These records, technically speaking, throw some interesting light on rival recording techniques. The Columbia "Pathétique" is one of the first all-British LP's, done by English Columbia, only the final pressing managed in the U. S. by our Columbia. (Another, the Haydn Symphony #100, appears below.) It competes directly, then, with the famous firr London LP recording. Results: a quite different sound, though each is clean, low in distortion. Strangely enough, in direct comparison, it

SUCCESSFUL

because they have the Right Disc Recorders

THE LARGEST INDEPENDENT RECORDING STUDIO IN THE EAST SAYS: "We've been using Fairchild Disc Recorders exclusively for many successful years. They stand the test of continuous operation with high quality output. That's the international reputation of the work we turn out—high quality!"

Mr. C. L. Stewart, Business Manager,
Reeves Sound Studios

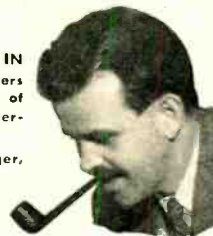

MERCURY RECORDS SAYS: "Reeves-Fairchild Thermo-Dynamic Margin Control represents an unbeatable combination . . . puts Mercury Records at the top in progressive recording techniques".

Mr. David Hall, Musical Director of Mercury Classics

With Fairchild's exclusive features, you too can be successful in the new markets for low noise LP, TV and Theatre film sound track recording.

The FAIRCHILD STUDIO RECORDER with pitch-variable-while-recording is shown on the right. No lead screws or gears to change. Continuous pitch change from 80 to over 500 lines per inch simply by rotating the convenient knob. This is the famous MARGIN CONTROL which puts up to 25% more recording time in the same space—without reducing top recording levels.

70 db dynamic range on disc is now made possible with the Fairchild THERMO-STYLUS and MARGIN CONTROL—"an unbeatable combination".



Fairchild Synchronous Disc Recorders



Accurate Program Timing—Synchronous direct to the center gear drive for "shows on the nose".

Freedom From Wow—No slippage. No musical pitch change to make listeners aware the show is transcribed—extremely important at 33 1/3 rpm.

Sound on Film Dubbing—Many of the motion picture sound tracks you hear and enjoy are first recorded on Fairchild Synchronous Disc Recorders.

Microgroove and Standard Pitch recording can be done with any of the 3 Fairchild Disc Recorders: Unit 523 for the finest fixed installation, Unit 539-K for the small budget studio, Unit 539-G (shown above) for console performance in a portable case. Fairchild "sync-disc" recorders for standard and microgroove recording are made in 3 models, from \$715 (less cutter head and pickup). Write for illustrated literature today.



154TH ST. AND 7TH AVE.

FR 110
**WE'RE
AT THE
AUDIO
FAIR
OCT. 26-28**

WHITESTONE, L. I., N. Y.

is the British Columbia which has the distant-mike, over-all sound, the London which seems as though done with a closer pickup, individual instruments standing out sharply, the strings with that typical wiry, metallic quality. Even more: the "Romeo and Juliet" recording—though here London competes with American Columbia—brings out a similar difference; the New York recording is the more distant, over-all, the London is drier, closer, sharper.

Whatever the techniques of mike placement used (and this is your guess as well as mine), the two sounds here represent examples of an old argument. Without much doubt, most engineers will prefer the closer, sharper London sound, and possibly so will musicians at first—it's super-realistic, over-natural. But in the end, for pure musical pleasure, the more distant technique is best for music like this. Why? Because it was

written to be heard that way, in the binaurally equivalent situation.

Not much space for the music—I find that Von Karajan's "Pathétique" is the more exact and more musical performance; Munch's is nearer to the usual noisy weeping-of-salt-tears we get so frequently. On the other hand, Stokowski's wisely experienced way of handling the powerful stuff in "Romeo" brings his up ahead of Van Beinum's. Stokowski can be a craftsman when he's in the mood.

Haydn, Symphony #100 ("Military").

Liverpool Philharmonic, Rignold.

Haydn, Symphony #94.

Liverpool Philharmonic, Sargent.

**Columbia LP:
ML 4276**

Same orchestra, same composer—but one

of these LP's, #100, was processed entirely in England except for the final pressings here; the other, #94, was re-recorded and made into an LP here as other British records have in the past. So, at least, is my information. (See matrix numbers.) Neither of these, alas, is anything exceptional as to sound, so the comparison is not as good as it might be. The British-made LP master seems to have more bass than the U. S., whereas both have relatively flat high ends, as do most Columbia LP's originating in Britain. Very noticeably different in this respect from any domestic-recorded orchestral LP out of Columbia. The U. S. LP, my copy at least, is a poor cut, with unpleasant distortion; quite possibly this is absent in other copies. Musically, both of these are good, standard performances of Haydn, not tops but easily listenable.

LOOK HEAR

better
than your ears

- 12 to 22,000 cycle flat frequency response, 20 watt output
- less than 1/2 of 1% harmonic distortion at 20 watt output
- less than 1/10 of 1% difference-tone intermodulation distortion at 20 watt output
- automatic loudness control maintains constant tonal richness at all volume levels without causing "boomy" speech. Works on "highs" as well as "lows"
- up to 32 db bass-boost at 30 cycles, in addition to pre-amp compensation
- up to 23 db treble boost at 15,000 cycles
- hum level 80 db below output at maximum loudness settings, 84 db down at low loudness settings

Hear remarkable performance from a remarkable amplifier at the 1950 AUDIO FAIR, room 528. Also shown *** the new 212-A remote control amplifier, the DYNAURAL noise-suppressor converters, and the H. H. Scott sound measuring instruments.

H. H. Scott's NEW DYNAURAL amplifier 210-B



Built by the world's leading manufacturer of sound measuring instruments. Built with old-line integrity of design, workmanship, and performance. An amplifier you will be proud to play for friends, it almost brings artist and orchestra into your living-room. In every way, an investment in years of listening enjoyment.

The new DYNAURAL noise-suppressor virtually eliminates record surface-noise and turntable rumble, and without losing "highs" or "lows". Each note is crisp and clear, unmarred by noise, distortion, or recording unbalance. Improves all records, LP and standard, new and old. Protects investments in worn old records otherwise too noisy to play. The finest amplifier for fine music. Word-of-mouth recommendations from DYNAURAL owners have prompted more new purchases than any other reasons. The new 210-B DYNAURAL amplifier now \$189.50 at your radio-parts distributor. Write us for free bulletin AE210.

Tchaikowsky, Violin Concerto.

a) New Symphony Orchestra, Sargent;
Ruggiero Ricci. **London LP:
LLP 172**

b) Philadelphia Orchestra, Hilsberg;
Isaac Stern. **Columbia LP:
ML 4232**

Back to Tchaikowsky—here are two performances of the violin concerto by not-so-big-name artists, both of whom tend to take this florid music in fairly conservative, well-mannered style. As far as I'm concerned, that's just what the music needs; but you'll find that Isaac Stern is not only well mannered, but his performance has a greater sense of depth and dignity than does Ricci. The Philadelphia orchestra does an unusually acute job under sub-conductor Hilsberg. (These Assistant and substitute conductors with unimportant sounding names sometimes turn out top rate music.) Moreover, the Columbia, for once, is really a better recording acoustically than the London, with a natural, distant violin, well blended with its orchestra. Ricci is close and dull sounding with a false relation between violin liveness and orchestra liveness.

Wagner, The Flying Dutchman.

Complete opera.
Soloists, Chorus, Orchestra of the
Bavarian State Opera;
Klemens Krauss.

**Mercury LP:
MGL 2 (4)**

This is an epoch making recording if only because it's the first complete or reasonably complete Wagnerian opera to appear on LP records. Taken from a broadcast (so I hear), the recording is nevertheless excellently done from the point of view of acoustics and balance between orchestra, solo voices and chorus. The music is, thanks be, very much alive (so many utterly mediocre LP's are coming from Europe these days), and the voices are splendid except for the soprano, who isn't overly important. If you want to feel the enormous advantage of LP for yourself—just try a side or two of this. Wagner, after all, depends on long-term build-up of musical and dramatic tension; the old 78-r.p.m. record, in spite of heroic recording efforts, never could approach it. Technically these aren't wonderful—the big voices are overcut in loud parts, highs are lack-lustre. But acoustics, performance, make up for it. It's a grand opny, too!

Smetana, "From My Life" (Quartet in E minor) arr. orchestra by George Szell.

HERMON SCOTT, INC.
"PACKAGED ENGINEERING"
385 PUTNAM AVE. • CAMBRIDGE 39, MASS.

Cleveland Orchestra, Szell.

Columbia LP:
ML 2095 (10")

The transcribing of music, from one instrumental medium to another, is one of the most dangerous—and fascinating—of musical licenses; it involves, to be successful, a taste and skill in the transcriber equal to that of the composer. We've had dreadful transcriptions—here's a fine one. This is perhaps Smetana's greatest work (not counting operas): it's rarely heard by most of us. String quartet music usually makes bad orchestral stuff, and some of this isn't more than overstuffed quartet playing—but most of it is vital and exciting. The second movement, one of the most moving of pure Romantic pieces I've heard, is something you shouldn't miss. Clear, distortionless recording, one of those that you want always to turn a little higher—the music sounds too distant. It'll take it here, and you'll find Szell's playing superb; the louder the better.

Mozart, Concertone in C Major, K. 190;
Symphony #23, K. 181.

Members of Vienna Symphony, Swoboda.
Westminster LP:
WL 50-13

Mozart, Serenade #5, K. 204;
Symphony #22, K. 162.

Members of Vienna Symphony, Swoboda.
Westminster LP:
WL 50-5

Karl Stamitz, Sinfonia Concertante in F
for seven solo instruments.

Vienna Symphony, Swoboda.
Westminster LP:
WL 50-17

These are but samples of the increasing line of extremely interesting Mozart and Mozart-period items being dug up and tape-recorded in Vienna by Westminster. None of these has been recorded before, to my knowledge—few have ever been heard at all in this country. Yet every one is of a great deal more than passing interest, and some of the items are absolutely first rate; moreover the performance averages far above the run of current hastily-put-together LP's of similar music, and technically I'd say this company has set a standard of excellence that is actually above that of the major companies in the field! That is, sight unseen, I'd trust a Westminster LP, at this point, to be satisfactorily wide range, distortion-free, with good balance and acoustics much more quickly than I'd trust any major-company LP except perhaps London's recent output. All goes to show what astonishing things LP has meant already.

No room for details as to the above music, except that the Serenades, etc. are "in-between" music, not "chamber" in our sense, not quite orchestra; more a small orchestra of solo instruments. As any recording engineer knows, these in-between combinations are the ideal material for recording—whether 18th century or 20th—and a comparison with the early Mozart symphonies here, for somewhat less solo-like groups, will show the difference in clarity immediately. Karl Stamitz was one of the pioneer Mannheim composers who developed the style which Mozart used, now usually called by us the "Mozart" style. Listen and you'll see where Mozart got his musical language (The Stamitz, incidentally, is the first Westminster I've hit that is under par in the cutting—it distorts in my copy.)

You'll find an equivalent series of interesting minor Romantic works in the Westminster series, also well recorded—Suk, Goldmark, Rimsky-Korsakov, R. Strauss, and so forth.

TECHNICANA

[from page 6]

made use of a simple photographic technique. A small lamp is moved up and down as it traverses one plane in the sound field. The intensity of the light is varied in accordance with the amplified voltage from a sound level meter fed by a microphone adjacent to the

light bulb. The photography is done in a darkened room. With the camera focused on the plane to be traversed the picture of the radiation is formed by a series of scanning lines in the same manner as a television picture. The photographs were taken with a Polaroid-Land camera to facilitate readjustment of the apparatus until high quality pictures were obtainable.

Reflexed Radio Receiver

A new and easily constructed version of the familiar reflex circuit radio receiver is discussed in the Brazilian journal *Revista Radiotecnica*. This circuit,

RCA Two Names You Can Depend Upon...
HUDSON
RADIO & TELEVISION CORP.

★ **RCA for Top Quality Equipment!**

★ **HUDSON for Best Value—Dependable Service!**

Our New Giant Store and Warehouse—3 Great Floors—features a Complete Line of RCA Equipment . . . Tubes, Batteries, Test Equipment and Parts . . . for Immediate Delivery or Shipment to All Parts of the World!

RCA WV-97A SENIOR VOLTOHMYST

The WV-97A has a range of usefulness far beyond any other instrument in the field! Its quality, dependability, and accuracy make it ideal for TV in design laboratory, factory, and service shop. The Senior VoltOhmyst measures dc voltages in high impedance circuits, even with ac present. It reads rms value of sine waves and peak-to-peak values of complete waves or recurrent pulses, even in presence of dc. Its electronic ohmmeter has a range of 10 billion to one. Outstanding as a TV signal tracer. Includes direct probe and cable, dc probe, ohms lead, ground lead.



No. A14Net **\$62.50**

NEW! RCA 515S2 15" Duo-Cone SPEAKER

The newest development of Dr. H. F. Olson, RCA's renowned speaker authority. Delivers 25 watts of high fidelity audio over range of 40-12,000 cycles. Has two voice coils, each driving one of the duo-cones, which vibrate as a single cone, at crossover frequencies (around 2,000 cps), avoiding "crossover" interference. 2 lb. Alnico V magnet. Performance is amazing! 18 lbs.



No. A53, RCA 515S2 Speaker.....Net **\$48.50**

RCA Model 515S1 15" Speaker, No. A52.....Net **\$35.57**

RCA TELEVISION COMPONENTS

All RCA Television Components are "originals," designed with characteristics which are correct both electrically and mechanically for the tubes and circuits. They are "performance" proved and competively priced!



RCA INDUSTRIAL TUBES — Value Beyond Price!

RCA's unparalleled research facilities, engineering background, and manufacturing experience contribute to the quality, dependability, and operating economy of EVERY RCA tube you buy. The Quality of RCA tubes is Unquestioned!



FREE! SEND FOR OUR NEW 1951 CATALOG



212 FULTON STREET
NEW YORK 7, N. Y. • Digby 9-1192



Hudson Radio & Television Corp. Dept. 10A
212 Fulton St., New York 7, N. Y.

Please send: RCA WV-97A 515S2 Speaker
 Full Payment Enclosed
 Down Payment (10%)
 SEND FREE HUDSON CATALOG—Just Out!

Name.....
Address.....
City.....Zone.....State.....

Most Complete Stock of Radio, TV, Electronic and Sound Equipment in the East!

ANNOUNCING NEW, MODEL 1401

Plays 10½" Reels!



Complete, for console installation with single or dual track heads:

\$345.00

CONCERTONE

□ The professional quality tape recorder you have been waiting for! NAB standards; triodes throughout; 40-15000 cycles at 15", 40-8000 cycles at 7½". Three motors; flutter less than 0.1%; signal-to-noise better than 50 db. Three heads for simultaneous erase, record, playback. Quick change from single to dual track. Write for booklet.

FISHER RADIO CORPORATION • Distributors • 45 E. 47th St., N. Y.

AMAZING . . . EXCLUSIVE

True, Full-Range Fidelity

BOZAK
Kettle Drum Speaker

CLEAN, PLEASING TREBLE
ROBUST, LIVE BASS

Acclaimed By Musicians, Engineers!

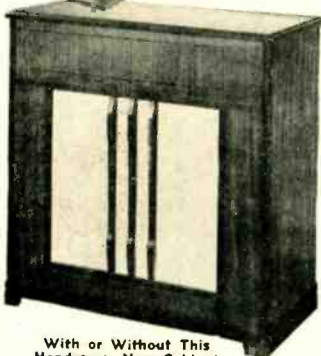

With or Without This Handsome, New Cabinet

An entirely new experience in music and voice reproduction awaits you in this unique Kettle Drum Speaker . . . a Bozak exclusive! Truly, you'll be moved by the live, undistorted tone—the unparalleled listening ease at any level, achieved by this fine Bozak instrument. And you'll be amazed at the low price.

If you have high quality sound sources . . . if you appreciate and demand highest quality reproduction, the Bozak Kettle Drum is your speaker . . . your only speaker.

And now, if you prefer, it's available in a handsome mahogany cabinet at a modest, additional cost.

Write for descriptive literature, and the name of your local dealer.

R. T. BOZAK CO.
90 Montrose Ave. Buffalo 14, N. Y.

Fig. 1, uses one tube for the dual purpose of r.f. and a.f. amplifier and rectifier. In previous reflex circuits only the former dual function was performed, but with the use of the dual section 117L7 which contains a beam power amplifier and a half-wave rectifier it is easy to obtain all three functions. The construction is simple and the quality claimed is adequate. However no distortion figures are available and no values of required input signal strength were given. None the less the circuit provides a simple receiver for shop or monitor use.

Magnetic Recording

"Adjustment for Obtaining Optimum Performance in Magnetic Recording" is the title of an article by Albert W. Friend appearing in the March 1950 *RCA Review*. It reviews briefly the fundamentals of tape recording as an introduction to the problems of noise and second harmonic distortion. These are attributed to magnetization of the recording head or direct current in the recording coil. The effect of switching transients of large magnitude is to produce a direct current bias through mag-

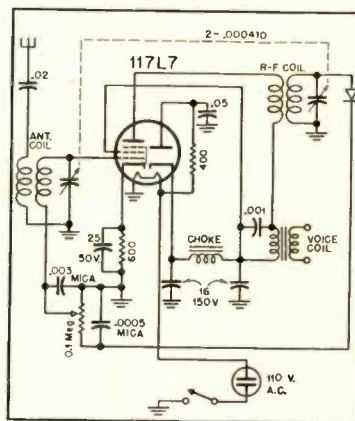

Figure 1

netization also. Any of these resultant d.c. biases raises the noise level, in the same manner that the signal produces modulation noise, and increases the second harmonic distortion. It is also stated that pre-polarization of the recording medium produces the same effect as a d.c. bias on the recording head. Using extremely precisely made heads, RCA P-4, the results of cancellation of the d.c. bias by the application of an external d.c. signal were studied and the reduction of both noise and second harmonic was considerable, as was predicted. The adjustment of the system for either minimum second harmonic or minimum noise requires the same value of d.c. correcting bias, and simultaneously reduces higher harmonics.

The remainder of the article shows the

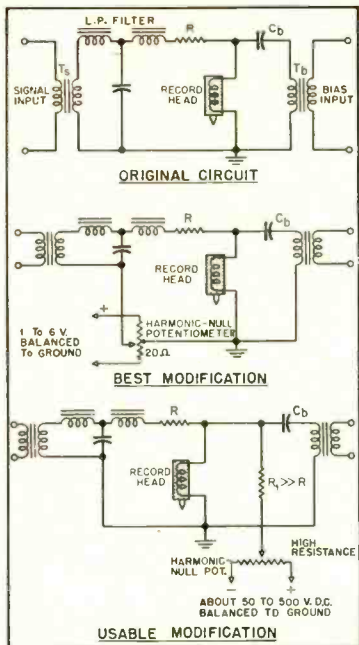

Figure 2

test results of a tape recording system using the P-4 heads and MMM 111 recording tape under varying conditions of signal and bias. Figure 2 shows the original recording circuit and two equally satisfactory modifications for obtaining the d.c. bias to reduce noise and harmonic content.

Telephone Repeaters

A thorough review of voice frequency repeaters is carried in the *Automatic Electric Technical Journal*, April 1950. In an article by H. C. Talcott the design of the Automatic Electric Type 47 VF Repeater is detailed. The need for toll telephone line repeaters is shown by the example using 1000 miles of 16-gage loaded cable, which has a loss of 190 db. Instead of trying to compensate for this loss at any one point repeaters are spaced about every forty miles. One im-

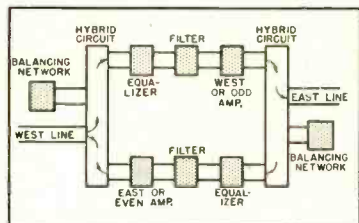
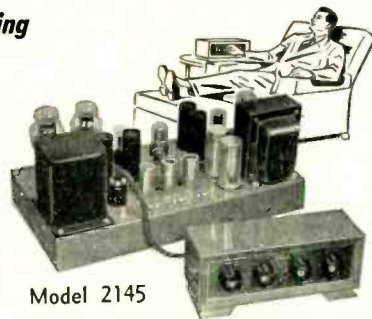

Figure 3

portant consideration in voice frequency repeaters is that the input and output amplifiers feed only one pair of wires each. Therefore without any intermediate device it would be impossible to obtain anything but feedback singing from a

BELL offers you something new in a Custom HIGH FIDELITY AMPLIFIER

with complete Remote Control



Model 2145

This unique, new Bell High Fidelity Amplifier adds the master touch to any type built-in or custom audio system. Its remote controls, in an attractive unit for table or console mounting, are amazingly selective. Include single selector for phono—AM, FM radio (or TV), all domestic and foreign records, 78, 45, and 33-1/3 rpm; also compensated volume control; plus smooth, continuously variable bass and treble with boost and cut. All-triode amplifier, 30 watts maximum, reproduces sound at all levels, naturally clear and life-like.

Frequency response plus or minus .25 db 20 to 30,000 cycles. Total distortion .5% or less at 10 watts. Less than 2% at 20 watts. Elements can be separated 5 to 25 feet with only .1 db loss at 20 kc. All inputs (3 phono, 1 mike, 2 radio) connect directly to the main amplifier. For more details, write.

BELL SOUND SYSTEMS, INC.

559 MARION ROAD, COLUMBUS 7, OHIO

Export Office: 4900 EUCLID AVENUE, CLEVELAND 3, OHIO



You Are Invited to Attend the Second Annual

AUDIO FAIR

Sponsored by the

AUDIO engineering society



THE EVENT

of utmost interest and importance to Broadcast Engineers, Recordists, Sound-on-Film Men, Public Address Operators, Audio Hobbyists, Dealers and Distributors, and lovers of high-quality music reproduction

SEE and HEAR

industry-wide displays and demonstrations of the latest and best audio equipment, components, and accessories

UNDER ONE ROOF

REGISTRATION FREE

Hotel New Yorker, New York City, October 26-27-28, 1950

ANNUAL CONVENTION BANQUET

Thursday Evening, October 26, 7:30 p.m.

For further information, write

Fair Manager, Room 920, 342 Madison Avenue, New York 17, N. Y.

pair of amplifiers amplifying the signals going in opposite directions. However, there is a device which will feed the signal from line to amplifier in one direction and from amplifier to the same line in the opposite direction and which prevents feedback singing. This is the hybrid coil, Fig. 3.

The requirements of a two-wire repeater in general are:

1. The use of one-way amplifiers designed to provide the necessary gain required to overcome line losses.
2. The use of special hybrid circuits for converting two-wire circuits into four-wire circuits.

3. The use of proper balancing networks for closely approximating the impedance of the line and associated apparatus.

4. The use of filters for eliminating any energy outside the frequency range necessary for good quality voice transmission.

5. The use of miscellaneous apparatus and circuits for adapting the telephone repeater to standard operating practices. Power, testing, signalling, equalization, regulation, and maintenance considerations are included here.

Among the important features of repeaters are bypass circuits that permit d.c. and the 20-cps, 135-cps, and 1000-cps signalling voltages as well as the 3.5-cps dial pulses to be transmitted. The block

diagram, Fig. 4, shows the features of the Type 47 VF repeater as described in the article.

The *International Projectionist* for June 1950 carries an important note on the development of an Electrical Analog for the Mechanism of Hearing by staff members of Bell Telephone Laboratories. The analog corresponds to the physiological structure (described by Goodfriend in *Æ* p. 22, May, 1949 and consists of a 175 section transmission line of lumped parameters. Each series resonant shunt section corresponds to a section of the basilar membrane. The range of resonant frequencies is from 17,000 to 500 cps. The voltages along the line, which are available at jacks, correspond to the motion along the basi-

Now Available!

audio anthology

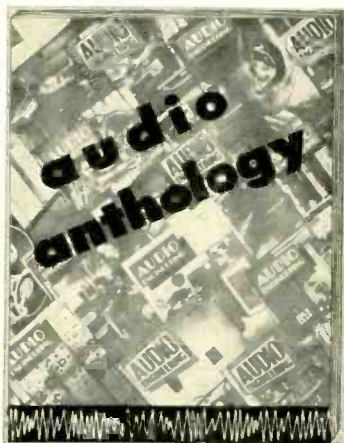

Paper cover . . . \$2.00

Board cover . . . \$3.00

Distributors write for quantity discount

The long awaited compilation of reprints from early issues of **AUDIO ENGINEERING**, most of which are unobtainable.

Contains 37 articles on the following subjects:

- Amplifiers
- Speakers
- Noise Suppressors
- Phonograph Equipment
- Tone and Loudness Controls
- Dividing Networks

These articles have been of great interest to readers of **AUDIO ENGINEERING** over the past three years. Assembled in one volume, they comprise the most authoritative reference work for the audio hobbyist.

-----CUT OUT-----MAIL TODAY-----

Book Division, Dept. A9
Radio Magazines, Inc.
342 Madison Ave., New York 17, N. Y.

Sirs: Enclosed is my check money order for _____ copies of the Audio Anthology.

(Please check one) Paper cover Board cover

Name (print carefully)

Address

City Zone State

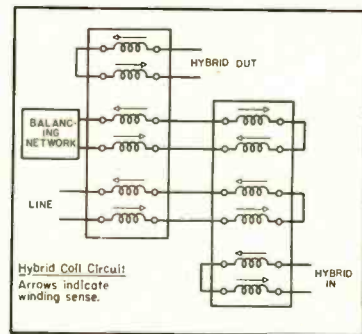

Figure 4

lar membrane. Measurements made on the line show reasonably good agreement with observations on the cochlea.

Flying Mammal Sonar

Bats' use of ultrasonic "echolocation," a form of sonar, is carefully documented in a paper appearing in *The Journal of the Acoustical Society of America*, March 1950. "Measurements of the Ultrasonic Cries of Bats" by Donald R. Griffin details the history of the study of bat cries and obstacle avoidance and then continues with a series of oscilloscope photographs showing the nature of the ultrasonic sounds emitted by bats. These sounds have a frequency range from 31 to 120 kc for the little brown bat, and vary in intensity from 95 to 118 db (referred to 0.0002 dynes/cm²) within 10 cm of the bat. The energy is concentrated in a forward direction and has a duration of less than 2 milliseconds. The pulses appear to be frequency modulated starting at a high frequency and going down about one octave during the pulse. The rate at which the pulses of ultrasonic energy is emitted vary from 20 to 60 per second. A brief description of the audible cries of the bats indicates that the energy lies in the region from 7 to 15 kc but usually near the lower end of this region, but is not used for guidance.

AUDIANA

[from page 36]

or open box the dimensions across the face may often have to exceed six feet.

The mathematics of the reflexed box limit its study at this time because of lack

by the reduction of effort and time in handling complex systems.

REFERENCES

Harry F. Olson: "Dynamical Analogies," New York: D. Van Nostrand Co. Inc., 1943, and "Elements of Acoustical Engineering," 1947.

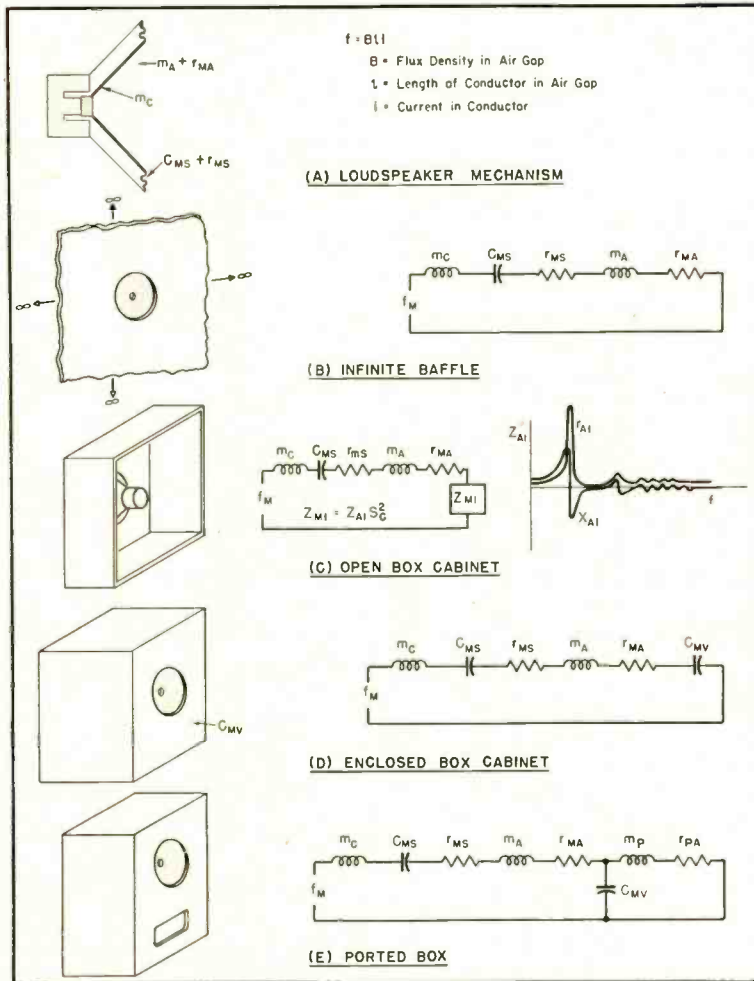

Figure 3

of space. However, with it the range of a speaker may be extended and accentuated in the low-frequency region. The analogous electrical circuit is given at E in Fig. 3.

The use of dynamical analogies in the study of electro-acoustical systems facilitates rapid analysis of the problem, and from the discussion presented it may be seen that the use of the analogies is limited only by the ability of the engineer to adapt his thinking. It is granted that to initiate a change in methods is always difficult, but anyone now using other methods who adopts analogies as a tool for analysis will later be rewarded

OPERADIO ACQUIRES SOUND SLIDE-FILM PATENT RIGHTS

Operadio Mfg. Co., St. Charles, Ill., has recently acquired from Bendix Aviation Corporation exclusive rights together with sublicensing rights under the group of Jenkins and Adair patents. These patents relate to present-day automatic sound slide systems controlled by signals on either record or tape.

Stephens Tru-Sonic Microphone Systems



lapel



stand



swivel

No pre-amplifier required at head

The Stephens Tru-

Sonic Microphone is the only microphone on the market today utilizing the advantages of the condenser type diaphragm in a circuit which does not require a vacuum tube mounted adjacent to the head. With Tru-Sonic Microphone systems, all auxiliary equipment can be used up to 400 feet away from the head, connected only by a small (5/32" diameter) standard single conductor microphone cable carrying no high currents and voltages to feed critical low level circuits.

Stephens Tru-Sonic Microphones are essentially non-directional throughout the entire audio range, have high sensitivity, exceptionally high output level and are extremely small in size. In short, they represent today's highest achievement in microphone design and performance. Available in three models: lapel, stand and swivel.

Write for Bulletin M-1

See us at The Audio Fair
 Hotel New Yorker, Oct. 26, 27, 28.

STEPHENS **TRU-SONIC**
 MANUFACTURING CORPORATION
 8538 Warner Drive, Culver City, California

Air-Tone HEADQUARTERS FOR Magnecord.



McIntosh Amplifiers

Highest quality, efficiency. Full dynamic range. Frequency range—20 to 20,000 plus or minus .2db; 10 to 200,000 plus or minus 2db. Lowest phase shift distortion, lowest noise level.

- 50 W-1 for less than 1% distortion
 - Continuous single frequency rating
 - 50 watts RMS—Peak 100 \$249.50 net
- 20 W-2 for less than 1% distortion
 - Continuous single frequency rating
 - 20 watts RMS—Peak 40 \$149.50 net

AIR-TONE HEADQUARTERS FOR MAGNECORD

Air-Tone offers Magnecord recording equipment for all those who desire the ultimate in Magnetic recording. Easy operating, Magnecord provides unusually high fidelity, great flexibility in use, outstanding realism in tone.

PT6-JA Recorder & Amplifier

Portable rig for professional, superb reproduction of all types of program material. 10-Watts output. Highest Quality, Greatest Value. \$548.00



Air-Tone SOUND & RECORDING COMPANY
 1527 CHESTNUT ST., PHILA. 2, PA. — RI. 6-8388

World-Wide Popularity

Since the inception of AUDIO ENGINEERING in May 1947, engineers and audio hobbyists have subscribed in ever-increasing numbers, not only in the 48 states and in all of the major foreign countries but in such places as Tasmania, Transvaal and Trinidad.

Each month AUDIO ENGINEERING covers the latest developments and practices in recording, reproduction and instrumentation for the entire audio field.

Subscribe Now—Don't Miss an Issue! Back numbers are hard to get!

AUDIO ENGINEERING
 342 Madison Avenue, New York 17, N. Y.

Sirs: Here is my check (or money order) for \$..... Enter my subscription order to AUDIO ENGINEERING for the next issues. Subscription Price: In U.S.A., Canada and Pan American Union—12 issues \$3—24 issues \$5. All others \$4.00 per year. Please check one: New Subscription Renewal.

Name (please print)

Address

City Zone State

Occupation (give title and department)

Firm Name

NEW LOUDSPEAKER

[from page 23]

somewhat below the 600-cps crossover frequency. The mouth area is several times that of some designs aimed at a low crossover frequency. Due to the limited operating range prescribed, the large horn mouth size is still consistent with good polar behavior up to 4000 cps.

Many intricate problems were posed by the projected design of a tweeter to operate at frequencies approaching 20,000 cps. The smaller excursions required by the relatively high frequency band covered by this unit make it possible to utilize a light moving system and small clearances. In the G-610 the tweeter diaphragm assembly utilizes a light but stiff phenolic diaphragm driven by a one-inch aluminum voice coil, with moving system dynamic mass of 130 milligrams. Here again, a high-energy magnet structure is used, furnishing an airgap flux density of 15,500 gauss. Sound chamber clearance, while relatively small, greatly exceeds the peak diaphragm excursion occurring when the loudspeaker is operated at maximum rating. This small clearance required special design considerations. Commercial tolerances for mouldings and die-castings did not offer the extreme accuracy of contour and clearances required, necessitating precision machining for final contouring. As a consequence of these design features, excellent performance of the tweeter is assured to at least 18,000 cps, at which point sound pressure response is down only 3 db from the 60-400 cps average level of the system.

For smooth performance, the mouth size of the Hypex high-frequency horn was chosen as 1½ inches so that its size is somewhat greater than one-third of a wavelength at the lowest frequency in the passband of the unit. This small mouth size, combined with the appropriate Hypex-formula flare, produce excellent spatial distribution. The over-all response does not vary appreciably over extremely wide listening angles. The circular mouth configuration achieves an identical spatial distribution in both horizontal and vertical planes. Optimum placement and streamlining of the unique tweeter assembly minimize obstacle effect and maintain a smooth response over the entire operating range of the loudspeaker.

All electrical crossover and response control elements are contained in a separate chassis with connecting cable to plug into the loudspeaker. Conventional LC crossover networks employ high-Q air-core inductors to avoid introduction of distortion inherent in iron

cores. While iron cores have a permeability subject to variation with power level and frequency, the permeability of air is constant, thereby allowing no non-linear distortion effects. Through use of generous sized components, total insertion loss of the network has been held to a maximum of 0.3 db. Incorporated internally in the network is a three-step level adjustment for controlling the middle- and high-frequency response of the G-610. This optional adjustment was found desirable following many subjective tests in various rooms to allow for compensation of room size and absorption characteristics affecting these regions. Coupled to the network are two external controls. An L-pad over-all volume adjustment supplies individual loudspeaker control in multiple installations. A four-position high-frequency cutoff control permits graduated restriction of the high-frequency response to a lower limit of 4000 cps to match the requirements of the source material.

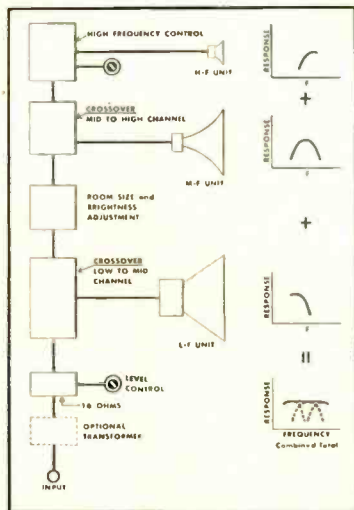

Fig. 3. Schematic of three-way crossover and control system, Model G-610 Triaxial.

Distortions and noise which may be present in associated equipment and source material can be minimized as required. While input impedance is 16 ohms, provision is made on the network chassis for plug-in connection of transformers to match amplifier impedances of other values. Electrical arrangement is shown in Fig. 3.

Subjective Realism

Objective measurements have clearly shown that the G-610 combines the widest range, lowest distortion, and best efficiency of any loudspeaker system available commercially. This unit takes its place as one of the strongest links in the audio reproduction chain, as adjudged by its smooth, balanced response,

NEVER BEFORE . . .

A Continuously Variable-Speed Turntable of Broadcast Quality



Model CVS-12P

Model CVS-12



PLAYS AT ANY SPEED FROM 25 TO 100 R.P.M. WITHOUT "WOW"!

Features REK-O-KUT'S Exclusive VARI-CON DRIVE*

*Patent Pending

REK-O-KUT, with a premier position in the quality recording field, now brings a continuously variable-speed turntable within the reach of everybody.

PARTIAL LIST OF APPLICATIONS

- Disc Jockeys** . . . can regulate timing of transcriptions, etc.
- TV-AM-FM Broadcast Stations** . . . for sound effects, rehearsing, etc.
- Schools—Teaching** . . . languages, typing, music appreciation.
- Dance Studios—Teach Faster** . . . rhumbas, square dancing, polkas, etc. . . . rhythms and steps are more easily taught when tempo is slowed.
- Skating Rinks** . . . slow or increase tempo of dance records.
- Musicians—Singers** . . . play or sing with any recording—adjust record speed to your own pitch.
- Record Collectors** . . . play records at best sounding speed.
- Gymnasiums** . . . reduce or increase tempo of exercise records.

SPECIFICATIONS

- Speeds can be regulated by a simple movement of the lever to compensate for any fluctuations in line voltage or frequencies.
- Speed Changes** . . . Continuously Variable. (A) . . . 110V-60 Cycles, Range: 25 to 100 R.P.M. (B) . . . 110V-50 Cycles, Range: 20 to 85 R.P.M.
- Turntable** . . . 12" cast aluminum, with hardened and ground shaft.
- Motor** . . . constant speed, 4 pole, with cone pulley.
- Drive** . . . VARI-CON self-seating rim drive.
- Noise Level** . . . —30db maximum below average recording level.
- Dimensions** . . . 16" long, 12" wide. 1½" above chassis. 4" below chassis.
- Model CVS-12—Chassis, Motor, and Turntable** . . . net **\$84.95**
- Model CVS-12P—Mounted in Portable Case with 16" Pickup.**
(Plays through your radio or TV set) . . . net **\$124.95**

Sold by Leading Music Stores, Radio Parts Distributors and Audio-Visual Dealers. Write for full descriptive literature.

REK-O-KUT CO., Inc.
38-01 QUEENS BOULEVARD LONG ISLAND CITY 1, N. Y.

Building Block Design!

Successors to the famous 140 series amplifiers, the new ALTEC 1400 series is the most versatile amplifying, preamplifying, mixing group ever designed. Building block design permits combinations to provide 2 to 12 mixing input channels—preamplifiers that can be mounted on the power amplifier chassis or externally—mixing controls that can be mounted remotely from all other apparatus—output at line level, when required, or 35 to 75 watts. Thorough mechanical and electronic design and outstanding quality make the new ALTEC 1400 series perfect for every speech input and public address requirement.

1161 N. VINE ST., HOLLYWOOD 38, CALIF.
161 SIXTH AVE., NEW YORK 13, NEW YORK

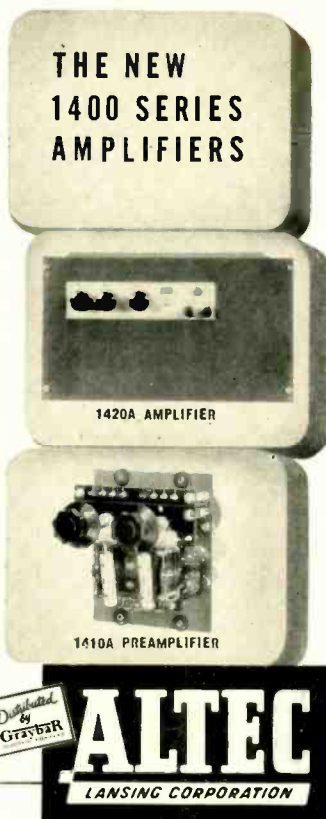

uniform polar pattern, and clean-cut transient response. But what of the subjective performance of such a system?

Extensive listening tests by engineers, musicians and untrained listeners selected at random have been relied upon to evaluate this most important aspect, and to point the way to useful conclusions. Source materials selected were representative of all types of program material, ranging from live studio orchestral and choral groups and sound effects to AM broadcasts and shellac records. Microphones used on recording and on live direct pickups were new high-quality dynamic and condenser types. Amplifying equipment included the new extreme range, low-distortion types as well as more conventional "20-20,000" types. Comparisons were made on blindfold test basis with all the most generally accepted commercial loudspeakers intended for wide-range response.

The unmistakable conclusion coming from a long series of listening tests is that the G-610 makes available a new type of reproduction which creates a vast, vastly higher standard of meaning for the term "high fidelity."

Listeners are fascinated by the overtone detail of instruments adding to the illusion of listener presence at the original performance, and by the striking naturalness of background sounds. The untrained listener, who up to this time had shied away from "high fidelity" as having somewhat screechy, thin, raucous tendencies, is particularly impressed by hearing music which so closely simulates the original.

Much of the definition and detail identifying and characterizing voice and musical instruments are contained in the extreme frequencies. These are reproduced by the G-610 at considerably higher levels than is the case with ordinary loudspeakers. An outstanding characteristic of this unit is its increased "resolving power," which makes each orchestral instrument stand out in its own right. The hard, initial hammer-attack transients of the piano, and the delicate timbre and shadings of the voice are conveyed with unsurpassed clarity. The swishes, rattles, and shimmering sounds of the "noisemaker" instruments—gourd and triangle—are present in lifelike individuality.

Listening at high volume levels is a new experience with the G-610, for it can be "opened up" without accompanying listener fatigue or discomfort. A commentary on the high conversion efficiency of this unit is the small power required to cover large auditoriums with sound. As an example, in a preview demonstration of the G-610 before 200 persons in a well-treated room of 82,000

NEED BACK ISSUES?

*Only a few are available and
the supply is limited*

- | | |
|---|--|
| <input type="checkbox"/> August 1948 | <input type="checkbox"/> January 1950 |
| <input type="checkbox"/> September 1948 | <input type="checkbox"/> February 1950 |
| <input type="checkbox"/> June 1949 | <input type="checkbox"/> March 1950 |
| <input type="checkbox"/> September 1949 | <input type="checkbox"/> June 1950 |
| <input type="checkbox"/> November 1949 | <input type="checkbox"/> July 1950 |
| <input type="checkbox"/> December 1949 | <input type="checkbox"/> August 1950 |

PRICES

1948, 1949	1950
50¢ each	35¢ each

Payment must accompany order.

Circulation Dept., Audio Engineering, 342 Madison Ave., New York 17, N.Y.

cubic feet, the maximum average input powers used were on the order of 3 to 4 watts.

From its tremendous, clean dynamic range to its smooth, realistic duplication of the source, the Triaxial has achieved what we like to call "transport to the original."

AUDIO PATENTS

[from page 12]

its output feeds another voltage divider. The audio signal appearing at the rectifier input may resemble (A) in Fig. 3, which is what the low-level triodes receive. The output of the full-wave rectifier, however, contains both negative and positive peaks, all on the same (negative) side of the baseline, as at

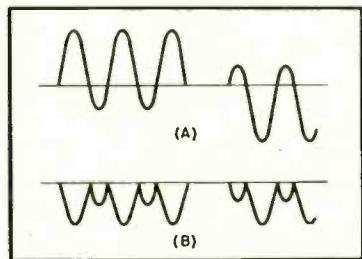

Figure 3

(B). The signal fed to the triodes handling the signals of -4db and above will show how exactly what is happening, and the operator can see a peak of either polarity when it comes along.

The diagram shows only six neon-control triodes for the sake of simplicity. Seven more must, of course, be included in a practical system to drive the additional lamps shown.

At one time very fast db meters were tried out by a number of organizations, but operators objected to the eyestrain involved in following a fast-flickering needle. In addition, there was only very poor indication of average level, which is important, too. A practical adaptation of the system in this patent might include the neon arrangement, with a standard VU meter as well. Properly arranged lights would not be likely to bother the eyes in the same way as a flickering needle and the modern VU meter is especially designed ballistically to show average level.

A copy of any patent may be obtained for 25¢ from the Commissioner of Patents, Washington 25, D. C.

BOONTON RADIO CORP. ELECTS OFFICERS

Boonton Radio Corporation announces the following changes in management, effective Sept. 1, 1950: W. D. Loughlin has been elected Chairman of the Board of Directors; Dr. G. A. Downsborough, President; and Dr. D. M. Hill, Vice-President in Charge of Research and Development.

America's most advanced Tape Recorder

the MAGNEMASTER

Professional
Consolette

Featuring

- Two-speed two-direction operation
50 to 15,000 cycles at 15 in. per sec.
50 to 10,000 cycles at 7 1/2 in. per sec.
- Dynamic range guaranteed better than 50 db.
- Single or dual track recording without changing heads.
- Simultaneous monitoring off the tape while recording (optional)

Other MAGNEMASTER® Features Include:

Separate heads for erase, record and monitor • Guaranteed lifetime head alignment • Choice of two 2-speed models (15 and 7 1/2 inch; or 7 1/2 and 3 3/4 inch) • Shuttle speed in both directions • Synchronized brakes for instantaneous stop • No overshoot or tape spillage during play or shuttle • Flutter ± 0.05% at 15 in. per sec.; ± 0.1% at 7 1/2 in. per sec. • Lifetime self-adjusting spring clutches • Positive 100% erasure.

1937 First magnetic recording amplifier

1947 First commercial dual-channel recorder (20,000 Twin-Trax mechanisms now in operation)

... and now!

First
Professional
Consolette

Magnemaster® Model 815

Available direct from factory at \$395

Low impedance inputs and input mixing facilities optionally available.

All operating controls within span of your two hands.



New designs in amplifier construction to improve response and increase dynamic range; new mechanical principles developed for a more efficient, trouble-free transport mechanism; and new materials designed for us by leading industrial laboratories! These all add up to a tape recorder that's the latest, most advanced recorder ever.

Yes, literally years ahead of its time, because designs now hailed as "modern" by newcomers in the tape recorder field have long since been tried and improved by our engineers, whose continuous association with magnetic recording dates back to 1937. The Magnemaster contains every design feature developed thru these years.

Write today for your copy of our complete technical catalog. See how the Magnemaster stands above all other recorders in its price class. Then compare Magnemaster specifications with console-type recorders at 3 and 4 times its price. You'll do as all other careful buyers are doing—ordering the Magnemaster Consolette.

*Trade Mark Reg.

AMPLIFIER CORP. of AMERICA
398-4 Broadway, New York 13, N. Y.

FREE Send for ALLIED'S NEW 1951 CATALOG!

- ELECTRONIC SUPPLIES for INDUSTRY
- BROADCAST STATION SUPPLIES

World's Largest Stocks • Complete Expert Service from One Central Supply House

Simplify your purchasing problems—send your consolidated orders to ALLIED—the single, complete source for all electronic supplies. Rely on ALLIED for the world's largest stocks of parts, tubes, test instruments, audio equipment, accessories—complete quality lines of electronic supplies ready for immediate shipment from stock. ALLIED'S expert Industrial and Broadcast Station supply service saves you time, effort and money. Send today for your FREE copy of the 1951 ALLIED Catalog—the only complete guide to electronic supplies for industrial and broadcast station applications.

ALLIED RADIO CORP.

833 W. Jackson Blvd., Dept. 17-J-C • Chicago 7, Illinois

Everything in Electronics from ONE Source



212 PAGES: Equipment for Research, Development, Maintenance and Production Operations

Send for
1951
ALLIED
CATALOG

DID YOU KNOW...



Checking a stylus on the Shadowgraph in Sun Radio's Sound Studio -- a free service.

You Can Have Your Phono Stylus Checked

in seconds!

See for yourself the amount of wear on your phono stylus. Just bring it into our audio department where we've installed a shadowgraph that shows the outline of your stylus enlarged 500 times! Our Audio Specialists will also show you how to compare perfect and worn stylii... all without obligation, of course.

This is merely one of the many "SUN ONLY" features you can see at the Sun Audio Studio. If you're a hi-fi enthusiast, come in and look around -- you'll find it worthwhile. For complete high-fidelity music service, components and assemblies, there's no place like SUN.

See Us At The Audio Fair... Room 601

The finest exhibit we've ever had -- even better than last year's. Room 601, Hotel New Yorker, Oct. 26, 27, and 28th. See what's new in high-fidelity music reproduction. Pick up a copy of the new edition of our famous Audio Catalog -- now 100 pages.



NEW LITERATURE

● Audak Company, 500 Fifth Ave., New York 18, N. Y. has recently published a new illustrated catalog containing full description and prices of the entire line of Audak audio components, including reproducers, tone arms, cutters, and equalizers. Copy may be obtained by writing direct to the manufacturer.

● Cornell-Dubiller Electric Corporation, South Plainfield, N. J. announces publication of Catalog No. 410 on its Powercon line of vibrator converters. In addition to equipment listings, the 32-page booklet contains a vibrator selection guide, in the form of a table for quick reference.

● Insulation Manufacturers Corporation, 565 W. Washington Blvd., Chicago 6, Ill. announces that Insulation Items, an 8-page publication issued every month, will be continued indefinitely. Copy of the free booklet, which covers a variety of electrical insulation subjects, may be obtained by writing to the address shown above.

● Measurements Corporation, Boonton, N. J. has just issued the second in the series of Measurements Notes. Subject of the paper is "Measurement of Receiver Impulse Noise Susceptibility."

● Standard Transformer Corporation, 3580 Elston Ave., Chicago 18, Ill. announces publication of a new edition of the Stancor catalog of transformers and related components for radio, sound and industrial applications. The 20-page illustrated booklet may be obtained direct from Stancor or from any of its distributors.

● United Transformer Company, 150 Varick St., New York 13, N. Y. is now distributing Catalog 500, a 28-page illustrated booklet listing the full UTC line of transformers, reactors and filters. Also included is a variety of amplifier circuits, curves and useful charts. Copy will be supplied without charge upon request.

● Superior Electric Company, Bristol, Conn. is now distributing Bulletin 749, a 12-page booklet describing the 1950 line of Powerstat light dimming equipment. Along with descriptions of the equipment, several pages are devoted to suggested uses ranging from TV studios to church applications. Copy may be obtained free by writing.

● Magnetic Recording Tape. A new tape designed to meet the requirements of every type of user and produced by specialists in plastics and precision coating with more than a quarter century of experience has just been introduced. The new tape, Hifitone, is made to exacting sound and durability standards with smooth red oxide coatings of high cohesive force, and is available with either paper or plastic base, reeled with coated side in or out as required. 150, 600, and 1200-foot spools are supplied normally on plastic reels, or on metal reels when specified. Further technical data may be obtained from Duplitech Laboratories, 1770 W. Berteau Ave., Chicago 13, Ill.

● Rek-O-Kut Company, Inc., 38-01 Queens Blvd., Long Island City 1, N. Y., offers without charge its new catalog of hi-fidelity recording and transcription equipment. The catalog is liberally illustrated and contains complete price information.

PROFESSIONAL DIRECTORY

C. J. LeBEL

AUDIO CONSULTANT

Sound Recording • Instrumentation

370 RIVERSIDE DRIVE
NEW YORK 25, N. Y.

Custom-Built Equipment

U. S. Recording Co.

1121 Vermont Ave., Washington 5, D. C.

STERling 3626

Consultation • Design • Fabrication

Audio Facilities Corporation

133 West 14th Street,

New York 11, N. Y.

HERMAN LEWIS GORDON

Registered Patent Attorney

Patent Investigations and Opinions

Warner Building 100 Normandy Drive
Washington 4, D. C. Silver Spring, Md.
National 2487 Shepherd 2433

RICHARD H. DORF AUDIO CONSULTANT

Sound Systems Recording Installations
Product Design Technical Literature

255 W. 84th Street Phone
New York 24, N. Y. Schuyler 4-1928

AUDIO ENGINEERING SCHOOL

Practical engineering training in Audio fundamentals, Disc, Film, Magnetic Recording, and Audio frequency measurements.

Studio training simulates Broadcast, Motion Pictures, Television, and Commercial Recording work.

Approved for Veterans

Hollywood Sound Institute, Inc.
1040-A North Kenmore, Hollywood 27, Calif.

Specify if Veteran or Non-Veteran

NEW PRODUCTS

● **Portable Phonograph.** Remarkable fidelity of reproduction is claimed for "The Recitalist," a new three-speed portable phonograph recently introduced by the Rex-O-Kut Company, Inc., 38-13 Queens Blvd., Long Island City, N. Y.



Well suited for use in schools, studios, advertising agencies and small auditoriums, the Recitalist contains a microphone input and permits mixing of live voice or music with recordings. Turntable is made of machined aluminum. Sixteen-inch tone arm contains dual-stylus cartridge. Dimensions of the unit when closed for carrying are 17 x 9½ x 21¼ in. and weight is 38 pounds. Descriptive material is available from the manufacturer.

● **FM-TV Sweep Generator.** Although portable and designed essentially for servicing FM and TV receivers, Sylvania's new Type 500 generator offers a range of performance and control normally expected only of laboratory instruments. Four output bands are provided, permitting fundamental output frequencies ranging from 2 to 230 megacycles. Sweep range for FM is 0 to 600 kc, and for TV



is 0 to 15 mc. Adequate drive for all servicing operations is assured by 100-millivolt output on all bands, with attenuator providing continuous control. Double shielding prevents signal leakage and built-in regulated power supply assures frequency stability. Internal voltage is supplied for driving or synchronizing horizontal scope deflection, and wide-range phasing control permits adjustment for single scope-response curve. Type 500 is designed to operate from

standard line voltage, consumes 30 watts, and measures 11½" x 8¾" x 7". Full technical data may be obtained from Radio Tube Division, Sylvania Electric Products, Inc., 500 Fifth Avenue, New York 18, N. Y.

● **FM Relay Receiver.** The REL Model 722 receiver is a rack-mounted single-frequency crystal-controlled double i.f. superheterodyne designed essentially for regional FM networks, but equally adaptable to any application calling for exceptionally fine performance. Distortion is less than 0.5 per cent over a frequency range of 50 to 15,000 cps, sensitivity noise factor is better than 6 db, and sputter point is less than 2 microvolts. Normally supplied for the 88-to-108 mc band, Model 722 may be modified for operation on any frequency from 40 to 216 mc. Technical

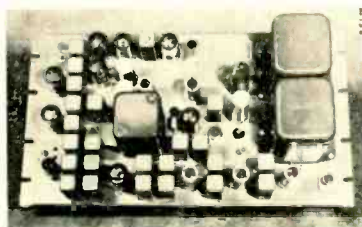

data may be obtained from Radio Engineering Laboratories, Inc., 35-54 36th St., Long Island City, N. Y.

● **Improved VoltOhmyst.** RCA's announcement of the Senior VoltOhmyst brings to the service field an electronic voltmeter capable of direct peak-to-peak measurement of complex waveforms up to 1400 volts. Designed especially for television signal tracing, the new unit permits the measurement of sync pulses, composite wave shapes, and deflection voltages in television receivers without time-consuming computations. Peak-to-peak values are read directly from scale. Designated Type WV-97A, the Senior VoltOhmyst provides seven d.c. ranges, seven a.c. ranges, seven peak-to-peak ranges, and seven resistance ranges. Resistance

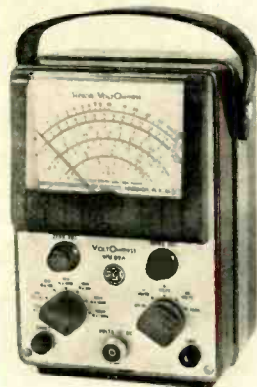

values from 0.1 ohm to 1000 megohms may be read with only 1.5 volts applied to the circuit under test.

A lightweight and versatile instrument,

BRIERLEY RIBBON PICKUP
20 c/s to 40 kc/s on shellac 78's; 20 c/s to 120 kc/s on LP; 2 gram tracking
and
THREE-SPEED 12" TRANSCRIPTION TURNTABLE CHASSIS
Send for details of these specialized products accepted as the finest quality equipment in Britain.
We Will Send Direct
JB/P/R/3 RIBBON PICKUP COMPLETE WITH TRANSFORMER \$38
THREE-SPEED 12" TRANSCRIPTION TURNTABLE CHASSIS \$75
addressee to pay 33.1/3% duty
"REPRODUCTION OF RECORDS-1"
A booklet giving full practical information on building and assembling correctly equipped for use with low output high fidelity pickups.
Sent airmail for \$1.
Write to Dept. AE
J. H. BRIERLEY, LTD.,
(GRAMOPHONES & RECORDINGS)
46, Tithebarn Street, Liverpool, England



HOW LEADING NETWORKS USE Carter CONVERTERS

Photo above shows NBC's Tommy Bartlett and Universal Recording Company engineers making transcriptions from STORAGE BATTERY POWER by means of Carter Frequency Controlled Converter.

Wherever 115v. line voltage is not available, or hard to get, Carter Converters supply dependable AC power to make on location recordings. Operates from storage batteries. Used by leading networks, broadcast stations, and program producers.

Recommended by Brush and Magnecord

One model operates both Brush and Magnecord equipment. Delivers clean 60 cycle AC power. Requires no filtering. Frequency control feature compensates for 10% input voltage variation. Available for 6, 12, 24, 28, 32, 44, and 115v. DC input voltage. Size 8½" x 5½" x 7½" high. Weight only 15¾ lbs. Performance Guaranteed!

MAIL COUPON FOR FREE CATALOG

New Converter catalog illustrates entire line of Carter Rotary Converters for recording, TV, sound collection and transcription players.
SELECTOR CHART included tells model to suit your purpose. Mail Coupon now for your copy and name of nearest Carter distributor.



Carter

MOTOR CO.

2648 N. MAPLEWOOD AVE., CHICAGO 47

Carter Motor Co.
2648 N. Maplewood Ave.,
Chicago 47, Ill.

Please send catalog #349 with information on Frequency Control Converters, and name of nearest distributor.

Name

Station or

Company

Address

MILO SOUND

has all the best lines!

Take your choice of the world leaders in audio equipment. Here's just a partial list—from MILO SOUND'S great warehouse of complete stocks:

ALTEC	LIVINGSTON
APPROVED	MASCO
ASTATIC	MEISSNER
ATLAS	MINNESOTA
AUDAK	MINING
AUDIO DEVICES	NEWCOMB
BELL	PENTRON
BOCEN	PERMOFLUX
BROOK	PICKERING
BROWNING	PRESTO
BRUSH	RACON
CLARKSFAN	RADIO
COLLINS AUDIO	CRAFTSMEN
ELECTRONIC	RAULAND
WORKSHOP	REK-O-KUT
ELECTRO-VOICE	SCOTT
ESPEY	SHURE
GARRARD	SOMERSET
GE	STEPHENS
GRAY	TURNER
HOLL	UNIVERSITY
JENSEN	UTC
LEAK	VM
	WEBSTER

Visit our Showroom.

See us at the AUDIO FAIR.



TWO BOOKS FOR THE AUDIO ENTHUSIAST

Mr. G. A. Briggs, the founder of Wharfedale Wireless Works of Bradford, Yorkshire, England and a leading British authority on sound reproduction, has written two of the most entertaining books on the subject. Readers will enjoy the touches of humour which fall from this writer's pen, and will appreciate the mass of information these books contain.

"LOUDSPEAKERS"

3rd Edition 4th impression

A popular volume which embodies the "Why and How of Good Reproduction" and deals with the entire subject from A to Z. Written in non-technical terms, this little book is acknowledged to be the most comprehensive and comprehensible work on Loudspeakers available today.

88 pages 36 illustrations \$1.25

"SOUND REPRODUCTION"

Second Edition, 248 pages, 193 diagrams

Greatly enlarged, this latest edition is right up to date and contains ten new chapters on such a wide range of subjects as: Exponential Horns and Multiple Speakers; Cabinet Lining; Tape Recordings; Air Loading; Cross-over Networks; Directional Effects; Magnetic Recordings; Ribbon Speakers; Needle Inspection; Sapphire, Tungsten and Diamond. Bound full lexine. \$2.25

Sold through the usual trade channels or from:

BRITISH INDUSTRIES CORPORATION
164 Duane Street, New York 13, N. Y.

the WV-97A is provided with three cables, a d.c. probe, and a slip-on alligator clip. Available accessories include a slip-on crystal probe for u-h-f measurements, a high voltage probe, and a multiplier resistor.

● **Corner Speaker.** Latest entrant into the field of speakers designed for corner installation is the Model 802-C two-way speaker system now available from Holl

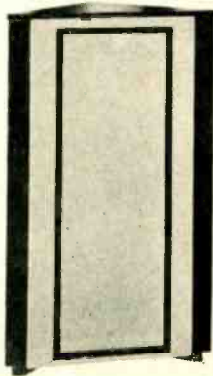

Audio Industries, Hollywood 28, Calif. The 802-C makes use of a 15-in. woofer with 2-in. voice coil, and cross-over frequency is 800 cps. The area of the cone, the air column, and the port are approximately equal so that maximum loading is obtained. Size of the cabinet is 50 in. high x 28 in. wide x 16 in. deep. Power rating is 20 watts. Effective design and corner-type construction make possible an efficient bass horn calling for a minimum of floor space.

● **P.A. Amplifiers.** New and distinctive styling is featured in the "Green Gem" line of amplifiers recently introduced by Rauland-Borg Corporation, 3523 Addison

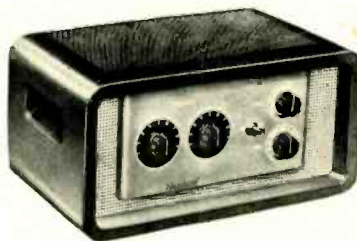

St., Chicago 18, Ill. First of the new line to be released is Model 1916 with 16-watt rated output at five per cent or less harmonic distortion. Two high-impedance microphone inputs and one phono input are provided, with mixing controls on all three. Frequency response is 40 to 20,000 cps ± 1 db. Complete technical specifications covering the entire Green Gem line may be obtained from the manufacturer.

● **Reversible Motor.** Manufacturers of equipment making use of small, reversible motors will find interest in the new DYAB tandem motor recently put into production by Barber-Colman Company, Rockford, Ill. Specifications include maximum output of 0.004 or 0.006 hp, shaded-pole design, stainless steel shaft, and molded

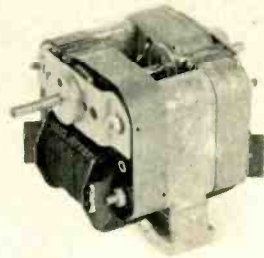

plastic moisture-proof spool. According to the manufacturer the new unit is especially well suited for wire recorders, measuring instruments, remote-tuning transmitters and similar applications.

● **Tape Recording Head.** Claimed by the manufacturer to be the only tape recording head in the industry engineered for mass production, the new TR5 head now being produced by Shure Brothers Inc., 225 W. Huron St., Chicago, Ill. combines the functions of record, erase and playback in a single unit. Unique design assures production control of gap dimension and alignment. Hum is minimized through use of a mu-metal shield. Ease of as-



sembly in equipment and excellent performance characteristics combine to make the TR5 head of unusual interest to manufacturers.

● **Variable Electronic Filter.** Although designed essentially for application in the movie, radio, television, and recording fields, the new Model 300 electronic filter recently announced by Spencer-Kennedy is an ideal research instrument for noise analysis or acoustic measurement in laboratory and industry. Frequency range of the filter is 20 cps to 200 kc with continuously variable cutoff and an attenuation rate of 18 db per octave. A range

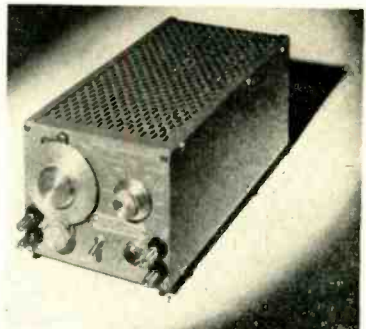

switch selects the type of section desired—high-pass or low-pass—as well as four decade frequency ranges. Full information may be obtained by writing Spencer-Kennedy Laboratories, Inc., 186 Massachusetts Ave., Cambridge 39, Mass.

● **Crystal Microphone.** Remarkable front-to-back ratio is stressed by the manufacturer in announcing the new



Synbar Model DR-10 microphone. Uni-directional cardloid type, the DR-10 makes use of a special sintered metal to virtually cancel out rear pickup. Frequency response is 50 to 10,000 cps, with a switch provided to vary characteristics for voice or music pickup. High impedance output level is -54 db. Manufacturer is Astatic Corporation, Conneaut, Ohio.

● **Plastic Tape.** Formerly sold only to the professional trades. Dutch Brand Plastix tape is now available through retailers in convenient 150-ft. rolls. Because



it is exceedingly thin, has 200 per cent stretch and high dielectric resistance, Plastix tape is well suited for splices

where space is limited. Further information may be obtained from Van Cleef Bros. Inc., 7800 Woodlawn Ave., Chicago 19, Ill.

● **DC-AC Chopper.** Longer life and lower noise level, together with decrease in size and weight, are all featured in the new Type 268 DC-AC chopper recently placed in production by Stevens-Arnold. Frequency range of the new model is 10 to 500 cps for all commercial purposes; tests now in progress indicate that operation as high as 800 cps may be commercially feasible. Average ratings are 10 volts at 1 ma d.c., although both these values may be exceeded on an intermittent basis. The entire unit is hermetically sealed and fits a standard 8-pin octal

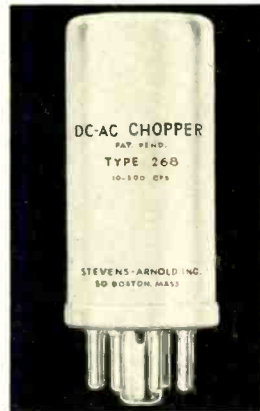

base. Technical description will be supplied free by the manufacturer, Stevens-Arnold, Inc., 22 Elkins street, South Boston 27, Mass.

● **Finger Wrench.** "Touch 'N' Grip" is the name appropriately applied to a small wrench for placing, holding and tighten-

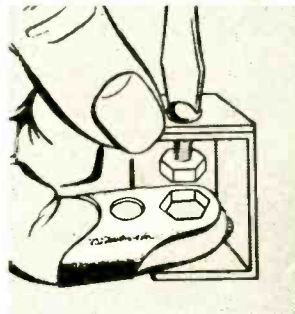

ing nuts in out-of-the-way or out-of-sight locations in electronic or electrical equipment. Also, the wrench minimizes the need for picking up and putting down tools, since it is worn like a thumb and does not limit the use of the hands. Manufacturer is F. E. Redfield Company, 31 Colonial Parkway, Dumont, N. J.

● **Control Track Generator.** A boon to the TV and sound-on-film fields is this new device which makes possible the use of many standard magnetic-tape recorders for picture-synchronous sound-track recording, and which is available for immediate delivery from Fairchild Recording Equipment Corporation, White-

ATLAS "Multi-Cellular" TWEETER

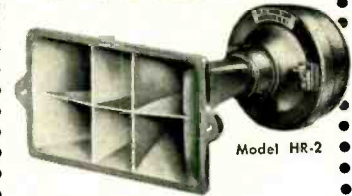

SIX CELL, WIDE ANGLE
DISTRIBUTION: 100° x 50°
Clean and efficient to 15,000 cycles
25 watts of program material above 1000 cycles

"Alnico-V-Plus" super efficient magnetic circuit. Heavy die cast sectoral horn, flush mounting 6 3/4" wide, 3 1/2" high, 8" deep. A new high in realism—smooth and clean musical brilliance. Perfect articulation and Sibilance in voice reproduction.

Variable High Pass Filter
Model FN-1



WRITE FOR COMPLETE DESCRIPTIVE CATALOGUE

ATLAS SOUND CORPORATION
1448 39th St. Bkn. 18, N. Y.

GOOD NEWS FOR TAPE RECORDISTS

ELEMENTS of SINGLE and DUAL TRACK TAPE RECORDING and 1001 APPLICATIONS

A. C. Shoney's NEW BOOK

This 112 page reference book used by recording technicians, experimenters, and recordists has been unanimously acclaimed tops. Over 100 illustrations, circuit diagrams, construction hints plus the latest theories and designs. Send \$1.00 postpaid for your copy.

To: Amplifier Corp. of America
398-4 Broadway, N. Y. C.
 Rush... copies of A. C. Shoney's Book "Elements" I enclose herewith \$..... @ \$1 per copy.
 Rush free literature on your complete tape recorder line.
NAME _____
ADDRESS _____
CITY _____ STATE _____

AMPLIFIER CORP. of AMERICA
398-4 Broadway, New York 13, N. Y.

ADDRESS CHANGES—

Subscribers to AUDIO ENGINEERING should notify our Circulation Dept. at least 5 weeks in advance regarding any change in address. The Post Office Dept. does not forward magazines sent to a wrong destination unless you pay additional postage. We can NOT duplicate copies sent to your old residence. Old and new addresses MUST be given.

AUDIO ENGINEERING
RADIO MAGAZINES, INC.

342 Madison Ave.
New York 17, N. Y.

CLASSIFIED

Rates: 10¢ per word per insertion for noncommercial advertisements; 25¢ per word for commercial advertisements. Rates are net, and no discounts will be allowed. Copy must be accompanied by remittance in full, and must reach the New York office by the first of the month preceding the date of issue.

Equipment

FOR SALE: Presto 90-A Amplifier, three mike inputs, 30-15,000 cps, \$250; Brush three-hour wire recorder with extras, \$195 (orig. cost \$800); sell both as unit \$395. 2 Presto 1-D heads, \$60 each. 2 transcription arms, \$8 each. Presto AM tuner and FM Pilotuner \$50. Reco-Art Sound Recording Co., 1305 Market St., Philadelphia 7, Pa.

FOR SALE: University dual tweeters, \$16; network \$4. Bogen 10-watt amplifier, \$19. GE S1201-D speaker, \$12. Bozak dual tweeters, \$12. Livingston Universal arm, \$10. GE 810 speaker \$3. R. D. Balzer, 435 E. 74th St., New York 21, N. Y.

FOR SALE: Presto 6N, 1-C cutter, 87A amplifier, Rek-O-Kut G-2 turntable, Turner U9S, Shure 55C, stands, cables, cases, \$450. Box CP-1, AUDIO ENGINEERING.

Records

FOR SALE: Victor albums M-935, Swarthout, \$2.50; DM-740 Brahms-Horowitz, \$4.50; M-358, Gershwin, \$1.50; DM-1224, Handel, \$2; AM-509, Rimsky-Korsakov, \$4.50; Decca firr EDA-16, Dukas, \$2.25. All in fine condition, used only with diamond stylus. F.O.B. New York, Box CS-4, AUDIO ENGINEERING.

ELECTRONICS TECHNICIANS WANTED

The RCA Service Company, Inc., a Radio Corporation of America subsidiary, needs qualified electronics technicians for U. S. and overseas assignments. Candidates must be of good character and qualified in the installation or maintenance of RADAR or COMMUNICATIONS equipment or TELEVISION receivers. No age limits, but must have at least three years of practical experience.

RCA Service Company offers comprehensive Company-paid hospitalization, accident and life insurance programs; paid vacations and holidays; periodic review for salary increases; and opportunity to obtain permanent position in our national and international service organization, engaged in the installation and maintenance of AM, FM and TV transmitters, electronic inspection devices, electron microscopes, theatre and home television, r-f heating equipment, mobile and microwave communications systems, and similar electronic equipment.

Base pay, overseas bonus, payments for actual living and other expenses, and benefits mentioned above add up to \$7,000 per year to start for overseas assignments, with periodic review of base salary thereafter. Openings also available at proportionately higher salaries for specially qualified technicians with supervisory ability.

Qualified technicians seeking an advantageous connection with a well-established company, having a broad-based, permanent peacetime and wartime service program, write to

Mr. G. H. Metz,
Personnel Manager,
RCA Service Company, Inc.,
Camden 2, New Jersey



stone, N. Y. In operation the control track generator superimposes a high-frequency signal on the magnetic tape simultaneously with the sound track. This signal becomes the tape speed control during playback. When played back on a Fairchild Pic-Sync recorder the control track compensates for tape stretch and shrinkage, maintaining lip-sync between the sound track on the tape and the picture on the film. No extra heads or modifications to presently owned tape recorders are required. Full technical specifications are available from the manufacturer.

● **Corner Speaker.** Corner horn loading is combined with direct radiation in a new speaker system designed by Klipsch and Associates, Hope, Arkansas. Design-



nated the Rebel, the new unit is said to offer exceptionally smooth response and low intermodulation. Although designed by the makers of the famous Klipschorn, it is substantially lower in price. Available in a variety of finishes including walnut, oak, mahogany, and enamel on unfigured hardwood. Full details will be supplied without charge by the manufacturer.

● **Sweep and Marker Generator.** Overall alignment of TV receivers as well as alignment of front ends is facilitated by the Marka-Sweep, recently introduced to the trade by Kay Electric Company, Maple Ave., Pine Brook, N. J. Available



AS ONE MAN SAID TO ANOTHER

Dear Sirs:

A short time ago a friend of mine in Massachusetts purchased one of your transformers. His enthusiasm knew no bounds so I am sending you an International Money Order on this date for one of these transformers. I might add that I am looking forward to doing business with you after the recommendation that I have received.

Sincerely yours,

New Model Type 2B3B. Pri. 10,000 v. a. t.; Incremental Ind. over 100 H. Sec. Z: 1.25, 2.8, 5, 7.8, 11.3, 15.3, and 20 H. Leakage reactance under 15 mh. Size: 5 1/2" x 4" x 6". P.C. 4 3/4" x 3 3/4". Weight: 12 lbs. Price \$12.00 post free, duty extra.

SAVAGE TRANSFORMERS LTD.,
Devises, Wilts, England.

SAVAGE TRANSFORMERS LTD. DEVICES

Ready NOW ULTRASONIC FUNDAMENTALS

By S. YOUNG WHITE

The rapid increase in the use of ultrasonics during the last few years makes it natural that the well-informed sound engineer should want to learn something of the applications and potentialities of this amazing new field. But interest in ultrasonics is not confined to the sound engineer—it is of still greater importance to the industrial engineer for he is the one who will visualize its uses in his own processes.

Elementary in character, ULTRASONIC FUNDAMENTALS was written originally as a series of magazine articles just for the purpose of acquainting the novice in this field with the enormous possibilities of a new tool for industry. It serves the double purpose of introducing ultrasonics to both sound and industrial engineers. The list of chapter headings will indicate how it can help you.

CHAPTER HEADLINES

Too Much Audio. Opportunities in Ultrasonics. Elements of Ultrasonics. Experimental Ultrasonics. Coupling Ultrasonic Energy to a Load. Ultrasonics in Liquids. Ultrasonics in Solids. Testing by Ultrasonics. High-Power Ultrasonics. Notes on Using High-Power Ultrasonics. Applications of Ultrasonics to Biology. Economics of Industrial Ultrasonics.

The applications of ultrasonics have already extended to many industries, and as its possibilities are explored they will increase a hundredfold. To keep abreast of its growth, engineers in all fields must know what they may expect from ultrasonics, how it is used, how the energy is generated, and the techniques of applying ultrasonic treatment to many processes.

ULTRASONIC FUNDAMENTALS is not a big book—it does not cover the entire field of ultrasonics with hundreds of pages of dull reading. But in the three hours it will take you to read it, you will get a down-to-earth glimpse into the far-reaching possibilities of a new art.

ULTRASONIC FUNDAMENTALS

By S. YOUNG WHITE

36 pages, 40 ill., 8 1/2 x 11, paper cover \$1.75

Book Division, Dept. A
RADIO MAGAZINES, INC.
342 Madison Avenue New York 17, N. Y.

FROM BELOW
40 TO OVER
15,000 cps
in
ONE UNIT



The time for good sound is here. Long evenings with your favorite radio, television or recorded music call for action NOW to make sure all is ready. That is why we come back to tell you about BARKER NATURAL SOUND, for we believe you will get so much more enduring pleasure, so many more moments of pure satisfaction from our speakers. As a New York studio expert wrote us after nine months with a 150, "I'm still constantly delighted with it." And he has access to the finest loudspeaker systems made. The BARKER drive and cone form a sound source which not only covers a greater audio frequency range in one smooth sweep than that given by most twin units but is from lowest bass to topmost harmonics controlled by the critical self generated feed-back within its own central core, the aluminum former. No other speaker can have this exclusive, patented, all-important feature. It ensures a decisive, clean beginning and end to all transients, low or high; a swift death to all sub-harmonics; an almost complete wipe out of resonances, including the usual major cone "bump". That is why BARKER quality is so NATURAL and good to the most critical ears.

Another letter, just in from Philadelphia, says: "I find your statements regarding the speaker fully justified by its excellent performance." At their delivered-to-you prices, BARKER speakers are the best really good speaker value obtainable. Two models, both full size 12in. frames, with 14,000 or 17,500 gauss field strength. Prices \$45 or \$60 by post to your home. Write NOW to:

BARKER NATURAL SOUND REPRODUCERS
BCM/AADU, LONDON, W.C.1., ENGLAND.

More Pleasure...for Less



MUSIC LOVERS
AMPLIFIER
\$29.50

Especially designed by CONCORD engineers to give the Hi-Fi Fan an inexpensive yet good quality unit. Normal rated output 8 watts (harmonic distortion only 2%). Three inputs for magnetic, and crystal cartridges, and radio tuner; built-in pre-amp for reluctance pickups; separate bass and treble controls with flat position---bass gives 10db boost, treble gives 12db boost and 14db attenuation. Freq. resp. at rated output 40-15,000 cps \pm 1db. Tubes: (2)6V6, 6SL7, 6SC7, and 6X5 rect. For 117V, 60 cycle AC. Brown hammerloid finish. Size: 10-1/2 x 6 x 5-1/4". With tubes.

2-295A -- Shpg. wt. 10 lbs. 29.50

ATTENTION HI-FI CUSTOM INSTALLERS

Write on business letterhead for information on Concord's Dealer Plan and Technical Advisory Service designed especially for custom installation men. Write now for FREE information.

CONCORD RADIO CORP.

Mall Order Center and Showroom
901 West Jackson Blvd. Chicago 7, Ill.

CONCORD RADIO CORP. Dept AK50
901 W. Jackson Blvd., Chicago 7, Ill.

Enclosed \$.... (include shipping charge.
Any excess will be refunded.)

Rush ___ Music Lovers Amplifiers @ \$29.50

Send FREE latest Bargain Bulletin

Name.....

Address.....

City..... Zone..... State.....

In two models differing only in the type of marker employed, the Marka-Sweep employs a 12-position channel switch which selects extremely narrow crystal-positioned picture and sound carrier markers as well as the usual 15-mc sweep oscillator output. All carriers are oscillator fundamentals. The Marka-Sweep is entirely electronic in operation. Use of a regulated power supply together with the all-electronic sweep generator assures a high degree of operating stability.

● Isolation Transformer. Of equal interest to service men and testing laboratories is the new 350-watt isolation trans-



former now being manufactured by Standard Transformer Corporation, 3580 Elston Ave., Chicago, Ill. In addition to providing isolation, the unit may be used to correct for either high or low line voltage, three standard receptacles affording 105, 115, and 125 v.a.c. output from 117-volt input.

● Communications Recorder. Departing in many respects from the conventional magnetic recorder, the Audiolog makes use of a thin, flexible, reusable sleeve of magnetic material upon which a full hour of speech or code can be recorded. In operation, the magnetic recording sleeve is slipped over an internally-driven rotating drum. Separate recording and play-back heads move laterally across the drum, so arranged that any recorded portion can be played back while recording is in progress. Both heads are equipped with inexpensive pole pieces which can be quickly replaced when worn. The recording head contains an advance magnet which automatically erases previously recorded material when sleeves are being re-used. The flexible sleeves can be telescoped so that a 24-hour log can be filed as a compact unit. Complete information may be obtained from Audiolog Corporation, 440 Peralta Ave., San Leandro, Calif.



Coming to

THE AUDIO FAIR ?

Oct. 26, 27, 28

A
TIME-TESTED
DEPENDABLE
SOURCE
FOR

HIGH-PRECISION FRACTIONAL
H.P. INSTRUMENT-TYPE
MOTORS & GENERATORS
PRODUCED TO ORDER

GOVERNOR-CONTROLLED
SELF-SYNCHRONOUS
DRAG CUP
VELOCITY & ACCELERATION
DC & AC TACHOMETER
SHUNT
SERIES
COMPOUND
PERMANENT MAGNET
SPLIT-FIELD
SEPARATELY EXCITED
UNIVERSAL
INDUCTION
RELUCTANCE
MYSTERESIS
ONE, TWO & THREE PHASE
DC & AC SERVO
TOTALLY ENCLOSED
AC DYNAMICALLY BRAKED
REEL MOTORS
ONE, TWO, THREE & FIVE SPEED
SYNCHRONOUS MOTORS

Experienced for years in meeting customers' exacting requirements for high-precision instruments designed by engineers of ability and ingenuity, and manufactured with extreme care and skill. Over 500 different basic types may be varied to meet your own unique requirements of use, either electrically or physically.

ELECTRIC INDICATOR CO.

PARKER AVENUE
STAMFORD, CONNECTICUT

"HAVE YOU HEARD
THE SOUND OF QUALITY?"



NEWCOMB SOUND IS BETTER

Manufacturers of public address, mobile, photograph, musical instrument and wired music amplifiers • Portable systems • Portable photographs and radios • Transcription players • Rack and panel equipment.

Write today! Circle items of interest and indicate whether you are a Dealer, Paris Jobber or Sound Specialist.

NEWCOMB AUDIO PRODUCTS CO.
DEPT. T, 6824 LEXINGTON AVE.
HOLLYWOOD 38, CALIFORNIA

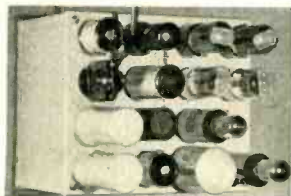

20 W-2 Amplifier \$149.50

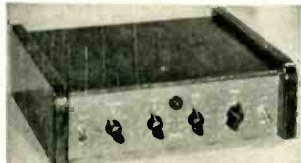

AE-2 Equalizer PreAmp \$74.50



50 W-2 Amplifier \$249.50

McIntosh

Engineering Laboratory, Inc.
910 King St. Silver Spring, Md.
Prices Subject to Change Without Notice.

THE HARTLEY-TURNER STORY

For quite a while now we have been inviting you to send a dollar bill for "New Notes in Radio," data sheets, a high-fidelity report, illustrated literature and so on. What does all this amount to, and what do you get for your dollar?

We quote from two orders received this week, which are typical of the sort of letters we get:

"Some time ago I sent you a dollar bill with a request for New Notes and other literature. I was amazed to see the stack of stuff I got, and it has taken me a while to digest all of it. But now I have, there is very little doubt in my mind that the 215 speaker is THE answer. No other manufacturer of loudspeakers that I have come across has ever presented such a reasonable and correct analysis of the factors involved in loudspeaker design."

"I have received and have read with a great deal of interest the literature you sent me in reply to my request. I can assure you that my dollar was well spent."

We want to make it clear that we do not ask you to spend a dollar to be convinced that you must have a 215 loudspeaker. What we send for your dollar is the knowledge we have acquired in twenty years' specialization in high-fidelity. We give you an absolutely unbiased statement of what we think and why we think it. And it is good sound practical knowledge.

It happens that out of that knowledge we have been able to design and make what a lot of people think is a very good speaker. In the Speakeasy scheme we have been able in design and make work a very good way of marketing it. Both the speaker and the marketing scheme have proved very successful indeed in your country, and we trace the success of both to the fact that each is an honest proposition most likely to appeal to discriminating people.

Why not send that dollar today and find out what it all means?

H. A. HARTLEY Co., Ltd.
152, HAMMERSMITH ROAD,
LONDON, W. 6, ENGLAND

ADVERTISING INDEX

Air-Tone Sound & Recording Co.	62
Allied Radio Corp.	65
Altec Lansing Corp.	1, 64
Amperite Co., Inc.	8
Ampex Electric Corp.	72
Amplifier Corp. of America	65, 69
Arnold Engineering Co., The	3
Arrow Electronics, Inc.	35
Atlas Sound Corp.	69
Audak Co.	39
Audio Devices, Inc.	Cover 2
Audio Facilities Corp.	65
Audio Instrument Co.	44
Barker Sound Reproducers	71
Barker & Williamson	46
Bell Sound Systems, Inc.	59
Bell Telephone Laboratories	14
Bozak, R. T.	58
Brierley, J. H., Ltd.	67
British Industries Corp.	68
Browning Laboratories, Inc.	54
Cannon Electric Development Co.	50
Carter Motor Co.	67
Chicago Transformer Div.	53
Classified	70
Concord Radio	71
Daven Co.	Cover 3
Dorf, Richard H.	65
Duotone Co.	52
Electric Indicator Co.	71
Electro-Voice, Inc.	41
Fairchild Recording Equipment Corp.	55
Fisher Radio Corp.	58
FM-TV Magazine	37
General Radio Co.	9
Gordon, Herman Lewis	65
Gray Research & Development Co., Inc.	42
H. A. Hartley Co., Ltd.	72
Harvey Radio Co., Inc.	45
Heath Co.	33
Hewlett-Packard Co.	7
Hollywood Sound Institute, Inc.	65
Hudson Radio & Television Corp.	57
C. J. LeBel	65
Magrecord, Inc.	2, 43
McIntosh Engineering Laboratory, Inc.	72
Measurements Corp.	13
Milo Radio & Electronics Corp.	68
Newcomb Audio Products Co.	71
Partridge Transformers, Ltd.	72
Permoflux Corp.	6
Pfanstiehl Chemical Co.	12
Pickering & Co., Inc.	11
Presto Recording Corp.	31
Professional Directory	65
Racon Electric Co.	49
Radio Corp. of America	4, 5
RCA Service Company, Inc.	70
Reeves Soundcraft Corp.	47
Rek-O-Kut Co., Inc.	63
Savage Transformers, Ltd.	70
Scott, Inc., Hermon Hosmer	56
Stephens Mfg. Corp.	61
Sun Radio & Electronics Co., Inc.	65
Tech Laboratories, Inc.	48
Terminal Radio Corp.	51
Triad Transformer Mfg. Co.	40
U. S. Recording Co.	66
United Transformer Co.	Cover 4



Partridge Mews

Individually tested
AUDIO TRANSFORMERS
to the 'WILLIAMSON'
Specification

This range of 20 watt push-pull output transformers is intended for use in equipment reproducing the full audio frequency range with the lowest distortion. The design and measured performance is exactly as specified by Williamson in the "Wireless World" August 1949 (see also Audio Engineering November 1949). The transformer is available in a varied range (separate models suitable for KT60, 807 tubes, etc.) Performance assured by comprehensive testing procedure applied to each unit. Close limits set on shunt reactance at 50 cps., series reactance at 5 Kc/sec., d.c. resistances and interwinding insulation resistances at 2 K.V. This is the best possible transformer of its type (weight 1.4 lbs.) Our new technical data sheet is available and will be rushed to you by airmail upon application. The price of the potted model is \$19.50. Postage, packing and insurance \$1.50 extra. We can guarantee immediate despatch.



PARTRIDGE TRANSFORMERS LTD

Roebuck Road, Tolworth, Surrey, England

... highest known
Recording Efficiency
for Instrumentation Applications



Ampex Magnetic Tape Recorders offer the only proved means of making electrically reproducible recordings up to 40,000 cps! Such critical recording permits detailed study of particular phenomena from tape loops, or other automatic data reducing systems. Up to 14 channels of data recorded simultaneously on separate tracks where required. Special systems record down to 0 cycles with no phase shift or wave form distortion. Write for analysis of your specific problem.



Ampex Magnetic Tape Recorders are available in console, rack or portable types.

UNLIMITED USES INCLUDE:

- Recording-Broadcasting
- Industrial Recording
- Laboratory Research
- Telemetry
- Aerophysical Research
- Multi-Channel Recording
- Portable Half-Track Recording

STANDARD OF THE GREAT RADIO SHOWS
AMPEX
MAGNETIC TAPE RECORDERS

AMPEX ELECTRIC CORP.
San Carlos, Calif.

It's that Simple...



... Automatic Push-Button Tuning

An Exclusive Feature of the New

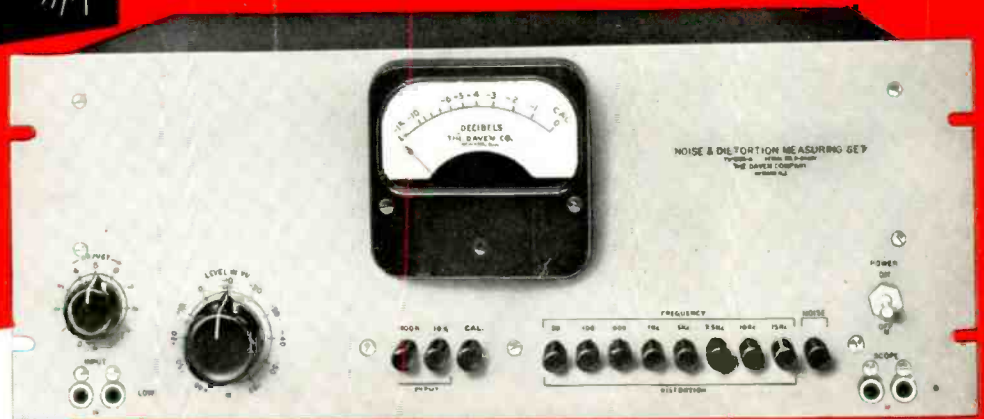

DAVEN

Distortion and Noise Meter Type 35-A

The DAVEN Type 35-A, Distortion and Noise Meter, is a new, skillfully engineered instrument that provides a rapid, accurate means of measuring distortion, noise and hum level in audio frequency equipment.

Of particular importance is the fact that there is no balancing or laborious time consuming tuning required to make measurements. The user need only push a button and the unit is automatically balanced.

This is accomplished by the use of a series of 8 fixed band rejection filters covering the range 50 cycles to 15 K.c., followed by a stable, high quality, wide range (50 cycles to 45 K.c.), high gain amplifier. There are no tube circuits or other sources of inherent distortions, making it possible to measure low levels of distortion accurately over a wide level range.

SPECIFICATIONS

RESIDUAL DISTORTION: No tube circuits or non-linear devices between input of set and filter input.

DISTORTION MEASUREMENTS: Filters provided for 50, 100, 400, 1000 cycles, 5 Kc, 7.5 Kc, 10 Kc, and 15 Kc with cut off of -70 db. Distortion measurements to 0.1% full scale meter deflection with zero level input.

NOISE MEASUREMENTS: With zero db input, limit is -80 db. At +40 input, limit is -115 db below input.

AMPLIFIER FREQUENCY RANGE: 50 cycles to 45 Kc.

ACCURACY: Filters are down 70 db at fundamental frequencies, and within ± 0.5 db of flat response at the second harmonic. Absolute accuracy of measurement can be depended upon to be within $\pm 5\%$.

RESIDUAL NOISE LEVEL: Below -80 db at gain control full on. Multiple gain control employed so that residual noise drops to -90 db. when gain control is set at -30, -100 db when gain control is set at -20, etc.

Write
for
detailed
information

THE **DAVEN** CO.

185 CENTRAL AVENUE
NEWARK 4, N. J.

SEE DAVEN AT THE
AUDIO FAIR, ROOM 616



ULTRA COMPACT UNITS...OUNCER UNITS

HIGH FIDELITY . . . SMALL SIZE . . . FROM STOCK

UTC Ultra compact audio units are small and light in weight, ideally suited to remote amplifier and similar compact equipment. High fidelity is obtainable in all individual units, the frequency response being ± 2 DB from 30 to 20,000 cycles.

True hum balancing coil structure combined with a high conductivity die cast outer case, effects good inductive shielding.



TYPE A CASE
1 1/2" x 1 1/2" x 2" high

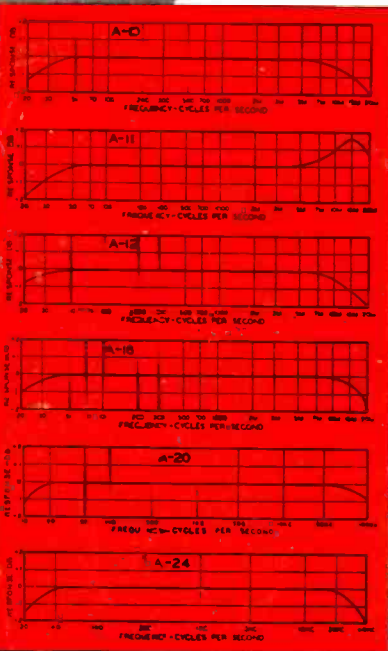

Type No.	Application	Primary Impedance	Secondary Impedance	List Price
A-10	Low impedance mike, pickup, or multiple line to grid	50, 125/150, 200/250, 333, 500/600 ohms	50 ohms	\$15.00
A-11	Low impedance mike, pickup, or line to 1 or 2 grids (multiple alloy shields for low hum pickup)	50, 200, 500	50,000 ohms	16.00
A-12	Low impedance mike, pickup, or multiple line to grids	50, 125/150, 200/250, 333, 500/600 ohms	80,000 ohms overall, in two sections	15.00
A-14	Dynamic microphone to one or two grids	30 ohms	50,000 ohms overall, in two sections	14.00
A-20	Mixing, mike, pickup, or multiple line to line	50, 125/150, 200/250, 333, 500/600 ohms	50, 125/150, 200/250, 333, 500/600 ohms	15.00
A-21	Mixing, low impedance mike, pickup, or line to line (multiple alloy shields for low hum pickup)	50, 200/250, 500/600	50, 200/250, 500/600	16.00
A-16	Single plate to single grid	15,000 ohms	60,000 ohms. 2:1 ratio	13.00
A-17	Single plate to single grid 8 MA unbalanced D.C.	As above	As above	15.00
A-18	Single plate to two grids. Split primary	15,000 ohms	80,000 ohms overall, 2:3:1 turn ratio	14.00
A-19	Single plate to two grids 8 MA unbalanced D.C.	15,000 ohms	80,000 ohms overall, 2:3:1 turn ratio	18.00
A-24	Single plate to multiple line	15,000 ohms	50, 125/150, 200/250, 333, 500/600 ohms	15.00
A-25	Single plate to multiple line 8 MA unbalanced D.C.	15,000 ohms	50, 125/150, 200/250, 333, 500/600 ohms	14.00
A-26	Push pull low level plates to multiple line	30,000 ohms plate to plate	50, 125/150, 200/250, 333, 500/600 ohms	15.00
A-27	Crystal microphone to multiple line	100,000 ohms	50, 125/150, 200/250, 333, 500/600 ohms	15.00
A-30	Audio choke. 250 henrys @ 5 MA 6000 ohms D.C. 65 henrys @ 10 MA 1500 ohms D.C.			10.00
A-32	Filter choke 60 henrys @ 15 MA 2000 ohms D.C. 15 henrys @ 30 MA 500 ohms D.C.			9.00

UTC OUNCER components represent the acme in compact quality transformers. These units, which weigh one ounce, are fully impregnated and sealed in a drawn aluminum housing 1/8" diameter... mounting opposite terminal board. High fidelity characteristics are provided, uniform from 40 to 15,000 cycles, except for 0-14, 0-15, and units carrying DC which are intended for voice frequencies from 150 to 4,000 cycles. Maximum level 0 DB.



JNCER CASE

3/8" dia. x 1 1/8" high

Type No.	Application	Pri. Imp.	Sec. Imp.	List Price
0-1	Mike, pickup or line to 1 grid	50, 200/250, 500/600	50,000	\$13.25
0-2	Mike, pickup or line to 2 grids	50, 200/250, 500/600	50,000	13.25
0-3	Dynamic mike to 1 grid	7.5/30	50,000	12.00
0-4	Single plate to 1 grid	15,000	60,000	10.50
0-5	Plate to grid. D.C. in Pri.	15,000	60,000	10.50
0-6	Single plate to 2 grids	15,000	95,000	12.00
0-7	Plate to 2 grids, D.C. in Pri.	15,000	95,000	12.00
0-8	Single plate to line	15,000	50, 200/250, 500/600	13.25
0-9	Plate to line, D.C. in Pri.	15,000	50, 200/250, 500/600	13.25
0-10	Push pull plates to line	30,000 ohms plate to plate	50, 200/250, 500/600	13.25
0-11	Crystal mike to line	50,000	50, 200/250, 500/600	13.25
0-12	Mixing and matching	50, 200/250	50, 200/250, 500/600	12.00
0-13	Reactor. 300 Hys.—no D.C.; 50 Hys.—3 MA. D.C.,		6000 ohms	9.50
0-14	50:1 mike or line to grid	200	1/2 megohm	13.25
0-15	10:1 single plate to grid	15,000	1 megohm	13.25

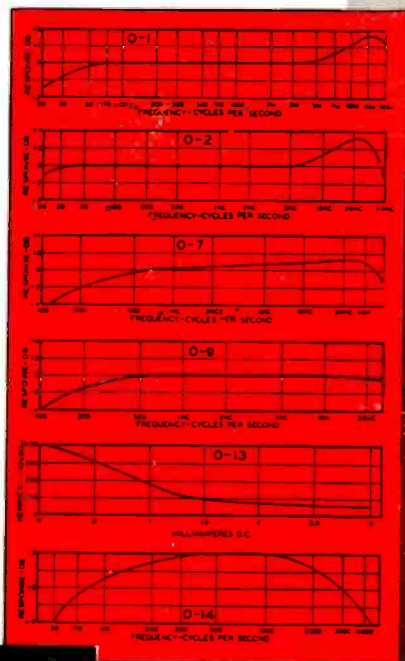

United Transformer Co.
150 VARICK STREET NEW YORK 13, N. Y.
EXPORT DIVISION: 13 EAST 40th STREET, NEW YORK 16, N. Y., CABLES: "ARLAB"