

# AUDIO ENGINEERING

FEBRUARY  
1952  
35c

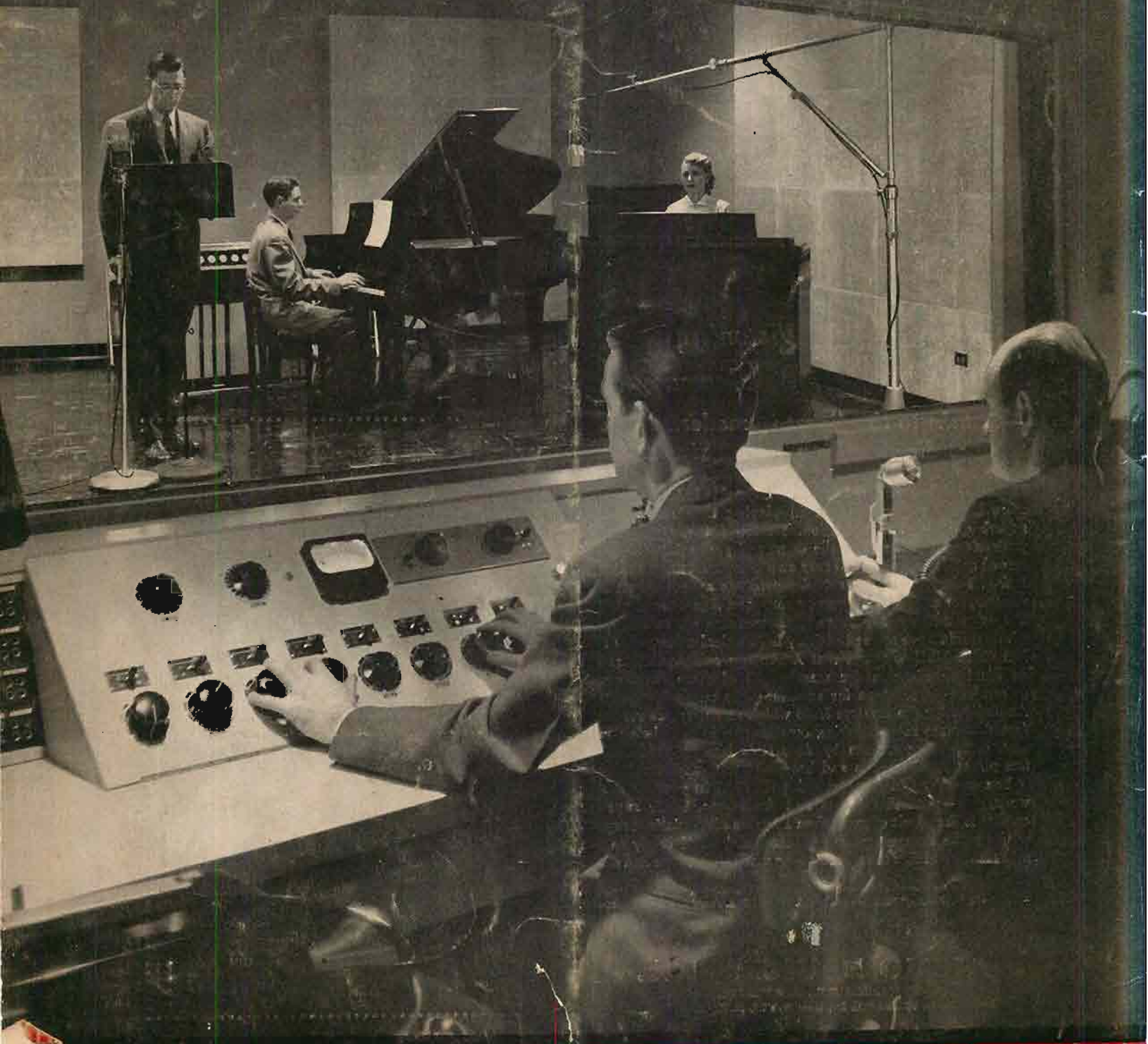

THE WORLD OF SOUND



# columbia **LP** records

mean maximum **L**istening  
**P**leasure

—thanks to the finest in modern sound  
recording methods and equipment

Music lovers everywhere know that Columbia LP records mean more listening pleasure—not in playing time alone, but in superb quality of reproduction. Yet few listeners outside the professional circle realize the degree of perfection which this record quality requires in every step of manufacture and processing. Take the original sound recordings and the processing masters, for example. Frequency response, signal-to-noise ratio, distortion and surface noise must measure up to standards which would have seemed entirely impractical a few years ago. But Columbia has found that Audiotape and Audiodiscs are an ideal combination for meeting all of these exacting requirements—Audiotape for recording the original sound and Audiodiscs for the masters from which stampers are made. In fact this same record-making combination is now being used with outstanding success by America's leading producers of fine phonograph records and broadcast transcriptions.

You can get this same sound perfection in *your* recording work, too—with Audiodiscs and Audiotape. Their superior quality is the result of more than 12 years of specialized experience by the only company in America devoted solely to the manufacture of fine sound recording media, both tape and discs.

©The exclusive trade-mark of Columbia Long Playing Records—symbol of highest quality. Trade-Marks "Columbia," "Masterworks," "LD." Reg. U.S. Pat. Off. Marcas Registradas.

## **AUDIO DEVICES, Inc.**

444 MADISON AVE., NEW YORK 22, N. Y.  
Export Dept.: 13 East 40th St., New York 16, N. Y., Cables "ARLAB"

...including  
**audiotape\***  
for the original sound



...and **audiodiscs\***  
for the master recording



\*Trade Mark

Successor to **RADIO** —Established 1917

# AUDIO ENGINEERING

INCLUDING



**C. G. McProud, Editor** **Ladd Haystead, Publisher**  
 Harrie K. Richardson, Associate Editor  
 Luci Turner, Production Manager S. L. Cahn, Advertising Director  
 Lucille Carty, Circulation Manager H. N. Reizes, Advertising Manager

**Editorial Advisory Board**

Howard A. Chinn  
 John D. Colvin  
 C. J. LeBel  
 J. P. Maxfield  
 George M. Nixon



**Representatives**

H. Thorpe Covington, Special Representative  
 677 N. Michigan Ave., Chicago 11, Ill.  
 Sanford R. Cowan, Mid-West Sales  
 67 W. 44th St., New York 18, N. Y.  
 James C. Galloway, Pacific Coast Sales  
 816 W. 5th St., Los Angeles 17, Calif.  
 Technical Book & Magazine Co.  
 297 Swanston St., Melbourne, C. I.  
 Victoria, Australia

**CONTENTS FEBRUARY, 1952 Vol. 36, No. 2**

Audio Patents—Richard H. Dorf .....	2
Letters .....	6
Editor's Report .....	8
Audiana .....	8
Loudspeaker Damping with Dynamic Negative Feedback—Ulric J. Childs ..	11
The Design of Compensated Volume Controls—Part 2—Emerick Toth .....	14
The Traveling Mike—N. H. Crowhurst .....	16
Linear-Scale A-F Wattmeter—C. G. McProud .....	17
Audio in the Home—William C. Shrader .....	18
Record Revue—Edward Tatnall Canby .....	20
New Products .....	28
New Literature .....	29
Relax and Listen .....	34
<b>AUDIO engineering society SECTION</b>	
AES Notes .....	38
Employment Register .....	38
Book Review .....	39
Industry Notes .....	39
Industry People .....	39
Advertising Index .....	40

**COVER**

A recording session in Studio A of Audio-Video Recording Company, Inc. A complete remodeling of the quarters previously occupied by radio station WQXR has made this plant one of the recording show-places of New York, with facilities for tape and disc recording, mastering, editing, and most other allied services. Photo by Jack Sharin.

**RADIO MAGAZINES, INC., 342 MADISON AVE., NEW YORK 17, N. Y.**

AUDIO ENGINEERING (title registered U. S. Pat. Off.) is published monthly at 10 McGovern Ave., Lancaster, Pa., by Radio Magazines, Inc., D. S. Potts, President; Henry A. Schober, Secretary-Treasurer, Executive and Editorial Offices: 342 Madison Avenue, New York 17, N. Y. Subscription rates—United States, U. S. Possessions and Canada, \$3.00 for 1 year, \$5.00 for 2 years; elsewhere \$4.00 per year. Single copies 35c. Printed in U. S. A. All rights reserved. Entire contents copyright 1951 by Radio Magazines, Inc. Entered as Second Class Matter February 9, 1950 at the Post Office, Lancaster, Pa. under the Act of March 3, 1879.

**AUDIO ENGINEERING • FEBRUARY, 1952**

The **TURNTABLE**  
 is the **HEART**  
 of your  
**HIGH FIDELITY**  
**SYSTEM**

You may own the finest pickup, amplifier and speaker that money can buy...yet you'll get poor reproduction if your TURNTABLE has excessive wow, hum or rumble!

## REK-♥-KUT

... offers a complete range of 12" Turntable models to match your present high-fidelity equipment and your own pocketbook. Not every sound system requires the most expensive turntable...your turntable must be chosen to complement your other components. Each REK-O-KUT Turntable carries an engineering specification which enables your Sound Dealer to select the appropriate unit. The quality and workmanship of every REK-O-KUT Turntable, from our most economically-priced model, to our highest priced professional machine is identical... price differential is dependent solely upon the type of materials used.



**MODEL LP-743**  
**3-Speed 12" Turntable**  
 Induction type motor, designed for smooth, vibration-free operation. Instantaneous speed changes without stopping turntable or removing disc ..... \$54.95 Net



**MODEL CVS-12**  
**All-Speed Continuously-Variable Turntable**  
 Plays all records, 6" to 16" and broadcast transcriptions, not only at the three normal speeds, BUT AT ANY SPEED from 25 to 100 RPM. You play your records at the EXACT SPEED at which they were recorded, or at any variation of speed or pitch which gives you maximum pleasure. A "must" for serious music lovers, pro musicians, schools, dance studios, etc. .... \$84.95 Net

**MODELS T-12H & T-43H**  
**2-Speed 12" Turntables**

The only 12" dual-speed turntables that meet the standards for speed regulation and WOW content specified by the National Association of Broadcasters.



Recommended for use with ULTRA HIGH FIDELITY Amplifiers and Speaker Systems.

MODELS	MOTOR	SPEED	PRICE
T-12 H*	Hysteresis Synchronous	78-33 1/2	\$119.95
T-43 H*	Hysteresis Synchronous	45-33 1/2	\$119.95
T-12	4 Pole Induction	78-33 1/2	\$84.95
T-43	4 Pole Induction	45-33 1/2	\$84.95

\* Delivery limited to very short supply of Hysteresis motors.

See...hear...compare REK-O-KUT Turntables, Phonographs and Professional Disc Recorders at leading Music Stores, Audio-Visual Dealers and Radio Parts Jobbers... or write for latest, free Catalogue.

## REK-O-KUT CO.

38-01 Queens Blvd., Long Island City, N. Y.

EXPORT DIVISION: 458 Broadway, New York City, U. S. A.  
 CANADA: ATLAS RADIO CORP., LTD., 560 King St. W., Toronto 29, Ontario

# TRIAD General Purpose POWER Transformers

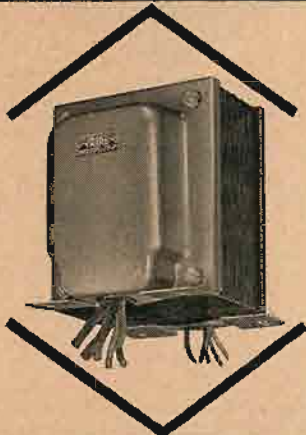

**Tested...to meet  
your requirements  
and excel in  
performance...**

**T**RIAD general purpose Power Transformers are specially designed, not only for replacement, but for use in, electronic equipment for industry, for PA amplifiers, and for amateur gear.

All types are "Climatite" treated, both coil and core, for protection against moisture and for elimination of lamination chatter. Laminations are painted to prevent rust. Although small in size, the high quality materials used in these transformers keep losses to a minimum. Only copper coils for static shields, grounded to case and core, are used. Leads are UL approved for high temperature operation. Final tests include checking for correct operation and stressing in all ways beyond maximum operating potential. Beautifully finished in gray enamel with all specifications on decal on the case.

Remember! Only Triad Transformers are "Climatite" treated

Available from stock at leading jobbers

Write for Catalog  
TR-51

2254 Sepulveda Blvd.  
Los Angeles 64, Calif.



# AUDIO PATENTS

RICHARD H. DORF\*



Fig. 1

**C**ONSTANT MARTIN is a Frenchman whose developments in electronic musical instruments have earned him widespread recognition in Europe. He is not well known in the United States, probably because none of his instruments have been marketed or, to the writer's knowledge, even demonstrated in this country. One of the Constant Martin organs appears in Fig. 1—a two-manual instrument with several separate oscillators per note. These organs are individually voiced by adjusting stop filter com-

ponents at the time of installation to suit them to the auditorium and have the chorus effect so desirable in a good organ and so difficult to attain in an electronic one.

The latest U. S. Martin patent, No. 2,563,477, covers a simple monophonic (one-note-at-a-time) instrument. It has the virtues of simplicity and cheapness and entirely aside from any commercial value the circuit should provide a quick and easy way for those interested to build a useful little solo instrument.

The circuit of the tone-generator section is shown in Fig. 2. It has only three tubes and could easily be condensed to two (or one and a half) by using a 6SN7 for  $V_1$  and  $V_2$ .

The oscillator is the simplest kind of two-tube unit. The output of  $V_1$  is coupled to the grid of  $V_2$ , the plate of which is coupled back to the grid of  $V_1$ . The only capacitor concerned is  $C_1$ ,  $C_2$ , or  $C_3$ , the coupling capacitor between the plate of  $V_1$  and the grid of  $V_2$ . In conjunction with the resistance between the grid of  $V_2$  and ground, it forms an R-C time-constant circuit which determines the frequency of oscillation. For a given value of this resistance,  $C_1$ ,  $C_2$ , or  $C_3$  may be selected to produce differing pitch ranges.

The resistance in the grid circuit of  $V_2$  is divided into several parts and key switches select the amount of the resistance to be grounded and made part of the time-constant circuit, thus selecting pitches. Resistors  $R_1$  should be selected by experiment to give consecutive notes of the chromatic scale with a suitable value for  $C_1$ . Then,

\* 255 West 84th St., New York 24, N. Y.

[Continued on page 4]

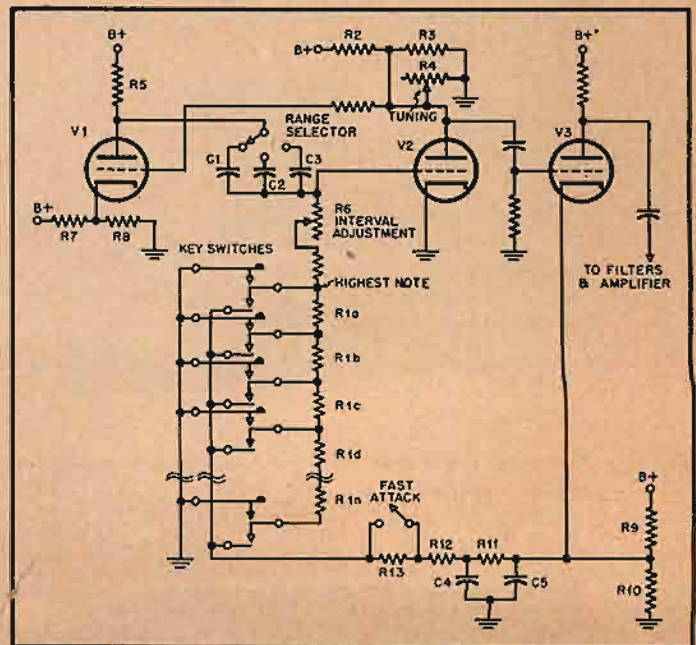

Fig. 2

**REEVES**

# SOUNDCRAFT

THE ONLY MANUFACTURER OF RECORDING MEDIA  
WITH 20 YEARS' EXPERIENCE IN SOUND RECORDING

**ANNOUNCES NEW PRODUCTS . . .**

**NEW DEVELOPMENTS . . .**

**NEW ERA IN MAGNETIC SOUND**

## **NEW** IMPROVED SOUNDCRAFT TAPE

*Only* Souncraft SPN magnetic recording tape with improved formulation has these new exclusive features. Available in all standard sizes.

**UNIFORM COATING THICKNESS** to produce the ultimate in sound fidelity.

**PRE-COATED BASE, BUFFED, SURFACE LUBRICATED** to assure smooth, curl-free operation, uniform output level and high frequency response, plus years of extra service.

## **NEW** SOUNDCRAFT 5 DRAWER CHEST

**PERMANENT FILING CABINETS** — with five drawers, constructed of durable, lined boxboard, containing 625 or 1250 ft. sizes, at no extra cost. Only Souncraft can make this offer.

**BUILD A BETTER TAPE LIBRARY.** Recordings of fine artists, sound effects, memorable events can now be conveniently filed with the aid of this new cabinet.

## **NEW** SOUNDCRAFT DISCS

*Only* Reeves SOUNDCRAFT Recording Discs offer the latest developments to reduce surface noise to the point of inaudibility and produce the last word in fidelity.

**INGREDIENTS OF PERFECTION** Heavy aluminum bases free of imperfections, with flawless mirror-like finish, guaranteed flatness, fine-grain lacquer which has been subjected to micro-filtration and blended with chemically pure solvents.

**FACTORY WITH MAN-MADE WEATHER**

Unlike most discs, Souncraft Discs are manufactured in a weather-controlled factory, under dust-free conditions. Temperature and relative humidity are completely regulated. Souncraft Discs, because of these controlled conditions, are delivered the year 'round.

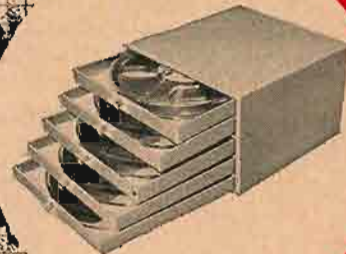

**REEVES**  
**SOUNDCRAFT**

10 East 52nd Street New York 22, N. Y. THE ONLY  
RECORDING MATERIALS PERFECTED  
AND MANUFACTURED  
BY RECORDING SPECIALISTS

Please write Reeves Souncraft for additional information.



# CHICAGO FULL FREQUENCY OUTPUT TRANSFORMERS

## .2db 30-20,000 CPS

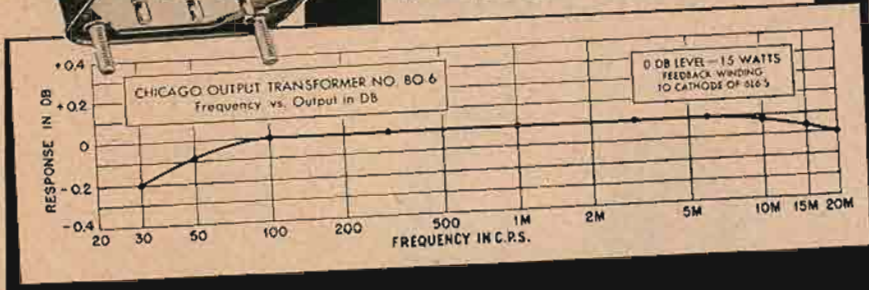

**No. 80-6.** For use in high fidelity amplifiers. Couples push-pull 6L6's (7500 ohms, C-T) to 6/8 or 16/20-ohm voice coil. Center-tapped tertiary winding provides 15% inverse feed-back to reduce harmonic distortion to a minimum. In drawn steel case, 4 5/16" x 3 7/8" x 3 11/16", with mounting studs and convenient pin-type terminals.

**No. 80-7.** For matching 600 or 150-ohm line to a 6/8 or 16/20-ohm voice coil. Frequency response within plus or minus 1db. at full rated output—maximum power level, 30 watts. Mounted in compound-filled drawn steel case, 4 5/16" x 3 7/8" x 3 11/16". Mounting studs and pin-type terminals same as No. 80-6 illustrated above.

There's a CHICAGO Output Transformer for Every Full Frequency Use

Cat. No.	Application	Impedance	Max. Power
BO-1	Single Plate to Line	Pri.—15,000 ohms at 0 to 10 ma d-c *Sec.—600/150 ohms CT	+20 dbm..
BO-2	P.P. Plates to Line	*Pri.—20,000 ohms CT *Sec.—600/150 ohms CT	+30 dbm..
BO-3	P.P. Plates to Line	*Pri.—5,000 ohms CT *Sec.—600/150 ohms CT	+40 dbm..
†BO-4	P.P. Plates to Line	*Pri.—7,500 ohms CT *Sec.—600/150 ohms CT	+43 dbm..
BO-5	P.P. Plates to Line	*Pri.—10,000 ohms CT *Sec.—600/150 ohms CT; 16/8/4 ohms	+37 dbm..

†Tertiary winding provides 15% inverse feedback. \*Split and balanced windings.

### HIGH Q CHOKES

for Dynamic Noise Suppression Circuits

Two precision-built chokes with inductance values of .8 and 2.4 henrys respectively—accurate to within ± 5% with up to 15 ma d-c. Units have a minimum Q of 20. Remarkably compact, 1 1/8" x 2 3/8" x 1 3/8".

No.	Inductance
NSI-1	.8 h
NSI-2	2.4 h

### Famous "Sealed in Steel" New Equipment Line

The units described above are typical of CT's New Equipment Line featuring transformer engineering that's ahead of the trends in circuit design. Get the full facts on the complete line now. Check the features, and you'll see why CT is called the "Engineer's Transformer." Check the prices: see how little more these advanced units cost over ordinary transformers.

Write for Complete "New Equipment" Catalog Today



## CHICAGO TRANSFORMER

DIVISION OF ESSEX WIRE CORPORATION

3501 ADDISON STREET • CHICAGO 18, ILLINOIS

since time-constant is equal to  $R \times C$ , changing to  $C_2$  or  $C_3$  will simply shift the entire chromatic scale to another range without varying the half-tone intervals between keyed notes. One basis for selecting  $C_2$  and  $C_3$  would be to produce tones one and two octaves below or above that of  $C_1$ . Another idea (not mentioned in the patent) might be to provide twelve capacitors on the switch so that the instrument would be an automatic transposer which could be set to play a solo in any key while the player may use his keyboard as though the composition were written in  $C$ , the simplest and most familiar key.

The plate-supply voltages for the oscillator will affect the pitch. Voltage for  $V_1$  is taken directly from the supply through load resistor  $R_3$ , but that for  $V_2$  is taken from a voltage-divider network  $R_1-R_2-R_3$ . To compensate for tube aging and for replacement tubes with slightly different characteristics  $R_1$  is variable and is used for retuning. The first section of the  $V_2$  grid resistance,  $R_4$ , is also made variable so that inter-note intervals can be touched up. This is possible because it is percentage change in grid resistance that determines the intervals and a change in a portion of the resistance will affect all the percentages.

To make it possible to have only one capacitor in the frequency determining circuits the grid of  $V_1$  and the plate of  $V_2$  are direct-coupled. This puts the grid  $V_1$  at a positive potential equal to that of the plate of  $V_2$ . To bring the  $V_1$  grid-cathode potential to the desired point the cathode is placed across a voltage divider  $R_7-R_8$  between B-plus and ground. The output waveform of the oscillator, not mentioned in the patent, is probably roughly sawtooth. It should be possible to control the waveshape to a large extent by choosing suitable values for  $R_7$  and  $R_8$ .

To get rid of clicks and thumps when the instrument is keyed, a simple and effective time-delay circuit is used in the first amplifier stage  $V_3$ . A voltage divider  $R_9-R_{10}$  across the B-supply places the cathode at a positive enough value to cut off plate-current flow. The cathode is connected through  $R_{11}$ ,  $R_{12}$ , and  $R_{13}$  to a second free contact on each key switch so that when the key is pressed the switch first grounds a pitch-determining resistor and then grounds the cathode through its resistors. Capacitors  $C_4$  and  $C_5$  make the network a two-section time-constant filter, so that there is a gradual rather than sudden build-up of plate current when a key switch grounds the cathode through the resistors. Obviously, to obtain much of a delay the resistors must be fairly large, which means that  $R_{10}$  must also be large so that the series value of  $R_{11}-R_{12}-R_{13}$  will be enough of a shunt to lower the bias appreciably. A switch across  $R_{14}$  permits the total resistance of the delay network to be reduced for faster attack when desired.

An additional diagram in the patent shows a complex filter through which the tone may be passed after amplification to obtain a variety of colors. Any other suitable filters, such as those used in the Baldwin Organ, Minshall-Estey Organ, Organo, Sofovox, and similar instruments, could be used. A third diagram shows a vibrato oscillator, but here again any arrangement for varying oscillator plate-supply voltage at about 6 cps will work well.

A copy of this or any other patent may be secured from the Commissioner of Patents, Washington 25, D. C., for 25¢.

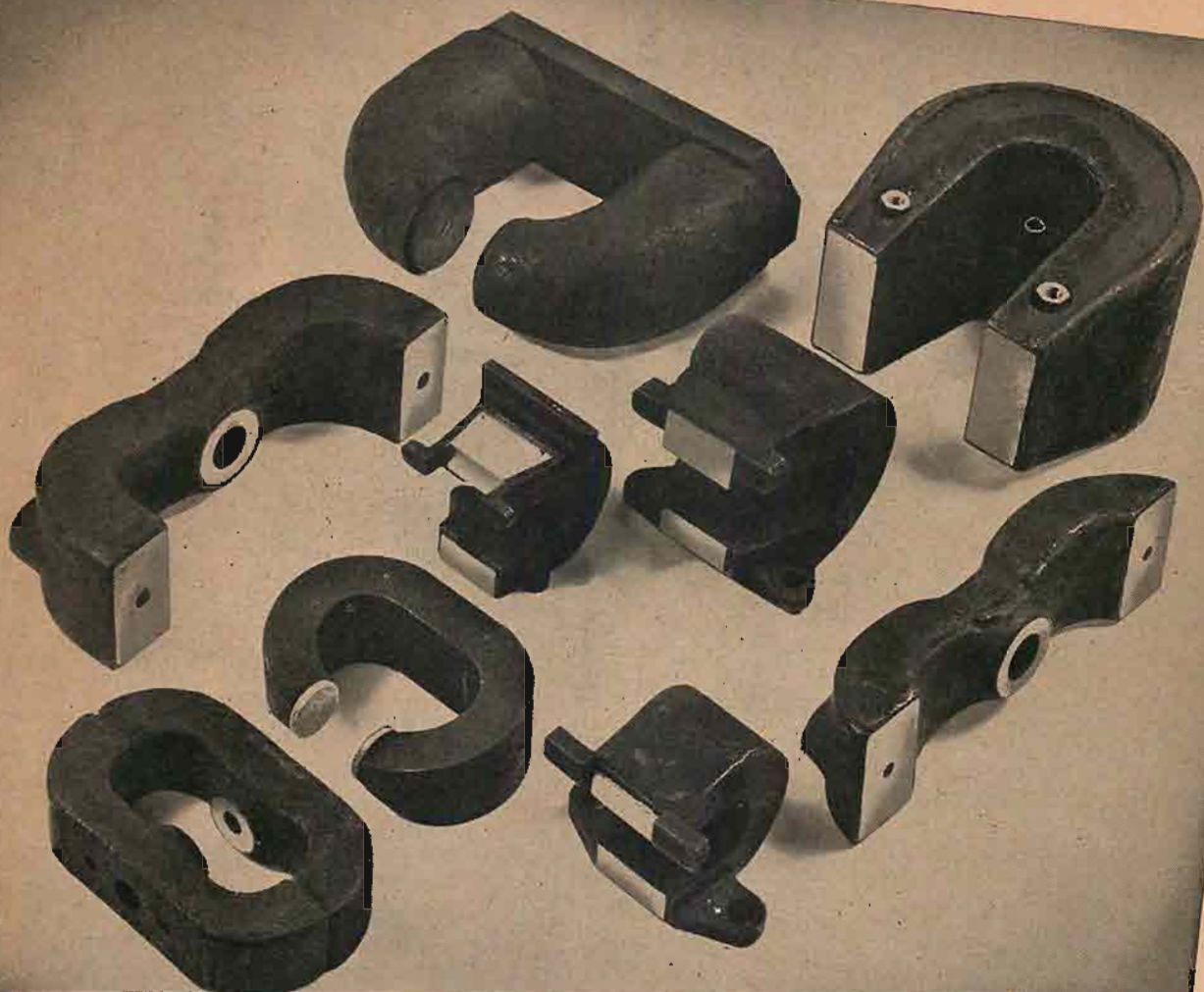

# MAGNETRON PERMANENT MAGNETS AND ASSEMBLIES

- with*
- ☆ Die Cast Aluminum Jackets
  - ☆ Sand Cast Aluminum Jackets
  - ☆ Celastic Covers

Complete assemblies with Permendur, steel or aluminum bases, inserts and keepers as specified. Magnetized and stabilized as required.



**THE ARNOLD ENGINEERING COMPANY**

SUBSIDIARY OF ALLEGHENY LUDLUM STEEL CORPORATION

General Office & Plant: Marengo, Illinois

AUDIO ENGINEERING • FEBRUARY, 1952

# \* MAGNECORDER Sound Performance

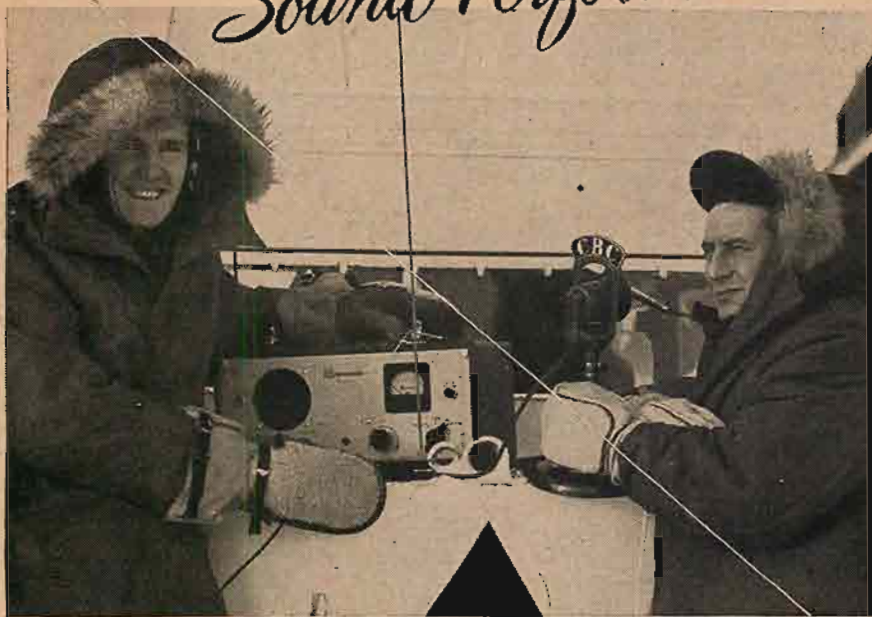

## ...from THE YUKON...TO THE WORLD!\*

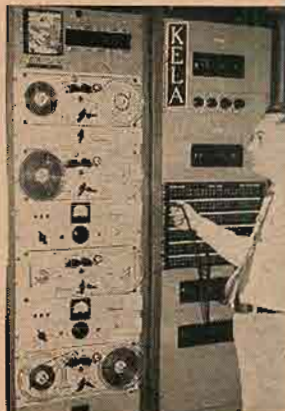

Magnecorder tape recorders penetrated the frozen northland on Exercise Sweetbriar (joint operation of U.S. and Canadian air and land forces). Operating perfectly at 30° below zero, Magnecorder recorders and amplifiers supplied the world with dramatic delayed programs from Alaska and the Yukon.

Stateside radio men also know the dependable performance of Magnecorders. One of the hundreds of stations relying on Magnecorders is KELA, Centralia-Chehalis, Washington, where delayed programs and "on locations" are handled with ease and confidence. Precision and fidelity make Magnecorders the first choice of radio engineers everywhere.

### MORE FEATURES

PT7 accommodates 10 1/2" reels and offers 3 heads, positive timing and pushbutton control. PT7 shown in console is available for portable or rack mount.

### GREATER FLEXIBILITY

In rack or console, or in its really portable cases, the Magnecorder will suit every purpose. PT6 is available with 3 speeds (3 3/4", 7 1/2", 15") if preferred.

### HIGHER FIDELITY

Lifelike tone quality, low distortion, meet N.A.B. standards — and at a moderate price. PT63 shown in rack mount offers 3 heads to erase, record and play back to monitor from the tape while recording.



WRITE FOR NEW CATALOG  
**Magnecord, INC.**

360 North Michigan Avenue  
Chicago 1, Illinois, Dept. A-2

Send me latest catalog of Magnecord equipment.

Name.....  
Address.....  
City..... Zone..... State.....



# LETTERS

## Likes Stereos

Sir:

I was much interested in the two stereo pairs on pages 20 and 21 of the January issue of *AE*. I had little trouble in getting the desired results. It seems to me that such pictures could be used to good advantage in a technical magazine.

R. E. Kerney,  
Alburnett, Iowa

## Aid to Aunt Minnie

Sir:

I ran into the problem of simplified switching the last time (*most recent time?* Ed.) I rebuilt the sound reproduction apparatus in our home. The spouse had just learned to switch from phono to radio when I installed TV on the next switch position, thereby confusing her all over again. I have solved the problem on paper, and hope to soon rebuild again, (*See what we mean?* Ed.) incorporating the switching system described below:

Each program source has its own power switch, and its power plug and output plug are inserted into corresponding receptacles in a junction box having six power receptacles and six audio receptacles. In series with each power receptacle is a low-impedance a.c. relay with two pairs of contacts—one pair to energize the amplifier and another to connect the audio output of the source to the amplifier input. Tone controls are normal to all inputs, being in the input circuit of the amplifier.

As far as I know, I shall have to build the relays myself, as I know of no suitable ones on the market. Also I plan to use a solenoid on each changer—I use three separate ones—to engage the driving mechanism when the motor is turned on.

B. C. Barbee,  
854 S. Fredonia,  
Nacogdoches, Texas

## Another Solution

Sir:

My method of solving Mr. Snively's problem is to control everything from one panel of the control center, with relays being housed in the lower part of the cabinet.

Each unit is switched on and off by a small 10,000-ohm DPST surplus aircraft relay, using d.c. to prevent noise and to keep a.c. circuits out of the preamplifier. The rectifier is on the line all the time, but draws an infinitesimal current through the bleeder. I use a two-wafer switch, with one wafer switching the audio circuits and another energizing the relays, which feed a.c. power to the amplifier through one pair of contacts on each relay, and to the individual input source through the other.

Thus the only operation required is to turn the selector switch from off to the desired program source. After the equipment warms up, the radio—for instance—is tuned at the tuner whose dial is lit, and the gain is controlled at the master loudness control on the control center.

This circuit has been in constant use for three years without any trouble, and it has proven to be very simple for non-technical people to operate.

Fred Paget,  
356 5th Ave.,  
Redwood City, Calif.

(Two solutions—you pay yer money and you takes yer choice. Ed.)





# HUDSON Has Everything To Assure Your Complete HI-FI Satisfaction!

Truly Sensational Value! Exclusive at HUDSON

## audio-pacific

### TRUE HIGH FIDELITY AMPLIFIERS

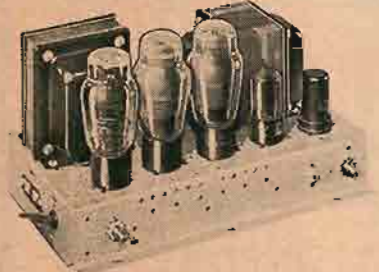

**MODEL 4 LH**—The basic amplifier of medium gain for use with tuners and studio monitors, etc. Expressly designed for tuners incorporating bass and treble controls and pre-amplifier stage for phono. Tube compliment, 1-6J5, 1-6SN7, 2-6L6G, 1-5U4. Size 7" W x 8" H x 11" L. Net price **\$64.00**

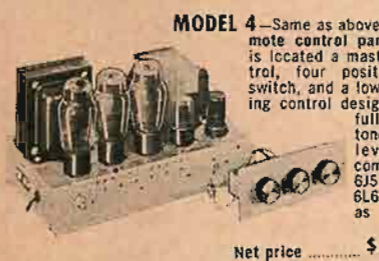

**MODEL 4**—Same as above with with remote control panel on which is located a master level control, four position selector switch, and a low level listening control designed to allow full round, rich tone at whisper levels. Tube compliment 1-6J5, 1-6SN7, 2-6L6G, 1-5U4. Size as above. Net price **\$68.00**

Startling Performance at a price everyone can afford! These famous amplifiers give a new concept to the phrase Hi-Fidelity. They have been rated "Superb" by sound engineers who know!

Leading consumer research organizations have found them very conservatively rated! The frequency response is from 18 to well beyond 20,000 cycles within 1 Db. Presence effect is truly astounding, reproduction is rich, brilliant and crisp. Noise, hum and harmonic distortion have been reduced to the vanishing point, — 85 Db below 20 watts.

Harmonic distortion is only 1/2% at 19.6 watts (40 watts peak), with 40 Db feed back. Hum, and noise measure less than 1 milli-volt across a 10 ohm load.



**MODEL 3**—Same as 4 LH but with an additional 1-6J5 for the bass and treble boost controls which are incorporated. Size same as Model 4 LH. Net price **\$85.00**

### High Fidelity GROMMES AMPLIFIERS



**Model 50PG**. 10 Watt Amplifier with built-in pre-amp. Range: \*20-20,000 cps ± 5 db (= k db 30-20,000 at 10 watts), Distortion: Harmonic 1.5%, Intermodulation 2%, at 10 watts. Hum and noise 80 db below output. 4 inputs. No. A1326 ..... Net **\$48.75**

**Model LJ**. Low Cost Music Amplifier. 8 watts, with 2% harmonic distortion. 40-15,000 cps, ± 1 db. 3 inputs. Preamp. Bass and treble controls. No. A1325 ..... Net **\$32.34**



## FAMOUS Concertone TAPE RECORDER

The Concertone meets all professional requirements, yet is priced exceptionally low! Equalization conforms to NAB Recommended Broadcast Standards. Extended Frequency Response is 50 to 15,000 cps = 2 db at 15" per second speed. Tape Noise down to random level. Also has 7.5" per sec. Speed. Pre-aligned heads quickly interchangeable for

Dual or Single Track Recording. Total Harmonic Distortion less than 2% at normal maximum signal level. Has 3 dynamically balanced motors, separate heads for recording, erase, and playback. Simultaneous monitoring from tape while recording. Instant choice of 7.5" or 15" per second speeds. Fast Forward, Rewind, and Reverse (2500 ft. per min.). All controls are interlocked to prevent spillage or tearing of tape. Size of basic recorder: 22 x 14 x 5" mtg. depth below panel. Use with any good quality amplifier.

AVAILABLE AS BASIC UNIT WITH CARRYING CASE OR CONSOLE CABINET

**BASIC RECORDER, 1401D**: Drive mechanism, power supply, erase, record, and playback preamplifiers, mounted on base plate, ready for installation. With Dual Track Heads. No. A16147, Net **\$345.00**

**Model 1401S**, same with Single Track Heads, Net **\$345.00**



### JENSEN G-610 TRI-AXIAL SPKR.

Finest loudspeaker ever built! 15" 3-way system achieves closest approach to actual "presence." Reaches well above 18,000 cps. 3 individually driven elements with xover and control network. 35 watts, 16 ohms. **\$224.91** #A20144

WE STOCK AND DEMONSTRATE ALL STANDARD MAKES OF HIGH-FIDELITY EQUIPMENT FOR PROFESSIONAL OR HOME INSTALLATION. VISIT OUR SOUND STUDIOS Write for literature on all makes

UPTOWN: 48 West 48th St., New York 19, N. Y.

DOWNTOWN: 212 Fulton St., New York 7, N. Y.

PHONE: Circle 6-4060

# HUDSON RADIO & TELEVISION CORP.

Formerly Newark Electric Co., Inc., of New York

## Sensational HIGH-FIDELITY PACKAGE SPECIAL!

Complete system consisting of the following famous makes:

### Famous COLLINS HI-FI TUNER



High Fidelity At Its Best!

All the technical skill and craftsmanship possible have been incorporated into Collins Audio products. As a result these units closely approach custom-built quality, which is apparent upon inspection and demonstration. **COLLINS FM-11 FM TUNER**. Surpasses the performance of any units in its price class. 9 miniature tubes, plus tuning eye and rectifier. 19 1/4 x 12 x 7 1/4.

### BELL AMPLIFIER Model 2122



Superb performance and excellent quality at a popular price! Ideal for reproducing the extended range of micro-groove records and FM broadcast! Has separate bass and treble tone controls. Frequency range ± 3/4 db from 30 to 15,000 cps when controls are set for flat response. Hum level: — 65 db below rated output of 10 watts with less than 3% distortion. 4 inputs: Radio or Tuner, Crystal Pickup, and 2 Magnetic Pickups, each with built-in pre-amplifier. Output impedances: 3.4 to 4 ohms, 6 to 8 ohms and 15 to 18 ohms—matching most high fidelity speaker systems.

### VM Tri-O-Matic 3-Speed RECORD CHANGER



VM Model 950 GE With magnetic cartridge. Top quality Automatic 3-Speed Record Changer. It plays All Records—All Speeds, All Sizes, All Types, and STOPS AUTOMATICALLY after the last record is played, regardless of size or type! It is extremely simple to operate, having only ONE CONTROL KNOB for all functions: Features Automatic Set-Down Selection for all size records, including 7", and Automatic Manual Control (No Adjustments required). Plays 12-10", 10-12", or 12-7" records automatically—10" and 12" discs may be intermixed if same speed.

### GENERAL ELECTRIC SPEAKER Model S-1201D



GE high fidelity 12" speaker that is recommended by research organizations and music lovers, for superior performance. Frequency response: 50-13,000 cps. Molded cone. Non-warping aluminum foil base voice coil permits power handling capacity of 25 watts. 8 ohms impedance. Superbly

designed and beautifully built to provide true extended range reproduction. With dust cover.

Complete System **Only \$149.95**

Complete Set of Cables \$7.50 extra

# EDITOR'S REPORT

## AUDIANA AGAIN

IF ONE WERE to pick up a few letters at random from those received in this office, one would gather that subscribers wanted (1) more technical articles, (2) more less-technical articles, (3) more record reviews, (4) less record reviews, (5) more articles about broadcast and other professional equipment, (6) no articles about professional equipment, (7) more articles about hearing aids, (8) more articles about home equipment—in short, more articles about everything.

Nobody but nobody, to borrow a phrase from a well known department store's advertisements, can please everybody all the time. Maybe if we were able to make *Æ* into a 500-page issue every month we could. However, we are not complaining—we wouldn't have it any other way. Our only course is to try to give our readers what they ask for—interspersed with what we think they ought to like.

But one thing that has been more and more obvious the last year is the desire for some articles which can be understood by the lay reader—and to that end we are reactivating *AUDIANA*, beginning with this issue as noted below. Henceforth it will be farther back in the magazine, but for its reintroduction it is here, right up front where everyone will see it. Many readers will remember *AUDIANA* from 1950, with a simplified discussion of the problems of sound reproduction in reasonably non-technical language. Experimentally, the new *AUDIANA* will "translate" the more important of the

technical articles into more understandable terms, and sooner or later *all* readers will be on the same plane and nobody will have to read *AUDIANA* any more.

Of course, there was one reader who suggested that those to whom many of *Æ*'s articles were not readily understandable might better follow his example—he studied up elsewhere so he *could* understand us. We can't agree with his viewpoint entirely—many simply do not have the time to learn a new subject from the ground up.

And so, while we are broadening our scope to include more of the interesting aspects of audio, we will still continue to carry the technical articles which have long been the backbone of *Æ*—those which have put *Æ* in the compilations of important articles on audio every year since the first issue. After all, there are many readers who wouldn't be satisfied without something new to build every month. Frankly we can't see how they can keep up with the procession of how-to-build-it articles, but since we have the same inclinations ourselves, we can certainly appreciate their viewpoint.

## SIMPLIFICATION

This simplification is in the direction of getting *Æ* each month. Beginning with the March issue, *Æ* will be on newsstands in eight of the larger cities of the country, and it will be simpler for readers to get it. *Æ* will still be available at your favorite jobber's, and perhaps regular buyers should leave the newsstand copies for new recruits to this interesting field.



### Design of Compensated Volume Controls

The ear does not hear all frequencies with the same sensation of loudness when they are reproduced at the same sound intensity or pressure. Loudness is a term used to identify how loud a sound appears to our ears, in contrast to sound pressure which is an absolute measurement. For example, if we were to attend a concert, we would hear a certain ratio between the sound produced by a clarinet and that produced by a bass viol. Each has its characteristic loudness in the ensemble. But when this same music is reproduced in our living rooms, it is rare that it is played at the same volume; and when we reduce the volume, we change the apparent character of the music. The ratio between the clarinet and the viol has changed, even though the reproducing system may be perfectly flat—that is, with a frequency characteristic which is identical with that of the original sound source.

The actual result of the ear's deficiency is primarily to decrease the apparent bass when music is reproduced at a volume level lower than the original performance—a condition which has been noticed by any listener who has heard music reproduction at a very low level. Considerable scientific effort has been expended to analyze

this effect, with the result that it is possible to predict just how much bass boost must be added to make the reproduction sound like the original, even though it may be much lower in absolute sound pressure.

We are generally accustomed to listening to a radio or phonograph at a sound pressure of 70 to 75 db above the threshold of hearing, at those times when we are actually paying attention to the music, and in the average living room. At a concert, we hear the music at a considerably higher level. In order to make the low-level music sound just like it does in the concert hall, we must therefore boost the low frequencies. This may be done by means of the bass-boost control, but it is more conveniently done by so constructing the volume control that it is done automatically. Thus when the volume control is turned well up, we hear the same volume as in the concert hall, and with the same frequency response—that is, flat. When volume is turned down, the bass is boosted automatically, due to the construction of the control itself. The author has discussed the technical aspects of this control, describing various methods for effecting the compensation as correctly as possible, and in an economical manner.

### Loudspeaker Damping with Dynamic Negative Feedback

When we tow a trailer behind an automobile, we normally use a solid connection between the two vehicles, and the trailer follows closely the speed and direction

changes of the car. To obtain high quality sound reproduction, the cone of a loudspeaker should follow the vibrations of the microphone diaphragm which picks up the original sound. In other words, there should be a tight coupling between the two.

However, such is not actually the case, and the speaker cone does not follow perfectly because of some flexibility in the "coupling," but acts somewhat like the trailer would if it were drawn by a long spring instead of by a solid drawbar—it would lag when the car started quickly, and it would crowd up against the car when the latter slowed down. The use of negative feedback in the amplifier tends to stiffen this spring, but still does not make it a solid connection. It is as though the solid drawbar were attached to one end of a lever mounted on the trailer while the other end was connected to the solid part of the trailer by a spring. This spring represents the resistance of the voice coil of the speaker, which can not be dispensed with. Now if we can connect another spring at this same point on the lever and extend it back to a point on the drawbar, the flexibility of the coupling will be greatly reduced.

The circuit connection described by Mr. Childs does just about that, and a large part of the flexibility of coupling between the amplifier and the speaker cone is absorbed by the addition of what the author terms "dynamic" negative feedback—the term dynamic denoting the ability to change in proportion to the amount the cone deviates from following the amplifier signal.

## WHAT SPEECH INPUT FACILITIES WILL YOU NEED



# 10 years from now?

Vision into the future is a major requirement in good audio engineering to determine what speech input facilities will be as useful five or ten years from today as now. Certain is the fact that whether video or radio, broadcasting of the future will require more and more studio facilities.

We designed the SA-40 console with the future uppermost in our thinking.

Ultramodern today is the GATES SA-40 speech input console, generously equipped to fulfill the needs of video and radio stations for many years to come. It is known as the console with the extras — extra circuit and switching facilities, extra quality in construction and extra serviceability for maintenance.

If you are planning a studio installation today — think of tomorrow and then think of GATES. Write for your copy of the Gates SPEECH INPUT CATALOG and then study the functional block diagram therein and see for yourself why, if you are planning for the future as well as today, your needs can be best fulfilled by investing in the GATES SA-40 console of tomorrow.

## GATES SA-40 CONSOLE



The SA-40 console is constructed in rugged tilt-back cabinet or available in matching desk (desk not illustrated). All amplifiers are individual units, quickly removable without disrupting remaining circuits; mixer keys of standard PBX type for long life; panel of lifetime anodized aluminum; key knobs in varied colors for circuit identification; beautifully streamlined. Size: 48 inches wide, 21 inches deep, 14½ inches high.

### FACILITIES

Nine mixing channels; five preamplifiers; complete cue, talkback and override facilities; cue type turntable attenuators; and terminals for external patch panel, only a few of the many SA-40 features. Space for two additional preamplifiers provided.



The tilt-back-to-service feature of the SA-40 console provides complete accessibility of all components and terminal connections.



Front view of rack mounted power supply for SA-40 console. Heavy cast aluminum housing 19" wide, 8¾" high, 11" deep, is designed to provide front panel servicing.

### EXCLUSIVE TERMINAL FEATURE ASSURES FLEXIBILITY

Unusual flexibility of operation is provided by bringing many of the circuits such as preamplifier outputs, mixing channel inputs and program and monitoring amplifier inputs to terminal strips. These are, in turn, bridged to other terminals and back into the normal circuit. This permits breaking any major circuit in the console for a patch panel extension.

### PERFORMANCE DATA

<b>DISTORTION</b>	→ Less than 1% from 50 to 15,000 cycles overall from microphone to program line. 2% from microphone to monitoring amplifier output.
<b>NOISE</b>	→ From preamplifier input measured at minus 60 Dbm. to program line measured at plus 8 Dbm. 65 Db. below output level. All other circuit combinations equal or superior.
<b>RESPONSE</b>	→ Within 1.5 Db., 30 - 15,000 cycles.

# GATES

GATES RADIO COMPANY, QUINCY, ILLINOIS, U.S.A.  
MANUFACTURING ENGINEERS SINCE 1922

2700 Polk Avenue, Houston, Texas • Warner Building, Washington, D. C. • International Division, 13 E. 40th St., New York City  
Canadian Marconi Company, Montreal, Quebec

## What's inside a *Radio-Relay* station?

Because microwaves travel in straight lines and the earth is round, there are 123 stations on the transcontinental television route between Boston and Los Angeles. This view of a typical unattended station shows the arrangement of the apparatus which amplifies the signal and sends it on.

**ON THE ROOF** are the lens antennas, each with its horn tapering into a waveguide which leads down to equipment

**ON THE TOP FLOOR**, where the signal is amplified, changed to a different carrier-channel and sent back to another antenna on the roof. Here are testing and switching facilities. Normally unattended, the station is visited periodically for maintenance.

**ON THE THIRD FLOOR** are the plate voltage power supplies for several score electron tubes.

**ON THE SECOND FLOOR** are filament power supplies. Storage batteries on both floors will operate the station in an emergency for several hours, but

**ON THE GROUND FLOOR** is an engine-driven generator which starts on anything more than a brief power failure.

Anything that happens—even an opened door—is reported to the nearest attended station instantly.

Coast-to-coast *Radio-Relay* shows again how scientists at Bell Telephone Laboratories help your telephone service to grow steadily in value to you and to the nation.



# BELL TELEPHONE LABORATORIES

Improving telephone service for America provides careers for creative men in scientific and technical fields.

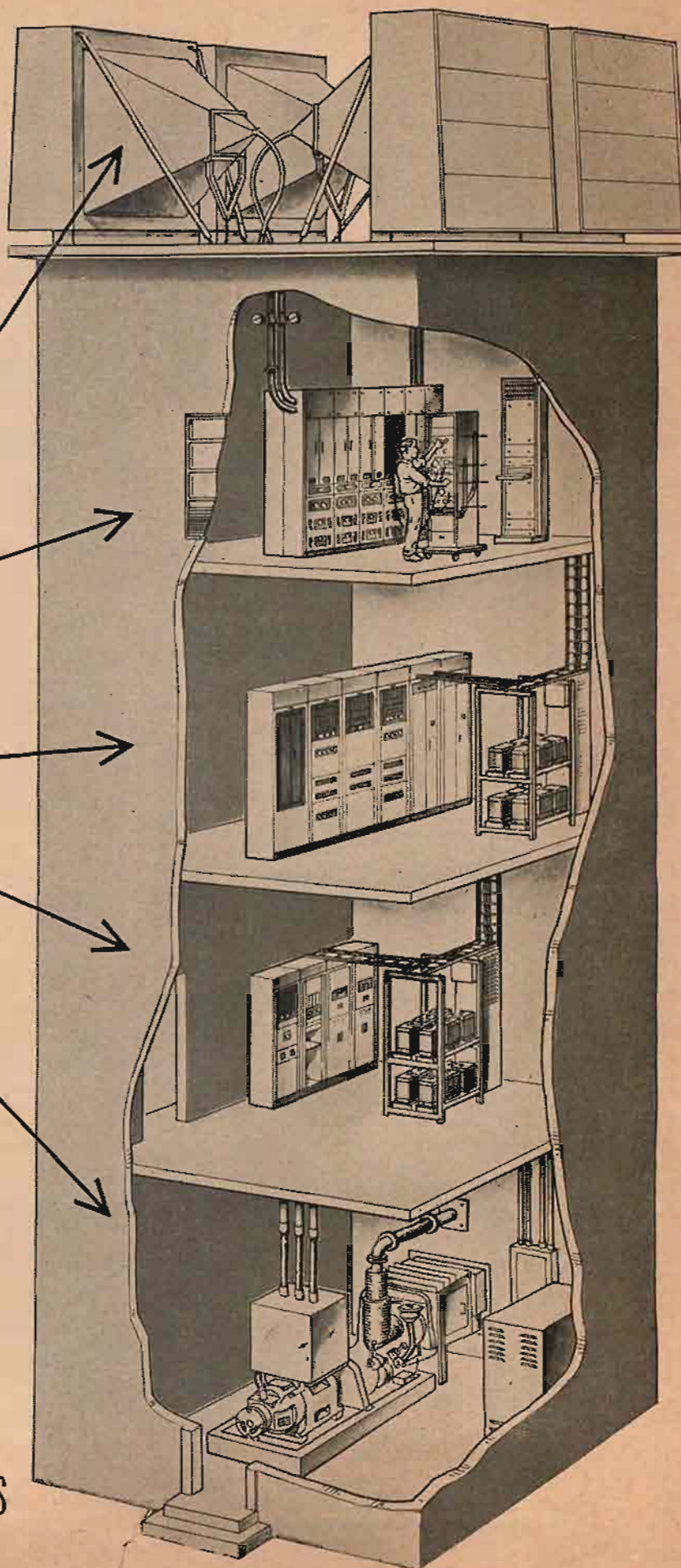

# Loudspeaker Damping with Dynamic Negative Feedback

ULRIC J. CHILDS\*

A further study of the effect of introducing some current feedback in an amplifier to counteract the varying impedance of the loudspeaker. The author gives a practical circuit which is adaptable to any feedback amplifier.

**A**UDIO ENGINEERING has gone a long way since the day when any amplifier with an extended frequency range was considered to be "high fidelity." However, a number of misconceptions still remain. One of them is the question of loudspeaker damping—reduction of overshoot and lag of the speaker cone caused by its inertia, especially at low frequencies when cone excursion is large and the period between impulses is long enough to allow noticeable wave trains to exist. Because only the initial pulse of the wave train is caused by amplifier output signal, the remainder of the movements create signals that are entirely spurious and are detectable as muddiness in the music.

Negative feedback has been widely used in the last few years to lower the internal impedance of the amplifier so that the signal generated by the loudspeaker as a motor during its overshoot is short-circuited by the amplifier, and the same dynamic braking effect is obtained as though a motor armature were shorted with the field excited. However, as Warner Clements pointed out in the August, 1951, issue of *Æ*, there is still a considerable resistance in series with the "short circuit"—the comparatively large internal ohmic resistance of the voice-coil winding itself. Thus ideal dynamic braking is quite impossible with negative feedback of the usual type, since, even with a zero amplifier internal impedance, the average 16-ohm speaker voice coil still places about 10 ohms in the series circuit.

There are two possible methods of achieving perfect or nearly perfect damping in a loudspeaker. The first, obviously only a theoretical possibility, is to use a speaker whose voice-coil wire has no resistance. The second, suggested by Clements and explored in greater detail by the writer, is to add a new type of speaker-control network. The amplifier may be made so sensitive to the movements of the speaker that when the speaker tends to overshoot, the amplifier output is automatically reduced to cancel the overshoot; when the cone lags the signal the output is increased to make the speaker follow the excitation signal. This is done by controlling the inverse feedback present in the system so that it is largely dependent on the behavior

of the speaker and varies from instant to instant.

Although Clements chose to call this kind of feedback positive it is speaker-controlled *negative* feedback, and because its value is dynamic rather than fixed, *dynamic negative feedback* seems to the writer to be an appropriate term.

## Equivalent Circuit

Figure 1 is the equivalent circuit of an amplifier with or without ordinary negative voltage feedback. If the nega-

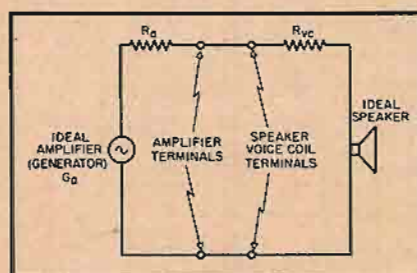

Fig. 1. Equivalent circuit of output-transformer secondary and loudspeaker in idealized system.

tive feedback is high, the value of the amplifier internal impedance  $R_a$  which appears in series with the amplifier as an ideal generator  $G_a$ , is low, and the output voltage at the amplifier terminals does not vary greatly between load and no-load conditions.

The ultimate in this type of design would be reached when  $R_a = 0$ , but this is impossible by ordinary means. However, even with a zero internal amplifier resistance, the internal resistance  $R_{vc}$  of the voice coil remains and is a severely limiting factor in the "short-circuit" current available for damping.

The ideal solution as a basic idea is quite simple: the voltage generated by the speaker due to overshoot, for example, must be applied independently to the amplifier in such a way that it will appear at the amplifier output terminals in the correct phase and at the correct amplitude to restrain the cone from overshooting. Stated in another way, the output of the generator  $G_a$  itself must be controlled by the speaker within wide limits of phase and amplitude so that the circuit will cancel  $R_a$  and  $R_{vc}$ . The speaker then looks back into an impedance of zero ohms and is perfectly damped.

Examination of this scheme indicates that under no condition can speaker

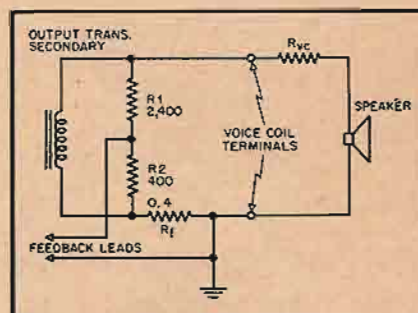

Fig. 2. Circuit which can be adapted to any feedback amplifier to provide improved damping.

damping be perfect. Using a philosophy applicable to any closed-loop control system, no error correction can be had until an error exists, since the error is necessary to create the correction signal. A more cogent limitation is oscillation, which must exist if damping is perfect. However, the method can be used within limitations to obtain improvement in speaker performance which is obvious to the discriminating listener.

## Practical Circuit

Figure 2 shows a basic circuit used to obtain dynamic negative feedback. It is similar to the Clements circuit, but the *net* feedback is not positive.  $R_1$  and  $R_2$  are a voltage divider across the secondary of the amplifier output transformer. The feedback lead is connected to the junction of  $R_1$  and  $R_2$ , with ground at right of the current feedback resistor  $R_f$ . The voltage across  $R_2$  due to the output signal is, of course, in the same phase as that from the output transformer, while the voltage drop across  $R_f$  due to signal current is in opposing phase with respect to the junction of  $R_1$  and  $R_2$ . The net voltage appearing across the feedback leads is therefore that of  $R_2$  minus the  $R_f$  drop. Because the voltage across  $R_2$  is much greater, the net feedback voltage is in the same phase as the amplifier output voltage. It is fed to an early stage at the correct point to make it *negative* feedback.

When the speaker overshoots it generates a voltage 180 deg. out of phase with the signal voltage. This counter-e.m.f. causes a reverse current to pass through  $R_f$ , reducing the existing signal drop across  $R_f$ . The result is an increase in voltage across the feedback leads, an

\*1601 First Avenue, New York 28, N. Y.

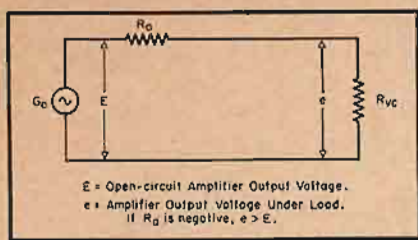

Fig. 3. Equivalent circuit to show effect of complete cancellation of voice-coil resistance by means of feedback.

increase in negative feedback to the amplifier, and a drop in amplifier output voltage.

The negative feedback is dynamically controlled at each instant by the current through  $R_f$  in such a manner as to cause the amplifier output to counteract the spurious actions of the speaker cone; the degree can easily be controlled by varying the value of  $R_f$ —the larger the value the greater the corrective effect.

Even with quite small values of  $R_f$ , the effective amplifier internal resistance may be zero or even negative. An overshooting (high-resistance) speaker causes increase in negative feedback and decreased output voltage; a lagging (low-resistance) speaker causes less negative feedback and more output. This contradicts Ohm's Law, according to which the output voltage of a generator with internal resistance falls as the load resistance decreases. This means that the internal amplifier resistance  $R_a$  is negative. It is still amenable to Ohm's Law except, that instead of causing a voltage drop,  $R_a$  causes a voltage rise, the amount of which depends on the value of the negative resistance.

The corrective effect may theoretically be raised as necessary to compensate exactly for all spurious movement in the speaker. In this case the effective internal resistance of the amplifier would be negative and exactly equal in magnitude to the sum of the  $R_{vc}$ ,  $R_f$ , and any transformer secondary resistance. Regarding the speaker as an ideal zero-resistance generator in series with the voice-coil wire resistance, the generator would look back into a genuine zero impedance and, in effect, would be perfectly braked dynamically. Such a condition is, however, impossible of attainment, even in an amplifier with no phase shift at any frequency, because oscillation would result, as shown by the following demonstration.

Figure 3 is an equivalent circuit of the amplifier, consisting of zero-resistance generator  $G_a$  and internal resistance  $R_a$ , connected to a load  $R_{vc}$ . Assuming that  $R_a$  has a negative value, as would be necessary if it were to cancel out as much as possible of  $R_{vc}$ , the amplifier output voltage will rise when the load is connected. The load voltage  $e$  is therefore higher in amplitude than the open-circuit voltage  $E$ , and the output regulation of the amplifier may be expressed in db at  $20 \log e/E$ . Then

$$e = E \frac{R_{vc}}{R_{vc} + R_a}$$

and rearranging to find the ratio

$$\frac{e}{E} = \frac{R_{vc}}{R_{vc} + R_a} \quad (1)$$

Eq. (1) may now be used to find the regulation with any desired amount of  $R_{vc}$  being cancelled out by a negative value of  $R_a$ . The result, if expressed in db, is a negative number since the regulation is opposite in direction to ordinary positive regulation, i.e., the voltage rises instead of falling when a load is applied.

If one-half the value of  $R_{vc}$  is to be cancelled, then

$$R_a = 0.5R_{vc}$$

$$\frac{e}{E} = \frac{R_{vc}}{R_{vc} - 0.5R_{vc}} = 2 = (-)6 \text{ db.}$$

For example, if the speaker voice coil

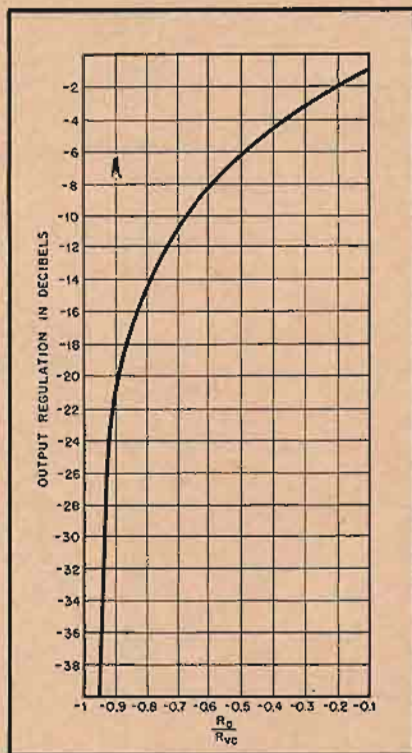

Fig. 4. Curve showing output regulation for varying ratios of amplifier output impedance to speaker voice-coil impedance.

resistance is 10 ohms and the internal resistance of the amplifier is made -5 ohms to cancel half of  $R_{vc}$ , the amplifier output voltage will rise 6 db between no load and full load.

To obtain complete cancellation of  $R_{vc}$ ,  $R_a = -R_{vc}$ . Then

$$\frac{e}{E} = \frac{R_{vc}}{R_{vc} - R_{vc}} = \frac{1}{0} = \infty \quad (2)$$

which means that adding any load whatever, no matter of how high a resistance, causes a rise in output voltage to infinity, which is oscillation. Therefore, it is obvious that perfect damping simply cannot be achieved.

But additional figures on this same subject are of interest. How far is it practical to go? How well can a speaker be damped with dynamic negative feedback? The graph of Fig. 4 was prepared by

using Eq. (1) and converting the resulting voltage ratio to db. It shows what the output regulation of the amplifier must be in order to cancel given portions of  $R_{vc}$ . Note that to cancel as much as 0.8  $R_{vc}$  the regulation must be -14 db. The decibel regulation figure indicates how much of the negative feedback in the loop will be cancelled when the dynamic negative feedback circuit is used. Thus, to cancel 8/10 of  $R_{vc}$ , this loop must have sufficient negative feedback from the junction of  $R_1R_2$  of (Fig. 2) to keep net feedback negative even when a large portion of the negative feedback is removed for use in correcting spurious speaker cone movement. The figure for negative decibel regulation becomes inordinately large as the damping is increased, approaching infinity toward perfect damping, as shown in Eq. (2).

It appears, therefore, that only a limited amount of dynamic negative feedback may be used with the very best practical amplifiers, both for the reason just mentioned and because too great a figure causes the designer to run into severe difficulties with oscillation due to phase shift and response non-linearity at extreme frequencies, even those far above and below audibility.

The Childs amplifier, which the writer has designed (and redesigns from time to time) and constructs for use in better-quality custom installations has flat frequency response to around 100,000 cps and down to 10 cps. About 3 db of dynamic negative feedback has been incorporated in recent models with no danger of instability and with noticeable improvement in the already impressive performance. Even so, intermodulation distortion at the 15-watt level rises from 0.1 per cent to 0.2 per cent.

The graph of Fig. 4 and Eq. (1) are additionally useful to the designer for measuring the dynamic negative feedback caused by a particular value of  $R_f$  in Fig. 2. Each time the value is changed, the open-circuit and loaded output voltages of the amplifier may be measured and converted to decibels. Reference to the graph will then indicate what portion of the speaker's internal resistance has been cancelled. Knowledge of the speaker's resistance will, of course, indicate the exact value in ohms of the internal resistance of the amplifier.

#### Perfect Damping Impossible

The above proof that perfect damping is impossible may be somewhat puzzling in view of Clements' statement that it could be obtained, accompanied by apparent verification with an oscilloscope and a square wave measurement. The error made by Clements was in assuming that an oscilloscope placed across the actual voice-coil terminals could indicate motion of the speaker. The following simple demonstration shows that it cannot do so and that there is, in fact, no practicable way of depicting on an oscilloscope what the speaker cone is doing without the use of fairly elaborate acoustic measurements under ideal con-

ditions or possibly a special type of bridge circuit.

In Fig. 5, (A) and (B) show the amplifier output circuit and the speaker, each equated to an equivalent circuit. The amplifier becomes a zero-resistance generator  $G_a$  with internal resistance  $R_a$  in series, and the speaker consists of another ideal generator  $G_s$  with internal voice-coil resistance  $R_{vc}$ . (C) shows the amplifier connected to the speaker with a 10-ohm potentiometer  $R$  in series with the two and an oscilloscope connected between the zero-voltage reference point (ground) and the arm of  $R$ . The purpose of the demonstration is to show that for any value of negative amplifier resistance we can cause the oscilloscope to show no voltage generated by the speaker, giving us a false impression that the speaker is generating no spurious-movement voltage. The only requirement is that we must be able to place the above-ground lead of the oscilloscope at any desired point on the internal resistance of the speaker. Since it is impossible to do this, we have added  $R$ , which is merely additional voice-coil resistance placed out in the open so we can get at it.

The circuit is again a simple voltage divider as shown in more conventional form at (D). We are not interested in amplifier signal but only in speaker-generated voltage, so  $G_a$  may be considered as simply a short circuited element for the moment.

The voltage in the circuit appears in two phase relationships 180 deg. apart—Phase A being the positive speaker-generated voltage, and Phase B being the negative voltage appearing across the negative resistance of the amplifier  $R_a$ . If the speaker is ringing due to insufficient damping on a square wave it may be seen on the 'scope if it is connected across either a positive or negative voltage. In the former case the actual voltage generated by the speaker will be seen; in the latter the counter-voltage generated by the dynamic negative feedback will be seen, with the

Fig. 6. Equivalents for further study of 'scope indications.

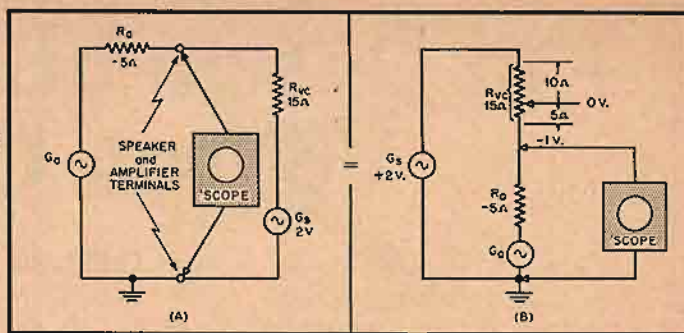

“wiggles” atop the square wave in reversed phase. With the 'scope across zero volts, however, neither is seen, but only the square-wave signal put out by the amplifier. If the amplifier is a good one, the signal will appear to have flat tops.

The total resistance around circuit (D) of Fig. 5 is  $5 + 10 - 5 = 10$  ohms. Since the speaker is generating 2 volts we may say that each 5 ohms drops 1 volt (and each  $-5$  ohms drops 1 volt in the opposite phase).

If the 'scope is connected between ground and point A it will show

$$E_R + E_{R_a} = 2 - 1 = 1 \text{ volt positive.}$$

Thus the 'scope is showing the speaker-generated voltage (Phase A) less a certain amount of correction voltage (Phase B), the resultant giving no useful information.

If the 'scope is connected to point B, it shows  $E_{R_a}$ , which is  $-1$  volt. This is the correction voltage (Phase B) and it will show the “wiggles” in reversed phase. Since the points above and below  $R$  are respectively at  $+1$  and  $-1$  volt, when the arm of  $R$  is at the center, as shown, the 'scope will show no speaker-generated or correction voltage at all and the square wave will appear to be flat. However, the fact that the indication varies with the 'scope connection is proof enough that the appearance of a flat-topped wave is no indication of good speaker performance where there is resistance between  $G_s$  and either 'scope lead.

(A) in Fig. 6 is a similar circuit, this

time showing an ideal speaker  $G_s$  with an internal resistance  $R_{vc}$  of 15 ohms and the 'scope connected across the speaker terminals. This duplicates the scheme used by Clements to adjust feedback. Redrawing the circuit in conventional voltage-divider form at (B) and finding the voltage across the 'scope by the same means as before, the 'scope shows  $-1$  volt (Phase B), i.e., 1 volt of correction signal. It could be made to indicate zero by going into the voice coil and connecting it to the tap on  $R_{vc}$  labelled 0 volt, but this is an obvious impossibility.

It should be clear by now that in order for the 'scope to indicate zero, it must be connected at a point where the speaker-generated and the correction voltages cancel and produce zero. In the case of a perfectly damped speaker this point would be the terminals of the ideal speaker  $G_s$  which are hidden from access. It should also be clear that with the 'scope set at any point it can be made to indicate zero by adjusting the amplifier output impedance  $R_a$  but such an indication will not indicate what the speaker is doing. A third interesting point is that the 'scope cannot indicate zero when connected directly across the amplifier output terminals (across  $G_a$  and  $R_a$  in series) which is in practice also across the speaker terminals ( $G_s$  and  $R_{vc}$  in series) unless the balanced voltages are zero at that point, which means that amplifier output resistance  $R_a$  must be zero—not negative and not positive. Thus when Clements adjusted his amplifier in this way, he adjusted it only for zero resistance at the output terminals. The fact that voltage rose with connection of a load could only have indicated that the value of  $R_a$  was just enough negative to cancel out only the resistances of the output transformer and of  $R_f$ , not that of the voice coil.

#### Adjustment of Circuit

The difficulty of measuring the actual speaker performance is no real handicap, since adjusting the value of  $R_f$  the current feedback resistor does not require such measurement. It is impossible to approach perfect damping anyway and the limiting factor in practice is oscillation due to phase shifts. Even if the limit were the oscillation demonstrated by Figs. 3 and 4 and Eq. (1), the adjustment still would not be made to an optimum point but toward a maximum beyond which it would be impos-

[Continued on page 33]

Fig. 5. Equivalent circuits for study of 'scope patterns as a measure of the effectiveness of output impedance cancellation.

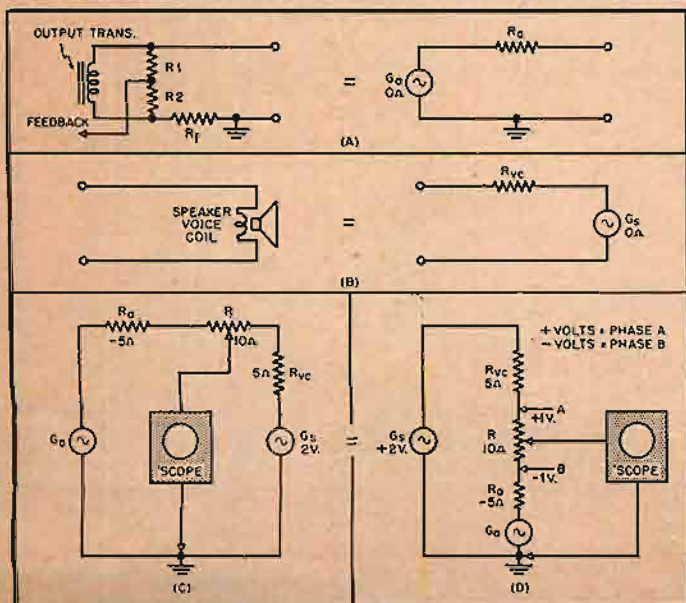

# The Design of Compensated Volume Controls

EMERICK TOTH\*

Part 2. A study of the psychoacoustic considerations involved in designing a control which is practical in construction and adequate in performance.

**A**LL SORTS of separate bass-boost amplifiers and other more complex and expensive schemes are possible, of course, but the happiest solution all around is probably to combine the low-frequency compensator with the usual volume-control potentiometer at the input to the audio amplifier for simultaneous one-knob operation. This makes it possible to avoid any large initial insertion loss caused by the compensator circuit and puts its volume control effect to good use by combining it with the volume control proper. With appropriate proportioning of amplifier gain and input, this combination will also insure a degree of automatic bass compensation which probably represents a reasonable compromise in favor of best theoretical average adjustment, as against individual misuse of an independent control.

Such a combined control has been used in one particular form, as at (B) of Fig. 7, in many receiver designs over a period of about twenty years, affording some, but usually not enough compensation. This form, as well as that of Fig. 6, is based on the fundamental compensator circuit of (A), Fig. 7. As the slider of potentiometer  $R_1$  moves down toward  $R_2$ , the output voltage becomes more nearly the potential drop existing across capacitor  $C_1$ .  $R_2$  is the limiting factor which determines the maximum high-frequency attenuation and, together with

$C_1$ , the upper limit of frequency compensation ( $T = R_2 C_1$ , and  $f_c = \frac{1}{\pi T}$  at +1 db from flat response). This circuit is simple and approaches a maximum of 6 db compensation per octave below  $f_c$ ; unfortunately, as in Fig. 6, it has the fatal defect of not allowing the volume control to reach essentially zero output level, because  $R_2$  must have a rather high finite value (about  $1/20$  of  $R_1$ ). This difficulty can be overcome in inexpensive fashion by shunting  $R_2 C_1$  to ground with part of potentiometer  $R_1$ , which then also provides a d.c. grid-return path. The result is the familiar tapped volume control circuit of (B), Fig. 7. The response obtained with typical values in such a system is shown in Fig. 8. The compensation is not very close to the theoretical values of Fig. 5 for two reasons: (1)  $R_2 C_1$  is shunted by a fixed value of resistance (from the potentiometer tap to ground) which is

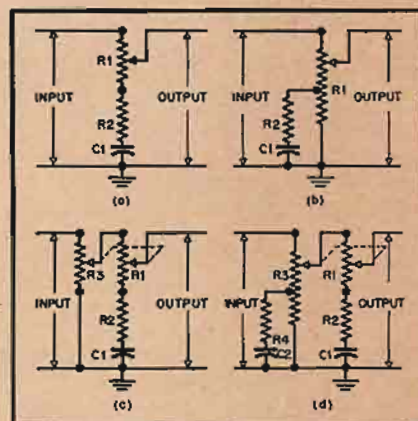

Fig. 7. Bass-compensation input circuits.

generally too low and which consequently seriously limits the rise in voltage across  $C_1$  at the lower frequencies; and (2), the compensation remains fixed at all potentiometer slider positions below the tap.

## Improved Tapped Bass-compensated Volume Control

The performance of this type of control can be improved by a departure from the usual design. Present designs generally have the tap at  $1/2$  or  $1/4$  of the total resistance relative to the grounded end, at a point physically about  $1/3$  of the rotation from ground. It would be better to have the tap at about 20 per cent rotation from ground, with the resistance of tap to ground equal to at least the value from tap to high end. Each section should theoretically have as close to logarithmic taper as feasible, if approximately constant attenuation of sound pressure in decibels per degree of rotation is satisfactory. Linear attenuation in terms of loudness sensation will require a different taper. The tap-to-ground section, however, can be linear without serious disadvantage, since its main function really is to allow the slider to reach ground for "zero" output. Proper choice of values will enable such a control to have about 40 db of attenuation at a substantially constant rate of db per degree in the first counterclockwise 80 per cent sector of rotation. The remaining 20 to 40-plus db, which is usually seldom used, would be concentrated in the last counterclockwise 20 per cent of rotation. Typical values might be:  $R_1 = 1$  megohm, tapped

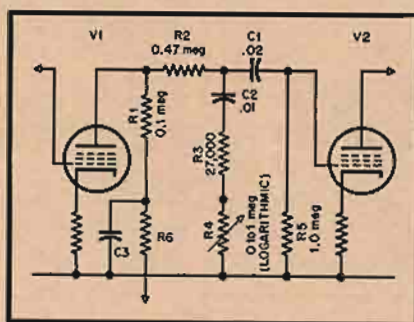

Fig. 6. Interstage bass-compensation circuit.

\* Radio Techniques Branch, Radio Division II, Naval Research Laboratory, Washington, D. C.

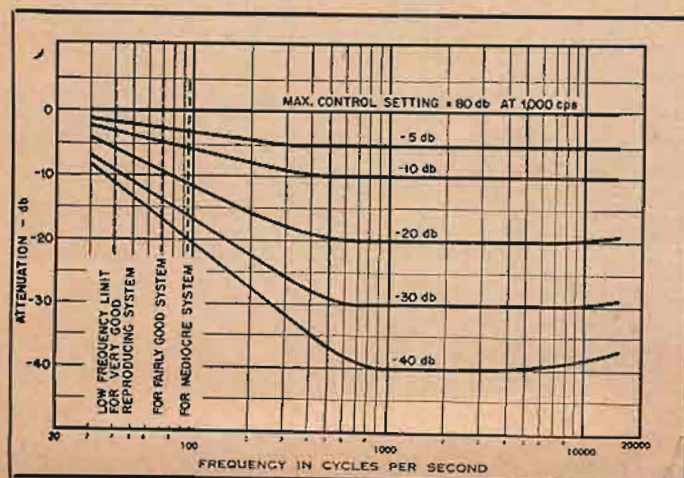

Fig. 5. Theoretical response of volume control compensated to 80-db standard.





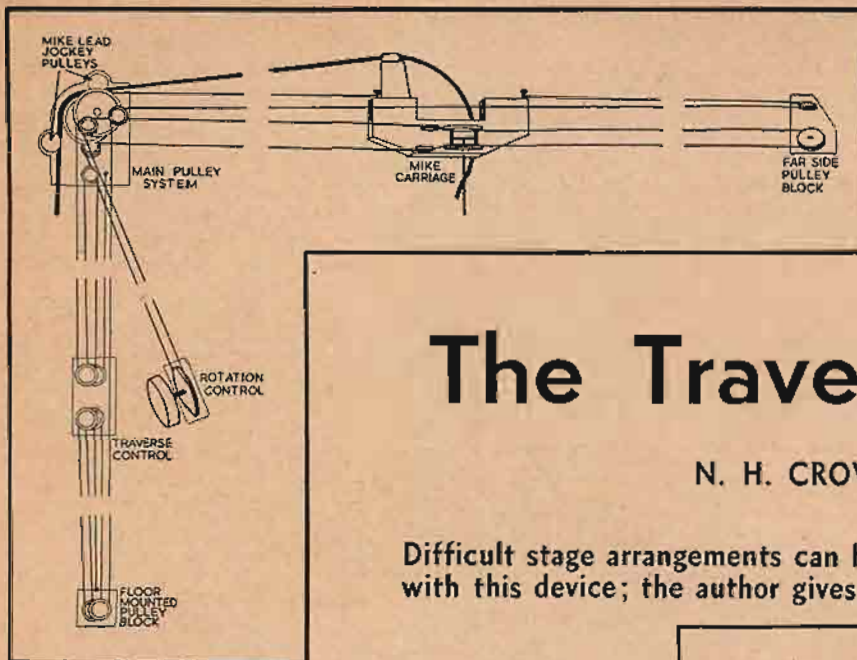

Fig. 3. Diagram of the complete pulley and cord system. (Spindles and other mountings, and also the tensioning arrangements, have been omitted in the interests of clarity.)

# The Traveling Mike

N. H. CROWHURST\*

Difficult stage arrangements can be covered easily from the wings with this device; the author gives adequate constructional details.

SEVERAL WAYS can provide the necessary coverage for sound reinforcing equipment in theatres and halls where sound pick-up is required from a stage of considerable area. Most of them involve the use of several mikes, but there are disadvantages in having several mikes "live" at the same time: One mike, appropriately placed can work with higher gain setting than a group arrangement before acoustic feedback sets in; and the multiple arrangement suffers some loss of quality when the artist occupies an "overlap" in the areas served by two mikes. The traveling mike here described overcomes these disadvantages, and is simple to construct.

The mike used is of the bi-directional

\* 82, Canterbury Grove, London, S.E., 27, England.

Fig. 1. General view of the traveling mike system. The mono-rail is supported at its ends by the vertical "trestles," and intermediately by the steel wires from overhead anchorages.

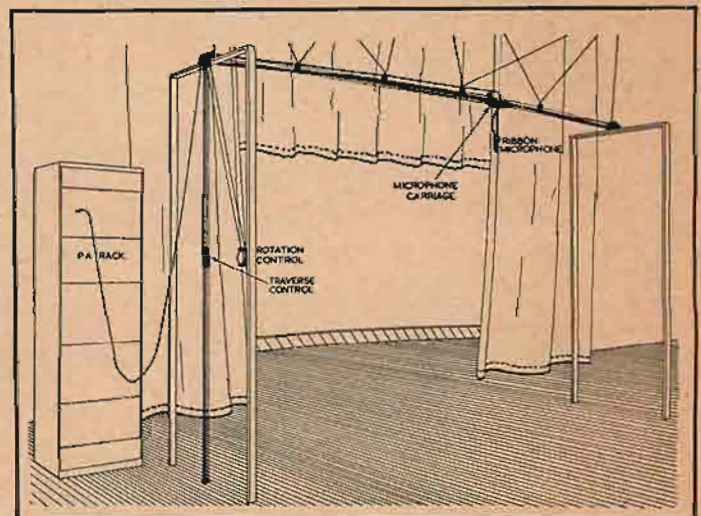

ribbon type. This particularly suits dialogue pick-up, if placed between the artists so they speak to opposite sides of the mike. The traveling arrangement,

combined with the ability of rotating the mike head, enables the mike to be placed at its best position quite readily. It is very useful in picking up dialogue from two people walking across the stage, and for various other scenes where the centre of interest moves about. Instead of the actors' having to modify their acting to suit the mike arrangement (which they seldom do successfully anyway), the mike can be moved about to suit the act. Everyone who has worked in this field will immediately appreciate the advantage.

The mike is fixed in height. The height chosen will depend to some extent on the height of the stage proscenium. The mike must be high enough to clear artists' heads safely, also it should not protrude too far below the overhead curtaining, so as to divert attention when moved. Generally the best height will be related to the size of the building.

Travel across the stage is achieved by mounting the mike on a carriage running on a mono-rail. Two "endless" cords running alongside the rail provide the means of control. One pulls the carriage back and forth along the rail, while the other rotates the mike by means of a

[Continued on page 35]

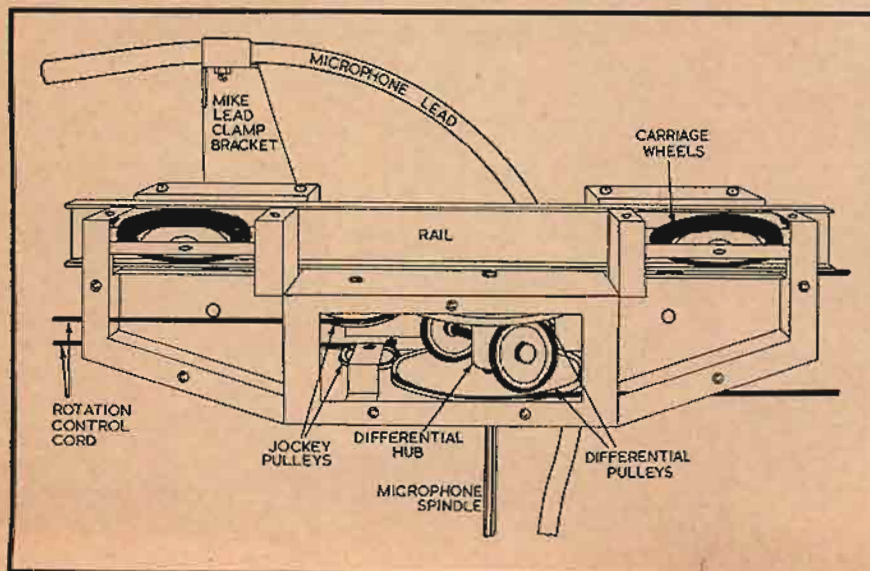

Fig. 2. The microphone carriage with one side-cover removed to show the arrangement of the differential rotation control system.

# Linear-Scale A-F Wattmeter

C. G. McPROUD

Amplifier testing with an intermodulation distortion analyzer is considerably speeded up if power output can be read directly in watts on a linear-scale meter. One solution is presented by the author.

INTERMODULATION-DISTORTION testing has been proven of sufficient value that most amplifier ratings are considered incomplete unless they are included. Since *Æ* begins a series of equipment reports in the next issue, such measurements were deemed necessary, and accordingly a simple IM analyzer was constructed, following the design employed in the instrument described over a year ago.<sup>1</sup> However, as will be apparent to anyone who has had occasion to make a number of such measurements, the amount of IM distortion should be plotted against power output in watts, and the conversion of an output voltage to watts involves considerable figuring, in addition to close interpolation of meter indications to take readings at 1-watt intervals. Accordingly, some means to indicate watts directly, preferably on a linear scale, was desired, and efforts made to develop one.

Power output from an audio amplifier is generally calculated by using the formula

$$P = \frac{E^2}{R}$$

with *E* being measured across the load resistor, *R*, which is selected to match the output of the amplifier under test. While an a.f. voltmeter could be calibrated in watts, the scale would be crowded at the upper end.

After discussing the problem with C. J. LeBel, who suggested that a thermocouple ammeter had a deflection proportional to the square of current, the use of such an instrument was investigated. Consider for example, the use of a 2-amp. thermocouple meter. Power may also be calculated by the formula  $P = I^2R$ , so a 2-amp. meter would give a full-scale indication equivalent to  $4R$  watts. Thus for an 8-ohm load resistor, full-scale deflection would represent 32 watts, and for a 16-ohm load it would represent 64 watts. These ranges are about what would be suitable for measurement of the output power in amplifiers usually considered desirable for home music systems.

<sup>1</sup> John M. van Beuren, "Simplified intermodulation measurements," *AUDIO ENGINEERING*, Nov. 1950, p. 24.

Fig. 1. Intermodulation analyzer built by the author for use in making series of amplifier distortion measurements, and in new equipment development.



Fig. 2. Meter scale for use on 2-amp. C. E. thermocouple meter with calibrations directly in watts output for 8- and 16-ohm loads.

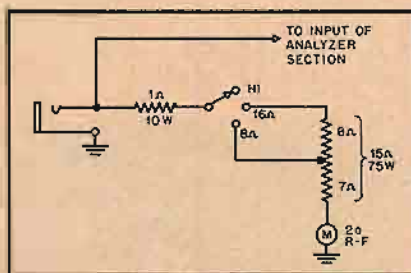
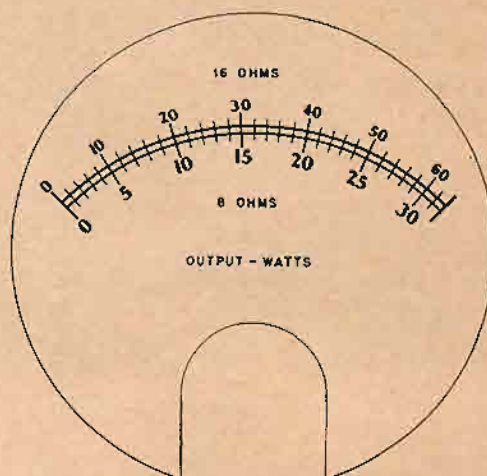

Fig. 3. Input circuit of IM analyzer modified to accommodate load resistor and direct-reading a.f. wattmeter.

### Meter-Scale Configuration

Inspection of various r.f. meters shows a range of scale distributions. For a truly linear current-square scale, the mid-point of the current scale for a 2-amp. meter should be 1.414 amps., and one instrument found to meet this requirement is the 3-inch General Electric instrument. A new scale was hand drawn, with calibrations of 0 to 64 watts above the scale arc, and 0 to 32 watts below the arc. The two scales were labeled 16 ohms and 8 ohms respectively. The completed IM analyzer is shown

in Fig. 1, and the meter scale is reproduced full size in Fig. 2, so it may be cut out and transferred directly to a similar meter in case its use is considered desirable.

The circuit of the input section of the IM analyzer is shown in Fig. 3. With a full-scale range of 64 watts, and to avoid overloading of the load resistor, it seems obvious that the latter should be a 75-watt unit, and this size is available as an adjustable 15-ohm resistor. The resistance of the meter (with its internal shunt) is of the order of 0.2 ohms, so it may be neglected. Since a 20-ohm resistor would not pass 2 amps. within its rating, and since a 16-ohm resistor was not available, a 10-watt, 1-ohm resistor was added, as shown, to make a total of 16 ohms. The switch is marked with three positions—HI is for use when measuring IM distortion in voltage amplifiers where a load resistor was not to be used, and 16 and 8 ohms where it was required. This arrangement provides the greatest facility of measurement, as proven by considerable use of the instrument.

One caution is important. Thermo-

[Continued on page 37]

# Audio in the Home

William C. Shrader\*

Converting a commercial radio-phonograph into a custom installation usually starts with the replacement of the record player and the addition of an FM tuner. The author tells you how.

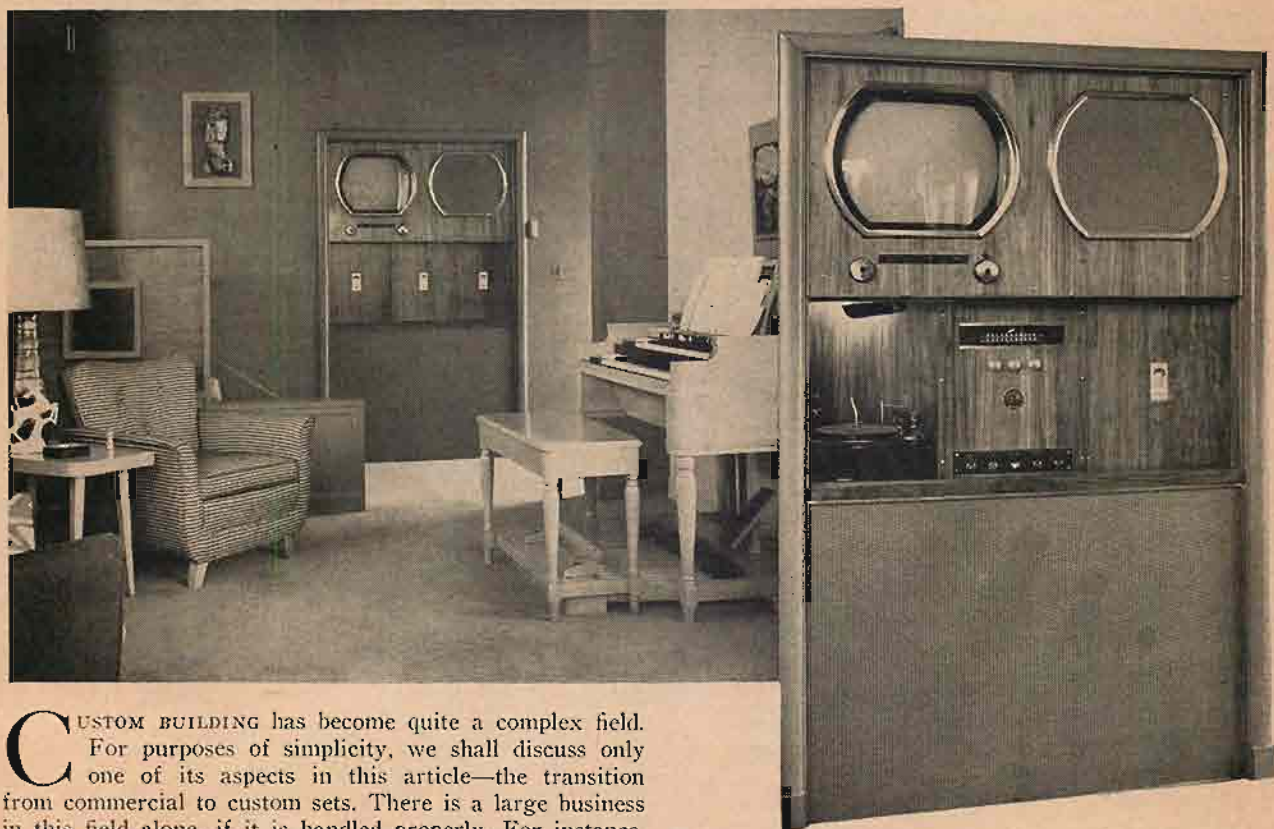

CUSTOM BUILDING has become quite a complex field. For purposes of simplicity, we shall discuss only one of its aspects in this article—the transition from commercial to custom sets. There is a large business in this field alone, if it is handled properly. For instance, it is estimated that it will take about 15 years for a complete transition to LP, even at the present rapid rates. Many people who would like to have a custom installation already have expensive consoles representing a considerable investment which they do not want to “write off” entirely. Commercial consoles, designed for the mass market, put a premium on space, but it is imperative that their owners recognize these pieces of furniture as a great asset. Custom equipment—a tuning device, an amplifier, and a three-speed record player—may be housed in such a cabinet with a modest cash outlay. Since it is the desire for three-speed record players that leads most music lovers to improve their existing sets, and since, in turn, a better record player creates a desire for improvement in the other components, we shall begin with a discussion of their installation.

The Garrard RC80 and the Webster-

Typical home installations made by the author, again showing that the finished appearance is limited only by the imagination of the homeowner.

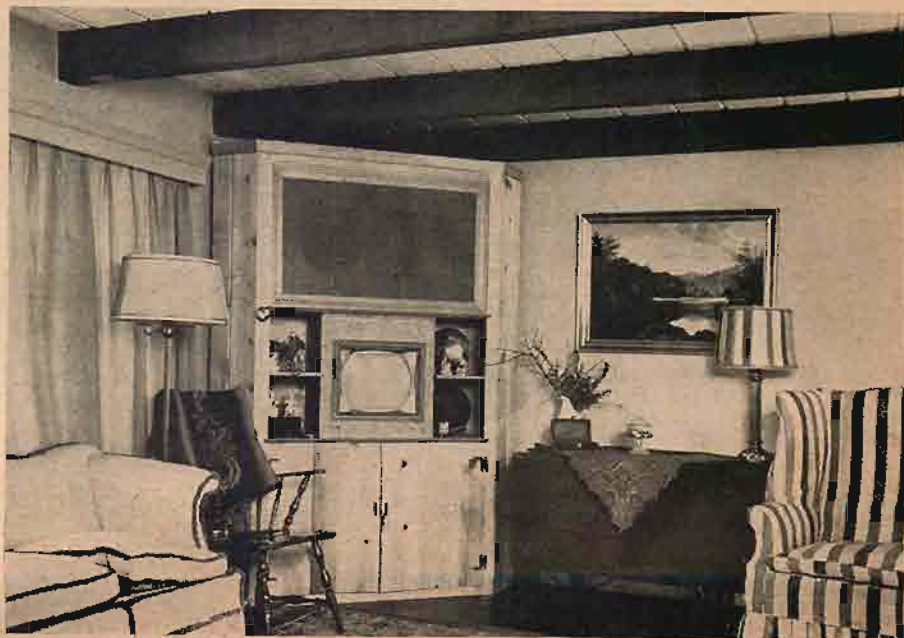

\*President, Shrader Manufacturing Co., Inc., 2803 M Street, N.W., Washington 7, D. C.

Chicago 106-27 are the most satisfactory changers now on the market. Each model is designed for magnetic pickups—which are most desirable—but these require more amplification than is available in an ordinary radio. To overcome this, a pre-amplifier may be added. This sometimes sounds relatively easy. However, we have encountered several difficulties in installations of this type, notably the hum induced into magnetic pick-ups from the stray magnetic fields around power transformers and chokes. Turntable motors used in some changers do not lend themselves to use with extended range cartridges at all because of their excessive rumble.

Fisher and GE make the most satisfactory pre-amplifiers at a low price, and both may be obtained with built-in power supply to simplify installation. By attaching the electric cord to the same outlet as the record changer, no additional power is drawn from the transformers, and hum problems are minimized. In attaching magnetic pickups and pre-amplifiers to an existing radio, all networks of resistors and capacitors must be removed from circuits between the phono input of the radio and the volume control.

Where price is an important consideration, two GE cartridges—one for LP and one for standard, and each properly weighted—make an excellent combination, preferably with a diamond stylus for the LP. Shrillness may be encountered on LP records unless each cartridge is terminated with proper resistance. It is suggested that the GE LP be terminated with a 6800-ohm 1/2-watt resistor, and that the standard be terminated with a 15,000-ohm 1/2-watt resistor. In plug-in heads, such as used with both Garrard and Webster, these can be mounted right across the cartridge.

Pickering cartridges work best with their own pre-amplifier in combination with the 132-E Record Compensator, and with this set-up, no terminating resistors are necessary. When

used with the GE pre-amplifier, a voltage divider should be installed between the compensator and the pre-amp. Such a voltage divider should consist of a 3900-ohm series resistor and a 6800-ohm shunt resistor to ground installed inside the pre-amp for the standard cartridge, as shown in Fig. 1. For the LP, an additional resistance of approximately 3900 to 5000 ohms—depending on personal taste and the other components in the system—may be placed across the pickup head.

With the exception of the Audak, dual cartridges are undesirable, and while the Audak works perfectly well with the Garrard, it is not recommended with the Webster because of hum from the motor. The Audak is the most successful of the dual cartridges because of its weight compensations. Although it could work with two grams on LP, eight grams are required for proper operation on 78's, and this is considered the optimum weight for a dual cartridge. It is a very convenient cartridge, especially for housewives. A table of termination resistor values is furnished with each cartridge, and these values may be used quite successfully with either the GE or Fisher pre-amp. The Pickering pre-amp has insufficient

[Continued on page 27]



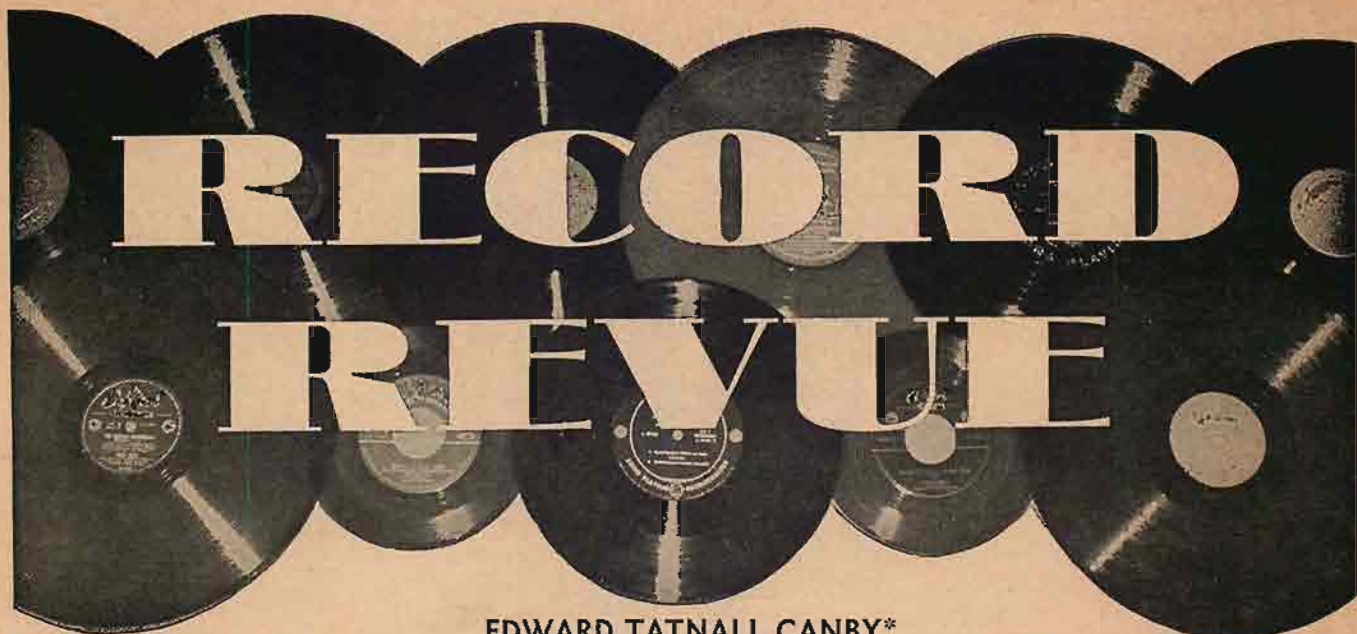

EDWARD TATNALL CANBY\*

## "So-called Audio Engineer"

**T**HE MAIN PURPOSE of this letter," writes a radio listener to me, "is to tell you how happy I felt when you advised your listeners to 'open up your treble and bass' for the Schubert Octet L.P. It so happens that the day before Thanksgiving, my long-anticipated hi-fi set was delivered and I have been in ecstasy ever since."

A happy sort of letter to introduce this month's discussion and I'll quote more of it in a moment, because this "hi-fi" convert expresses himself in a way that should be interesting to all audio makers and electronic experts—here is a fine laboratory specimen (if he will pardon me) of the very best type of audio fan, the person who takes up audio specifically because of what it can do for his music.

It still is a source of astonishment to me how many people are crazy over audio, yet quite apathetic towards the music it makes possible, or even downright antagonistic towards it! For every comment I get on improved musical effects, I run into dozens about improved highs, better transients, middles, lows, and so on, with never so much as a mention of the music in which these improvements (or faults) occur. One might, not knowing the situation, conclude that many an audio fan played nothing on his expensive equipment but audio tone records. Not true, of course. And yet how many people think of the music?

### Walking Audio Analyzer

I'll have to admit immediately that the audio engineer's business is audio, and the more technical the better. I have long since found that my ear is not too trustworthy as to analyzing specific distortions, dips, peaks, etc. because I have too much trouble detaching myself from the music in order to listen specifically to the sound itself. I tend to hear *through* the sound, on into the music, which definitely interferes with my efficiency as a walking audio analyzer. I hear the performer, or more often the composer himself. Like looking through a clean—or dirty—window pane, transmitting a clear—or distorted—scene. It is clearly an expert art to be able to ignore the musical

"scene" and focus the ear on the transmitting process itself which, ideally, should be aurally transparent and therefore inaudible.

### Ultimate Consumer

But let's not get ultimate objectives mixed up with the means towards those objectives. The objective of better audio is, 99 per cent of the time, better music. And the final judgment on better audio is to be found in terms of music itself. And so I continue to quote from the above letter. This is what I mean by judgment in musical terms of an audio improvement.

"Part of the joy (of my new set) is due to your recommendation of the — amplifier. I had my set assembled and cabinetted at one of the jobbers so numerous in New York . . . (and) since Thursday I have enjoyed my records more than ever . . . and my FM programs. My outfit, actually a modest one in the atmosphere of \$500 speakers and ultra-expensive amplifiers, is superb to me. Aside from the very adjustable — amplifier, I have an — FM-AM tuner (*N.B. I'm not giving plugs; the make is not significant in this situation! E.T.C.*), quite satisfactory if a bit thin on the bass end, a defect remedied somewhat by the amplifier bass-boost. The speaker, which I chose out of four or five I heard, is a 15-in. —, giving sublime results.

"Of course I hear passages on my favorite records which I never knew existed, especially triangles, bells, and the like. The Polka from the Age of Gold by Shostakovich, on that early 7-in. Columbia, is my pet demonstration record to shock friends with. And it feels so good to hear the stinging 'cello stab, in the first movement of the London disc of Beethoven's 15th Quartet. The Scherchen Haydn symphonies, and Mass in B Minor are extraordinary . . . they shocked me on my old set, but they throw me to the floor with this one.

"Toscanini's Brahms' First on Victor's 78's is monstrous in sound and my friend brought his old 78 of Toscanini's Beethoven 5th which rocked the walls, 8H and all. Naturally, Bach's 3- and 4-Harpsichord Concerti on Haydn Society are brilliant-er than ever, and Weiss-Mann's Italian Concerto on Allegro sounds like

two symphony orchestras (a marvelous disc indeed, though quite unnatural).

"So as you see, I'm quite excited, and my house, always a haven for my friends, will be even more frequented by those that want to hear their Ansermet Sacre de Printemps and the like. Unfortunately, the neighbors shan't relish my new found joy."

Bet you were fooled by that. The man is no technical expert on music at all and his reactions are definitely not in professional musical terms. He's a listener, like you and me, a person who knows a lot of music by ear and has picked up plenty of his own knowledge concerning listening; his musical repertory is big. But he's an amateur, in both music and audio; and that, may I suggest is our man! Here is the true user of audio, to his and audio's greatest advantage.

### Less Lovely Side

If all letters were as enthusiastic as the above, the audio business could congratulate itself on a job beautifully done. I'm bound, then, to quote a sad representative from a less lovely side of the audio area. This sort of thing goes on entirely too much. It ought to be stopped, for the good of us all. Granted there are plenty of potent problems in putting fancy technical equipment in the hands of those who know nothing about it. Nevertheless, we cannot stand, any of us, for the taking-advantage-of-babes-in-the-woods that is epitomized by this miserable hi-fi addict. I am acutely embarrassed, as will every reader be.

"I am a lover of good music and it means a lot to me to hear such music properly reproduced, over FM and phonograph records, since my wife and I don't go to any live performances.

"Many months ago, being a layman and not knowing better, I bought some expensive high-fidelity equipment from a so-called audio engineer. I realized too late I was spending too much for my pocket. I sold all the equipment save a 16-in. turntable with magnetic cartridges and a diamond styli. The table was held for me by this 'audio engineer' until recently in his store room. It is supposed to be a new machine yet the speed regulator was found to be on the blink. I can't get satisfaction from the above person . . . the manufacturer has not

[Continued on page 22]

\* 279 W. 4th St., New York, 14, N. Y.

# In music, listening quality is everything

*that's what the man says...*

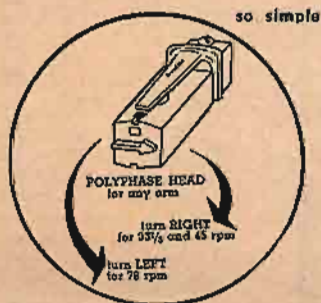

One single magnetic unit plays all home records—Sapphire or Diamond styli.

Special models for radio stations, including Vertical-Lateral units.

“... In music, *listening quality* is everything. My CHROMATIC POLYPHASE has that quality to a degree that I never thought possible. More than that—for the first time, I am now able to test-play a soft master-disk without damaging the groove-walls. I am thrilled with its performance. . . . By the way, after many comparisons, I have decided to use the AUDAX H-5 CUTTER exclusively. . . .” So says the violinist (Toscanini's NBC Symphony) of “Musician's Amplifier” fame.

For years Weil has been preaching that, in reproduced music, listening quality is everything, just as it is at the actual concert. If the quality is present, you can be sure the range is there, too. Although the reverse is seldom the case.

Never before such EAR-QUALITY, such FAITHFUL REPRODUCTION, but . . . after all the reams are written about kilocycles and other laboratory data—when the chips are down—YOU and only YOU can decide what sounds best and most pleasing. Therefore . . . SEE and HEAR POLYPHASE and—You be the judge.



*with the new Compass-pivoted Audax arms and for Record Changers.*

Write for editorial reprint on POLYPHASE Principles

Be sure to obtain a copy of PHONO FACTS from your distributor

## AUDAX COMPANY

500 Fifth Avenue New York 18

“Creator of Fine Electro-Acoustical apparatus for over 25 years.”

only **ALTEC** supplies  
a complete line of  
high fidelity equipment!

Attempts to adapt unmated parts together into a home music system are often unsuccessful. Buy Altec and you not only get the highest quality but you get components designed to work together. Each unit plugs into the others. Easy to install. Designed for eye as well as ear appeal. In home installations as in all other audio fields, the Altec name is your assurance of the best.



**AM-FM TUNER**

**303A** — The best tuner money can buy for audio quality... wide band super het AM... superlative FM... equalized phono preamp... extra input for tape... record cross-over frequency selection... equalization for LP records... bass and treble rise and droop... built in power supply... more dependable features than any other tuner.



**REMOTE AMPLIFIER**

**A-433A** — Beautiful compact control unit for use with phono when 303A tuner is not required. Contains VR phono preamp and all of the novel features found in the 303A tuner... three inputs... perfect for reproduction from records, tape and radio tuners.



**POWER AMPLIFIER**

**A-333A** — The power amplifier without a peer... 15 watts with less than 1/2% harmonic distortion... 27 watts with less than 5% distortion... flat from 20-20,000 cycles... completely controlled from 303A tuner or A-433A remote amplifier.



**LOUDSPEAKER**

**604B DUPLEX** — Still the finest loudspeaker of its type ever produced... proved superior time after time in critical listening tests by experts and laymen... six other models from 8" to 15" also available.

**820A** — Altec's new corner speaker system... the concert grand of the loudspeaker world... two 15" woofers... high frequency speaker and multicellular horn in a furniture cabinet provide famous Altec "Voice of the Theatre" quality for the home.



SEE YOUR DEALER  
OR WRITE TODAY



9356 SANTA MONICA BLVD., BEVERLY HILLS, CALIF.

161 SIXTH AVENUE, NEW YORK 13, NEW YORK

answered a card I sent them on this several months ago.

"At present I have a high fidelity set which I bought from another so-called audio engineer many months ago. To this day the FM is much too bassy and not enough highs while the phono is fine on the highs but there is no bass response from it. I stopped dealing with the 'audio engineer' involved because, over the months, he kept promising to adjust the set and each time he either had some excuse for not coming or just didn't come at all.

"I also found that he was dishonest with me. He claimed that the set had a — amplifier, but the name is nowhere in sight on the amp or preamp, and neither looks exactly the same as the present model on the market. He claimed he sold me a — changer with a synchronous motor. I found out there is no such animal.

"All in all, I have been over-charged for a set that is not working properly. I am loaded down with surplus expensive equipment to sell, and I have been victimized by unreliable and dishonest 'audio engineers.' Can you put me in touch with a reliable 'audio engineer' who won't charge too much to make the necessary adjustments on my set?"

The tragedy of the above (and plenty of similar cases) is that, obviously, there is nothing seriously wrong with his equipment except perhaps the turntable speed control. "Too much bass," "thin highs"—these are, nine times out of ten, simple matters of equalization or matching; a magnetic cartridge is being used unequalized, or a crystal is fed into a preamplifier intended for magnetics, etc. Perhaps there is more trouble here, but I doubt it, having run into this sort of thing a thousand times before.

Perhaps the man is a grouch. (I don't know him.) Perhaps he is all wrong and his "engineers" all right. But the evidence doesn't make it look that way, and I can assure you this letter stands for thousands of other helpless users who, because of utter lack of any audio knowledge, are agonizingly frustrated for months on end when a half hour's tinkering could fix things up to their eternal delight. Not a good situation at all, quite aside from the possible fraud being perpetrated by the "so-called audio engineers" involved. The turntable mentioned here is very expensive and should definitely operate correctly and professionally, to the best of my knowledge. The company's customer liason must be singularly poor. The changer, one of the standard makes, does have a "synchronous" motor like every other fixed-speed model; the implication is that the engineer was suggesting that the motor was something very special—a hysteresis motor, for instance—and he probably asked a special price for it on that score. If so, it was fraud. The whole deal, as they say, smells.

**Better Business**

The weakest aspect of the whole rapidly expanding home audio industry today is this twin business of installation and maintenance. The large distributors have done an excellent job, mostly mail order style, in simplifying installation and the initial choice of components; service is evidently possible through them too, if the ailing equipment can be mailed or shipped. The big-city radio outlets with their new sound-salons and the like also seem to do a good direct-sale job on the choice and installation end at least.

But the "so-called audio engineer," a lone-wolf operator (or even, perhaps, a company), taking advantage of customer enthusiasm and ignorance, is a real menace to



# New 1952 HEATHKITS



**Heathkit TELEVISION GEN. KIT** \$39.50



**Heathkit ELECTRONIC SWITCH KIT** \$19.50



**Heathkit AUDIO GEN. KIT** \$34.50



**Heathkit CONDENSER CHECKER KIT** \$19.50



**Heathkit R. F. SIGNAL GEN. KIT** \$19.50



**Heathkit A.C. VOLTMETER KIT** \$29.50



**Heathkit SQUARE WAVE GEN. KIT** \$29.50



**Heathkit INTERMODULATION ANALYZER KIT** \$39.50



**Heathkit AUDIO FREQ. METER KIT** \$34.50

## Heathkit 5" OSCILLOSCOPE KIT

- New "spot shape" control for spot adjustment — to give really sharp focusing.
- A total of ten tubes including CR tube and five miniatures.
- Cascaded vertical amplifiers followed by phase splitter and balanced push-pull deflection amplifiers.
- Greatly reduced retrace time.
- Step attenuated — frequency compensated — cathode follower vertical input.
- Low impedance vertical gain control for minimum distortion.
- New mounting of phase splitter and deflection amplifier tubes near CR tube base.
- Greatly simplified wiring layout.
- Increased frequency response — useful to 5 MC.
- Tremendous sensitivity .03 RMS per inch Vertical .6V RMS per inch Hor.
- Dual control in vernier sweep frequency circuit — smoother acting.
- Positive or negative peak internal synchronization.
- Multivibrator type Wide Range Sweep Generator.

A brand new 1952 Heathkit Oscilloscope Kit with a multitude of outstanding features and really excellent performance. A scope you'll truly like and certainly want to own.

The kit is complete with all parts including all tubes, power transformer, punched and formed chassis, etc. Detailed instruction manual makes assembly simple and clear — contains step-by-step instructions, pictorials, diagrams, schematic, circuit description and uses of scope. A truly outstanding value.

MODEL 0-7  
SHIPPING WT. 24 LBS.

**\$43.50**



## Heathkit VACUUM TUBE VOLTMETER KIT

- New styling — formd case for beauty.
- New truly compact size — Cabinet 4 1/8" deep x 4-1/16" wide x 7 3/8" high.
- Quality Simpson 200 microamp meter.
- New ohms battery holding clamp and spring clip — assurance of good electrical contact.
- Highest quality precision resistors in multiplier circuit.
- Calibrates on both AC and DC for maximum accuracy.
- Terrific coverage — Reads from 1/2V to 1000V AC, 1/2V to 1000V DC, and 1 to over 1 billion ohms resistance.
- Large, clearly marked meter scales indicate ohms, AC Volts, DC Volts, and DB — has zero set mark for FM alignment.
- New styling presents attractive and professional appearance.

The 1952 Model Heathkit Vacuum Tube Voltmeter! Newly designed cabinet combines style and beauty with compactness. Greatly reduced size to occupy a minimum of space on your work-bench. Covers a tremendous range of measurements and is easy to use. Uses only quality components including 1% precision resistors in multiplier circuit for greatest accuracy, Simpson 200 microamp meter with easy to read scales for fast and sure readings.

All parts come right with kit, and complete instruction manual makes assembly a cinch.

MODEL V-5  
SHIPPING WT. 5 LBS.



**\$24.50**

YOU SAVE BY ORDERING DIRECT FROM MANUFACTURER

EXPORT AGENT  
ROCKE INTERNATIONAL CORP.  
13 E. 40th ST.  
NEW YORK CITY (16)  
CABLE: ARLAB-N.Y.

The **HEATH COMPANY**

... BENTON HARBOR 25, MICHIGAN

Here's why  
those in the know  
—demand

# CANNON PLUGS

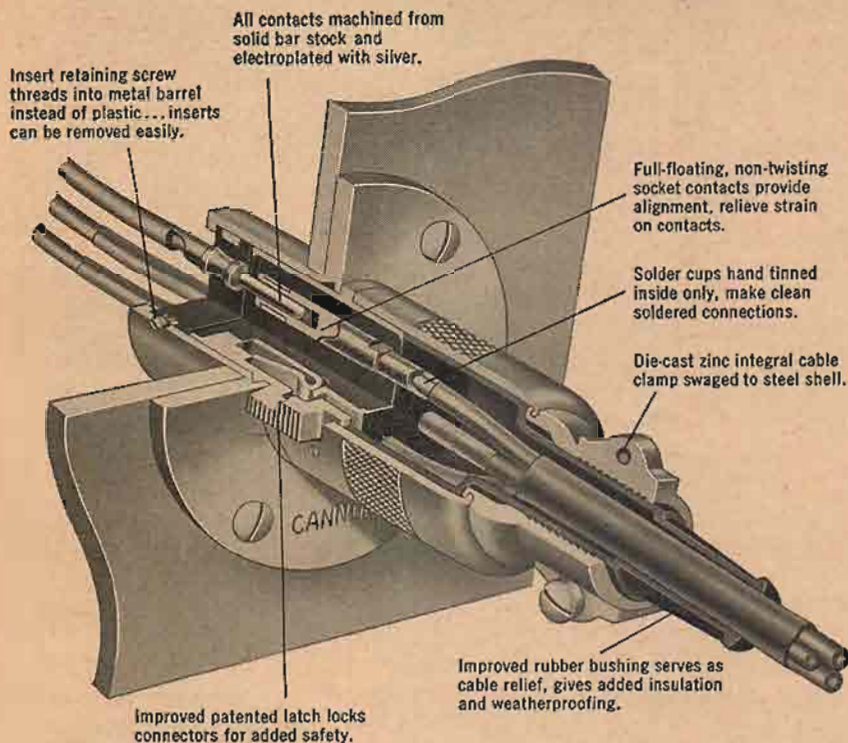

If you talk to sound technicians anywhere you'll find Cannon Type P connectors are the accepted standard of quality... taking a beating day in day out where frequent changes in circuits are required on all kinds of jobs up to 30 amp. capacity.

The close attention to important details called out in the above illustration is typical of the care used in the design and construction of all Cannon Plugs—the world's most complete line.

The above type series is distributed through selected franchise distributors. The line is fully described in the Type P Bulletin. Engineering bulletins describing each of the many basic types of Cannon Plugs will be sent on request.

Type P insert arrangements include 2-3-4-5-6 and 8 contacts. All contacts are 30 amp. capacity except those in P-8 layout which are 15 amp. Full scale layouts, front view pin insert, engaging side, shown at right.



P-3



P-8

## CANNON ELECTRIC

Since 1915

CANNON ELECTRIC COMPANY  
LOS ANGELES 31, CALIFORNIA

Factories in Los Angeles, Toronto, New Haven. Representatives in principal cities. Address inquiries to Cannon Electric Company, Department B-109, P. O. Box 75, Lincoln Heights Station, Los Angeles 31, California.

the whole field. So too, in a way, is the well meaning friend, amateur, or professional, who "loads down" the bewildered music lover with stuff he doesn't know how to use, then dodges the problem of making it work. Incalculable damage is done to audio's reputation by every instance of this sort of operation.

It's not for me to organize some sort of guidance in this area, but I strongly suggest that a "better business" committee or equivalent be set up in the audio industry to begin the huge job of regulating, by constructive suggestion or by force, the unscrupulous or misguided activities of those who sell audio too fast and too loosely. Unethical practices are rampant, I'd say, and opportunities are at hand everywhere, what with "high fidelity" a big appeal and knowledge of it abysmally low. But plain confusion is even more widespread.

Where can a purchaser of good equipment go for regular maintenance and repair service? What sort of guarantee should apply to composite outfits sold as complete packages? What service policy, if any, should an outlet offer on its components? How can we educate the average radio repair man to the point of servicing our better equipment? How can we placate him on the loss of a "jist" sale when equipment is brought in from outside sources—as is almost universally the case these days? Important questions, if the name "audio engineer" is to remain in public good standing.

### Speech on LP

**Romeo and Juliet**—Margaret Webster Production. Eva Le Gallienne, Dennis King, Richard Waring. **Atlantic #401 (2)**

Shakespeare almost complete and an excellent production, in the traditional manner, the top roles good, the recording wide range and plenty clear. Modified Tchaikowsky for bridges and background, plus simple sound effects.

**Romeo and Juliet Excerpts; Soliloquies from Hamlet; Five Sonnets.** John Gielgud; Pamela Brown. **Decca DL 9504**

Gielgud is highly dramatic, with much vibrato, heavy breathing; some will be annoyed, others will enjoy! Excellent speech recording, minus music. Very smooth.

**The Only Jealousy of Emer.** Yeats. Paula Bauersmith, Gerald E. McGonagill, etc. Music by Lou Harrison. Verse choir.

**Esoteric ES 506**

Frankly, this gives me the willies. The lyric, sing-song Irish dramatics, so special and rare an expression when done right by the Irish, is here (to my ear) absurdly exaggerated, in the worst manner of a "speech class" hard at work! Stage English is scarcely understandable. Nice, if rather limited music by Lou Harrison (might be better in a more proper atmosphere). Speakers mostly too far from mike; some blasting, and highs are lacking (tape alignment?).

**Selections from "The Temple" (Herbert). 14 Poems of Emily Dickenson.** Read by Austin Warren. **Idiom LP EO-LQC 12957/8**

Here's an interesting technical exposition on the nature of monaural reproduction! This poetry is read by a "perfessor," clearly a man well used to reading poetry out loud, known and revered for it, effective at it. But monaurally, via the mike, his technique is astonishingly wrong, the poetry ineffective and hard to understand.

The "live" lecturer uses a wholly different speaking technique than the radio speaker. Sudden and large changes of volume for dramatic emphasis, excellent live, are death to the mike, as are shurrings-over of weak syllables, the tendency to mumble the less important parts of sentences. Diction must be far more even, via the mike. Emphasis must be achieved entirely in the pitch level and in the significant pause. These things a

\* 809 Amherst, Ann Arbor, Mich.

platform lecturer does not know (unless he catches on almost instinctively, as some do). On this score, the professors must learn from the radio announcers, like it or not. The old order changeth.

**Abraham Lincoln.** (Poetry and Prose of Lincoln, Markham, Rosemary Benet, Vachel Lindsay, Whitman, read by Walter Huston, Carl Sandburg, Agnes Moorehead, Orson Wells. (Some with Music).

**Decca LP DL 8515**

... And here is the necessary rejoinder. Words by, and concerning, Lincoln, read in this case by a galaxy of big professionals, expert in the craft of miked speech. Old Sandburg is a law unto himself, but that law included an instinctive understanding of the mike. Huston, Moorehead do usual standard effective radio-style job (the professors won't like it much, nor do I).

Orson Welles, though, is a genius at mike technique. If you want to study genius in this special area, try his "Second Inaugural" here. Welles conceives for this reading a tired Lincoln, exhausted by the long war, not far from his own death. To do this, Welles must slur over words, read in tired voice, trail off his sentences—i.e. disobey all the rules. Yet so perfectly does Welles know his mike that his reading here is completely intelligible, to the last word, and tremendously effective. This is the "art" of mike technique—to simulate an effect, act it, rather than to do it literally, as does Austin Warren in the preceding listing.

**Spanish Through Pictures.** I. A. Richards, Ruth Metcalf, Christine Gibson, With Pocket Book. **\*\*Ed. Svces. LP (2)**

Second in an excellent LP series of modern language courses. Reader says sentences, you repeat, while looking at same in print in accompanying Pocket Book (same title); meaning comes through silly but effective little line drawings. Much skillful repetition of key words, phrases, gradually extends your vocabulary. LP allows lots of time at low cost. (How can anyone buy one of the old 78 language courses any more!) Recording below par, but adequate for intelligibility. I've tried this set—and by golly, it works. (See also "French Through Pictures," same system; more to come.)

**The Quick and the Dead.** vol. i, The Atom Bomb; vol. ii, The Hydrogen Bomb. Bob Hope, W. L. Laurence, etc. (NBC Broadcasts) **RCA Victor LM 1129/30**

Another LP issue of broadcast documentary. These were long educational programs on NBC, here transcribed over four LP faces. Hope, the dope, makes foolish comments, asks dumb questions; W. L. Laurence, top journalistic expert on A- and H-stuff, does the narrating. Laurence is folksy, sincere, gives first-hand information, but he goes terribly slowly, the whole production—for radio—is astonishingly slow-paced. Excellent stuff, but for record buyers it could be a lot more adult. And about half as long, maybe. Nevertheless, don't overlook these as unique educational material.

**Robert Frost Reading his own Poems.** Two 10" LP's (Also 78's).

**\*\*\*Nat. Council of Teachers of Eng.**

Replacing an old but good set of shellac 12-in. records, these LP's have improved quality. But Frost, being older—though he still does an excellent job—tends here to read without full conviction; he's been reading these things for so many years, time after time. Frost knows his mike, instinctively, and it shows at once. You won't miss a word here, and the material is thoroughly enjoyable, beautifully natural, homespun, unaffected. Technical work by RCA.

**Illegitimate Sonnets; Clinical Sonnets.** Merrill Moore reading his poetry, with commentary. **\*\*\*Harvard Vocabulary LP**

A genuine experiment in pure LP and significant for all who follow progress in recorded art. The poet here "ad libs" his commentary, at ease.

\*\* Educational Services, 1702 K St., N. W. Washington 6, D. C.  
\*\*\* 211 W. 68th St., Chicago 21.  
\*\*\*\* Bus. Mgr., Harvard Univ. Libr., Cambridge, Mass.



Ask one of our 3M Service Engineers

## FOR A "SOUND SOLUTION" TO ANY TAPE RECORDING PROBLEM

Eighty 3M engineers in the field—backed by twenty technical experts in the 3M laboratories—stand ready to help you with any tape recording problem.

This 3M Service Organization works daily with radio station engineers, electronic engineers and industries using tape recordings in process or quality control. The same electronic and engineering know-how that produced and perfected the famous "SCOTCH" Sound Recording Tape offers you technical assistance on every phase of sound recording.

If you are using sound recording equipment in your radio station, laboratory or business, call upon the 3M Service Representative in your community. He'll be glad to help you make better recordings—more easily. If you are contemplating the use of tape recordings, he'll be glad to analyze your requirements and aid in the selection of equipment.

Call him today—or, if you prefer, write directly to Minnesota Mining & Mfg. Co., Dept. AE-22, St. Paul 6, Minn. No obligation, of course.

Here's why more recording engineers use "SCOTCH" Sound Recording Tape than all other brands combined:

- **REEL TO REEL UNIFORMITY**—controlled coating assures consistent output.
- **THINNER CONSTRUCTION**—resists temperature and humidity changes.
- **NO CURLING OR CUPPING**—tape lies flat on recording head unaffected by humidity.
- **UNIFORM TAPE SURFACE**—no "drop-outs" on recordings due to surface irregularities.
- **LONGER TAPE LIFE**—special lubricating process reduces friction.
- **GREATER SENSITIVITY**—more output on your present machine setting.



The term "SCOTCH" and the plaid design are registered trade-marks for Sound Recording Tape made in U.S.A. by MINNESOTA MINING & MFG. CO., St. Paul 6, Minn.—also makers of "Scotch" Brand Pressure-sensitive Tapes, "Under-seal" Rubberized Coating, "Scotchlite" Reflective Sheeting, "Safety-Walk" Non-slip Surfacing, "3M" Abrasives, "3M" Adhesives. General Export: Minn. Mining & Mfg. Co., International Division, 270 Park Avenue, New York 17, N.Y. In Canada: Minn. Mining & Mfg. of Canada, Ltd., London, Canada.



## AUDIO IN THE HOME

[from page 19]

gain for GE or Audak cartridges, but it works exceptionally well with Pickering cartridges.

Most record changer manufacturers and pickup manufacturers supply sufficient information about templates for motor-board cut-outs, some even furnishing a mounting board to replace existing wood work. If a record changer installation is made properly—keeping the above considerations in mind—the music lover will be gratified by the results. The replacement of other parts of the console are more difficult and require more thought and consideration.

The next improvement which the music lover will seek nowadays is a good FM tuner, largely because of the many good music programs which are broadcast exclusively on FM. Many southern cities affected by electrical storms (to cite an example of dependence on FM for static-free reception) are now able to get noise-free reception

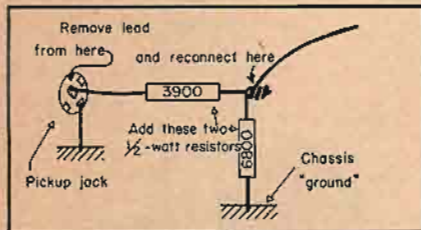

Fig. 1. Method of connecting two resistors at input of GE pre-amp to prevent overload when using with Pickering cartridge.

even from moderately powered FM transmitters, whereas 50-kw AM stations failed to cut through the noise.

Experience with most early post-war commercial sets and many FM tuners then available has left a bitter taste for many people. It is unfortunate that so many sets were sold that had no advantage over AM because of poor design. The biggest problems encountered in FM tuners are excessive drift, insufficient sensitivity, and frequent breakdowns, all of which make the FM receiver no better than mediocre table-model sets. The better FM tuners have none of these faults, however. Another cause of poor FM reception is the failure to install a proper antenna.

We could consider the Meissner 8C or 8CC the *minimum* quality for an FM tuner. With a proper antenna, this set will perform reasonably well, and will remain stable after a 15- to 20-minute warm-up period. The latest models of Browning, Radio Craftsmen, and Brooks seem best suited to custom installations.

It is difficult—if not impossible—to install an FM set in some console models because of a lack of space on the control panel. In some cases, the set may be mounted in the record storage space, but then it is not handy to tune. The problem of mounting an additional tuner will be discussed in this column next month, along with suggestions about replacing the existing amplifier portion of the radio set in the never-ending quest for better sound reproduction.

**"I'm tough and rugged..  
but the SWEETEST mike you ever owned!"**



**TOUGH?**

Yes, the Turner Model 99 Dynamic is the greatest mike in the world for taking hard knocks... yet retains the perfect response and sensitivity that make the 99 an outstanding microphone value.

Indoors or outdoors — for ham rig, broadcast remotes, sound installations — the Turner 99 is completely dependable. For mobile public address systems, paging systems, communications or recording machines, the 99 delivers crisp, clear results. Its smooth response is not affected by heat, cold or humidity.

Specify the Turner Model 99 Dynamic microphone with confidence. Use it with pride. Order from your Turner dealer or representative, or write direct for complete microphone literature.



**TURNER  
Model 99**

Response: 60 — 9000 c.p.s.  
Level: 52 db below 1 volt/dyne/  
sq. cm. at high impedance  
Impedance: 50, 200, 500 ohms  
or high impedance  
List Price -----\$36.00

**THE TURNER COMPANY**

IN CANADA:

Canadian Marconi Co., Ltd.  
Toronto, Ont., & Branches

EXPORT:

Ad. Auriema, 89 Broad Street  
New York 4, N. Y.



929 17th Street N.E.  
Cedar Rapids, Iowa

# NEW PRODUCTS

ANOTHER SIGNATURE FIRST

Now!

## A FULL ACOUSTICAL LENS FOR LOUD SPEAKER USE!



Distributing a uniform sound wave over the entire audio spectrum, the new Jim Lansing acoustical lens smooths out the high frequencies and gives them a mellowness that your ear will appreciate instantly. Unlike the multicellular horn, which performs well at some frequencies but beams or distributes very poorly at others, the new lens is not sensitive to frequency... because the band width is wider than the audio spectrum with which it is used. The new lens and horn is for use with the Jim Lansing #175 high frequency driver.

### TRANSPARENCY CAN BE MEASURED!

Transparency or absorption in the new Jim Lansing acoustical lens is measured in the same way as it is in the optical lens — by index of refraction. The percentage of sound absorbed by the Jim Lansing acoustical lens is less than the percentage of light absorbed by the finest optical lens.



### W-I-D-E DISTRIBUTION ANGLE!

The angle of distribution which is controlled by curvature and index of refraction can now be varied between wide limits... permitting the sound to be concentrated or diffused. The 175 DLH shown above (driver, lens and horn) distributes over a 90° solid angle.

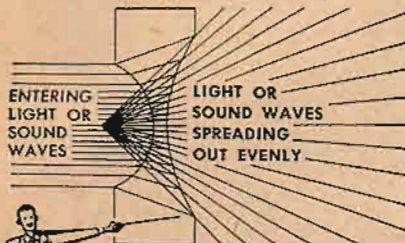

A graphical diagram or ray tracing of the operation of the Jim Lansing acoustical negative lens showing focal point and diffusion angle as controlled by curvature and index of refraction.

Ask your audio dealer for demonstration of the new Jim Lansing acoustical lens today!

**JAMES B. LANSING  
SOUND, INC.**

2439 FLETCHER DRIVE  
LOS ANGELES 39, CALIFORNIA

FIRST IN FINE SOUND

• **Portable Transcription Player.** Many needs of schools and industry will be served by the Model TR-18AM combination record player and public address system. Capable of handling records of any size up to 17½ in. diameter, the player provides operation at 33 1/3, 45, or 78 r.p.m., with a special control to provide



minor variation from the three standards. Weighted 10-in. turntable contributes to stability. Circuitry of the unit includes a built-in scratch suppressor. Standard equipment includes a GE variable reluctance pickup. Power output is 10 watts. Manufactured by Newcomb Audio Products Co., 6824 Lexington Ave., Hollywood, Calif.

• **Wide Range Speaker.** Exceptional dispersion of high frequencies is a feature of the new University Diffusicone-12, a 30-watt speaker designed to fill the need for a high-quality unit in the moderate price field. High-frequency response extends beyond 13,000 cps. The "diffusor" element provides dual horn loading of the speaker apex, thus substantially increasing efficiency in the upper frequency range, at the same time affording radial projection and aperture diffusion to assure



reception of the speaker's entire range of reproduction irrespective of the listener's location. Constructional features include a 1½ lb Alnico V magnet and a 2-in. voice coil. Design of the Diffusicone-12 permits replacement of either the diaphragm-basket assembly, or the magnet, in a matter of minutes with an ordinary screw driver the only required tool. A complete catalog sheet, including cabinet drawings, will be supplied free on request to University Loudspeakers, Inc., 80 S. Kensico Ave., White Plains, N. Y.

• **Pre-Fabricated FM-AM Tuner Kit.** A recent departure in tuner design is the new Collins "Pre-Fab" model. Made up of four wired and tested sub-assemblies, the tuner is easily completed by the user with substantial savings over the cost of a finished unit. The Pre-Fab kit is composed of (1) the FM r.f. tuning circuit, (2) the FM i.f. amplifier, (3) the AM tuning circuit, and (4) the chassis assembly which

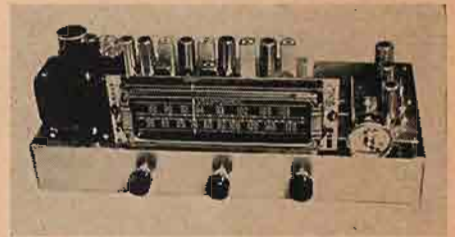

includes power supply and necessary hardware. Each unit is mounted, wired, tested, and aligned at the factory, and the same tubes used during tests are included with the kit when shipped, thus eliminating the need for intricate alignment procedures on the part of the user. Average sensitivity of the completed tuner is 6 to 10 microvolts. Physical dimensions are 6 x 8 x 17 ins. Collins Audio Products Company, P. O. Box 368, Westfield, N. J.

• **Miniature Audio Oscillator.** Although tiny in size, the new Waveforms Model 510-B extended-range audio oscillator equals in performance many of its standard-size counter-parts. A precision instrument in every respect, it measures but 6 x 4¼ x 5¼ ins. Frequency range is 18 cps to 1.2 mc in five overlapping ranges. Constant output is within ±0.5 db from 18 cps to 100 kc. Distortion is less than 0.2 per cent over most of useful range.



Output voltage is calibrated, and the unit is equipped with a 300-deg. vernier-drive dial. Operation with balanced output is afforded by means of Type T-10 matching transformer available as accessory. Manufactured by Waveforms, Inc., 333 Sixth Ave., New York 14, N. Y.

• **Corner Cabinet Kit.** A new kit which, when assembled, makes an acoustically correct folded-horn corner speaker enclosure, is the newest addition to the line of cabinetry manufactured by G & H Wood Products Co., 75 N. 11th St., Brooklyn 11, N. Y. Sold through jobbers under the company's trade name Cabinart, the

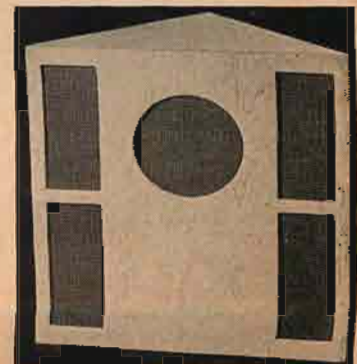

kit is remarkably low priced, and is supplied complete including cut lumber, grill cloth, hardware, plastic wood, acoustic insulation, and assembly instructions.

• **Vacuum-Tube Voltmeter.** Hickok's new Model 215 VTVM affords laboratory accuracy in an instrument designed essentially for field engineers and service technicians. Featured with the 215 is a new dual-purpose a.c.-d.c. probe with built-in switching. D.c. range is to 1200 volts with



10 megohms input resistance. Readable resistance range is 0.2 ohm to 1000 megohms with center scale reading of 10. A.c. ranges are to 1200 volts rms, and 3200 volts peak-to-peak. Input impedance is 30 megohms shunted by 150 mmf. Frequency response is 40 cps to 3.5 mc. Crystal probe is available as accessory to extend useful range to 250 mc. For complete information write to The Hickok Electrical Instrument Co., 10017 Dupont Ave., Cleveland 3, Ohio.

## NEW LITERATURE

• **Tube Department, Radio Corporation of America, Harrison, N. J.** is now distributing a revised edition of the booklet titled Preferred Tube Types for New Equipment Design. Advances in tube design and application are reflected in many revisions in this latest version of an old standby in the engineering field. Copy will be mailed free on request.

• **Freed Transformer Company, 1718-36 Weirfield St., Brooklyn (Ridgewood) 27, N. Y.** is publishing in booklet form a summary of the many types of transformers and test instruments manufactured by the company, also information on the technical literature the company has available. Will be mailed free on request for "Freed Facts."

• **American Standards Association, 70 E. 45th St., New York 17, N. Y.** has approved and is distributing The American Standard Graphical Symbols for Single (One) Line Electrical Engineering Diagrams, Z32.1.1-1951. Offering for the first time a single volume in which are combined single-line diagrams for use in both power and communication work, this Standard coordinates the diagrams contained in the American Standard Graphical Symbols for Electrical Power and Control, Z32.3-1946, and for Telephone, Telegraph and Radio Use, Z32.5-1944. The Standard contains 81 sections covering symbols for almost all electrical circuits in the field of power and communication. Copy of the Standard may be obtained from the Association upon remittance of \$1.40.

• **Antara Chemicals Division of General Dyestuff Corporation, 435 Hudson St., New York 14, N. Y.** has assembled in booklet form the complete story of the Company's unique product, Carbonyl Iron Powders. This booklet represents industrial publishing at its best. Lavishly illustrated and printed in many colors, it covers the manufacture and usage of iron powders in such a manner that even the most technical aspects of the subject are understandable to the engineer whose sphere of specialization may lie in other fields. A necessity irrespective of what your interest may be in electronic engineering.

# The Discriminating Eventually Come to Leonard's!



WAVEFORMS MODEL A-20-5

Music lovers and critics have acclaimed this superb amplifier as one of the finest at any price. Inputs—Radio, Magnetic phono, 2 others. All with individual controls. Controls—Selector, Volume, Bass, Treble Cutoff. Frequency Response—1 db from 20 to 20,000 cps. Power rating—20 watts.

NET ..... \$199.50



GARRARD RC-80

Professional engineers attest to the outstanding performance of this superb, completely automatic record changer. Heavy-duty constant speed motor assures quiet operation—without "wows." Removable spindle permits removing records without damage. Three speeds. Automatic shut-off. Special heavy duty spindle for 45 rpm records.

NET (less pickup) ..... \$39.00

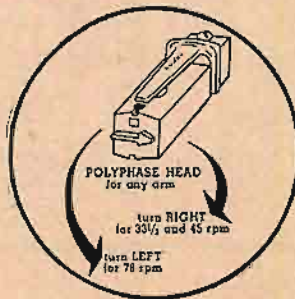

AUDAX CHROMATIC  
DIAMOND POLYPHASE DL6

Thousands of AUDAX owners are acclaiming POLYPHASE reproducers as indispensable where absolute quality of performance is desired. And now the new CHROMATIC POLYPHASE with its near-infinite compliance of record groove and stylus, gives to the listener a new thrill in music reproduction. . . . Never before such Ear-Quality. . . . Never before such absolute fidelity to the original. It is truly "the standard by which others are judged and valued."

NET (with changer adapter) .. \$43.51

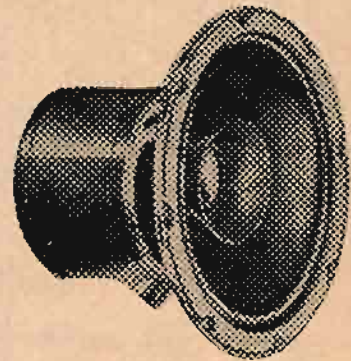

ELECTRO-VOICE  
COAXIAL MODEL SP-12

All the magic of high-fidelity reproduction is yours with the RADAX SUPER-TWELVE loudspeaker system. Coaxial in principle, both low and high frequencies reach respective speakers thru an extremely effective crossover network. Power Rating—25 watts. Frequency Response—70 to 13,000 cps. Impedance—8 ohms.

NET ..... \$52.92

**NEW BIG CATALOGUE:** You'll want our new 48 page Catalogue featuring the latest and finest in equipment for audiophiles. Just drop us a postcard, or phone:

COrtland 7-0315

# Leonard Radio inc.

the house  
built on  
SERVICE

69 CORTLANDT ST., NEW YORK 7, N. Y.

APPROVED • ASTATIC • ATLAS • AUDAK • AUDIO DEVELOPMENT • BELL • BOGEN • BOZAK • BROOKS • BROWNING • BRUSH • CHALLENGER • ELECTRO-VOICE • JENSEN • ESPY

PENTRON • PICKERING • RACON • RADIO CRAFTSMEN • REK-O-KUT • H. H. SCOTT • SHURE • SONAR • UNI-MODE • UNIVERSITY • V-M • WEBSTER - CHICAGO • WEBSTER ELECTRIC

# HARVEY Features the Finest Brands

## WILLIAMSON HR-15 AMPLIFIER KIT



The famous Williamson HR-15 amplifier circuit... now available with the original Partridge transformers built to Williamson's specifications. Build this kit in 3 hours or less, and enjoy sound of a quality you never heard before. The HR-15 is a 2-Chassis power amplifier for use with tuners or other front ends having own volume and tone controls. All American triodes, 2-6SN7GT, 2-807 or 6BG6G in PP output, 5V4G rectifier. Response  $\pm .5$  db, 10-100,000 cycles. Output impedances 1.7 to 109 ohms in 8 steps. Absolute gain 70.8 db. 20 db. of feedback around 4 stages and the output transformers. Kit is Complete with Tubes, Punched Chassis, Pre-wired Resistor Board, Sockets, Genuine Partridge Output Transformer, and All Necessary Parts.....\$76.50

As Above, with CFB Transformer.....\$90.00  
PARTRIDGE Output Transformers available separately WWFB, as used in above kit.....\$26.00  
CFB Transformer, Hermetically sealed.....\$40.00

HR-15T A Williamson Kit with all TRIAD TRANSFORMERS... including power transformer, chokes and specially designed output transformer which is completely sealed in tar.  $\pm 2$  db. 10-100,000 cps. Harmonic Distortion less than .1% - 10 watts output. Output impedances 4-8-16 ohms.....\$69.50  
Both HR-15 and HR-15T Kits available with KT-66 tubes for \$3.00 extra.

IN STOCK...  
THE COMPLETE LINE OF



(Exclusive with HARVEY in the N. Y. area)

Transformers for all applications - Military and Civilian - High Fidelity Audio Components, "Trijets" - Hermetically Sealed Midgets, Power Transformers, Replacements, Filters, Reactors, etc.... for the laboratory, industrial, servicing, public address and radio amateur fields. Complete stocks of all components are on hand for immediate delivery.

The TRIAD "HS" series of transformers incorporates hum-bucking coils and nickel-alloy multiple shielding for minimum pickup. They are small in size, light in weight, rigidly supported and hermetically sealed. Note actual appearance



of the "HS" case, on left, and the telescopic view on the right which illustrates the construction of this particular type.

Write for latest catalog.



NOTE: In view of the rapidly changing market conditions, all prices shown are subject to change without notice and are net, F.O.B., N.Y.C.

Popular-Priced

# GARRARD

## THREE-SPEED RECORD PLAYER



An excellent unit designed to satisfy the increasing demand for a three-speed, single record player. Same sturdy construction and precision parts as the famous GARRARD Record Changer. Four pole, heavy duty silent motor. Hum-free! Rumble-free! Heavy weighted turntable. Interchangeable plug-in heads for crystal or magnetic cartridges.

Model M, less cartridge, only..... \$24.50

Model MC, with dual stylus crystal turnover cartridge, only..... \$29.65

VISIT THE  
AUDIO-TORIUM

Come in and visit our new sound department... all these items and many more on working display at all times.

Telephone (hrc) LUxemburg 2-1500

# HARVEY

RADIO COMPANY, INC.

103 West 43rd St., New York 18, N. Y.

NOTE: In view of the rapidly changing market conditions, all prices shown are subject to change without notice and are Net, F.O.B., N.Y.C.

## VOLUME CONTROLS

[from page 15]

Fig. 7 and adding compensator  $R_4C_2$ . This is equivalent to combining (B) and (C). Proper choice of values and tap can yield a closer approximation to the theoretical curves of Fig. 5.

### Apparent Loudness and Room Noise

The compensated control has the advantage of making listening easier in the presence of room noise, as indicated by Fig. 12. A good deal of the power in music and speech is concentrated in the frequency region below 500 cps. Compensating a 50-db-level program so that it approaches the over-all frequency response of an uncompensated 80 db average level can make the program sound much louder without increase in annoyance factor, because proper balance of bass and treble prevents the shrillness which often characterizes the uncompensated low-level reproduction of voice or music. This makes background music to meals or conversation much more soothing and pleasant.

Both the noise and the signal curves in Fig. 12 have loudness sensation as it appears to the mind as the ordinate. The usual method of presenting room noise over the audio-frequency range in terms of sound pressure or intensity level tends to give a misleading impression of the annoyance effect of the low-frequency noise components. Fortunately, the ear responds so poorly to low frequencies at the usual room-noise intensity levels that noise such as the hum of 60-cps home machinery remains tolerable.

Listening at lower than concert-hall levels also pays another dividend besides

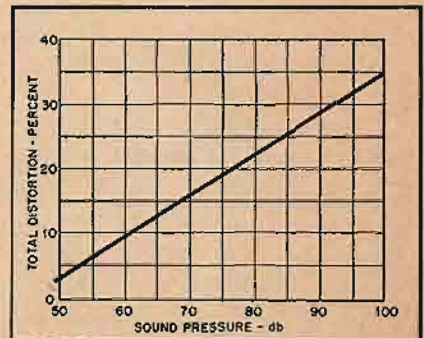

Fig. 13. Harmonic distortion of the human hearing system at 1000 cps. Includes harmonics from second to fifth, inclusive.

toleration by family and neighbors. As Fig. 13 shows, the harmonic distortion of the human hearing system is quite low, less than 3 per cent, at a low sound pressure level such as 50 db.<sup>3</sup> At 80 db, however, the harmonic distortion is high, about 22 per cent, and intermodulation distortion components will be present in

<sup>3</sup> Derived from data on subjective tone measurements; Moe, *J. Acous. Soc. Am.*, 1942.



unpleasantly large quantity on complex tones. Many people react unfavorably to high sound levels; it seems rather likely that this is due not just to distorted reproduction but also to distortion in the individual hearing system. If this is so, no amount of improvement in amplifier and speaker fidelity, or other elements in the reproducer chain will sell loud sound to some persons.

#### Amplifier Power Requirements

It is desirable to have fairly definite knowledge as to the maximum output power requirement of the amplifier needed for the maximum average level of 80-db sound pressure on which the bass compensation previously considered is based. Since the low frequencies will be attenuated much less than the middle and high registers at low-level settings of the volume control, the amplifier will

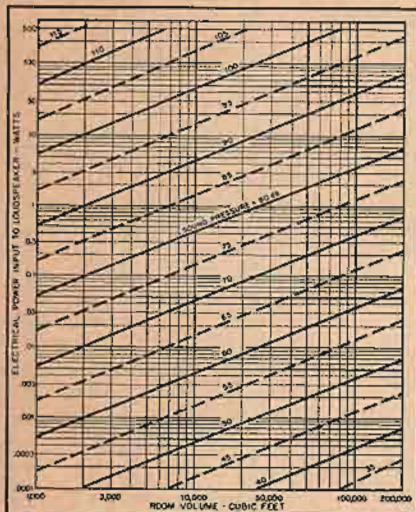

Fig. 14. Loudspeaker power input required for various sound levels, based on 3 per cent efficiency.

be working nearer to full-load conditions than it would without compensation. Figure 14 shows the value required for various room volumes,<sup>4</sup> on the basis of a loudspeaker electrical-to-acoustic power conversion efficiency of 3 per cent, which is fairly representative of the average direct radiator or cone loudspeaker installation. It can be seen that a room of 2000 cubic feet volume (for instance, a living room 17 x 13 x 9 feet) will require 0.1 watt electrical power input to the loudspeaker for 80 db level, and 10 watts for peak levels of 100 db sound pressure. This can be 10 watts of maximum "undistorted" output, which generally means about 5 to 10 per cent electrical distortion. A 5-watt amplifier will, of course, produce 97 db instead of 100 db peak level for the same distortion. As Fig. 13 shows, hearing distortion is about 35 per cent at 100 db sound pressure level, and the amplifier's 5 or 10 per cent will not be too important.

#### Input Level Adjustment

Since the compensation is based on 80

<sup>4</sup> Based on data for acoustic power required at 80-db sound intensity; Olson, *RCA Review*, 1936.

for flawless reproduction  
**NO OTHER CARTRIDGE CAN PERFORM LIKE A PICKERING**  
*Pickering* patented design  
 provides **DYNAMIC COUPLING\***  
 throughout the entire audible range

#### \* DYNAMIC COUPLING ASSURES

- constant stylus contact with the record grooves over the entire audio spectrum (20-20,000 cps)
  - full frequency response
  - full transient response
- NO RESONANCES  
 NO MISTRACKING  
 NO GRINDING OF GROOVE WALLS**

Pickering Cartridges transmit all of the sounds in the musical spectrum, without loss of definition, just as a fine optical lens passes all of the colors in the rainbow.

For literature address Dept. A

Well-informed engineers and technicians, schooled in the science of electro-mechanics, know that only wide-range frequency response provides full transient response; the electronic phenomena which enables the reproduction of orchestral music with all the subtle sounds that give each musical instrument its individual character.

Pickering engineers and designers have but one objective . . . to produce products that will please the music lovers' insatiable appetite for the flawless recreation of recorded music . . . for the utmost in quality insist upon Pickering Audio Components.

**Pickering**  
 & COMPANY, INCORPORATED  
 OCEANSIDE, NEW YORK

## This Audio Oscillator Was Designed With A Thermometer In Mind

El-Tronics "Temperature Design" minimizes thermal drift, while an electronically regulated power supply assures stable operation. No electrolytic capacitors are used. Clean lines make this superb instrument "fit in" for any laboratory—by mounting in a relay rack or table cabinet.

Write for Free Catalog

**SPECIFICATIONS**

- **FREQUENCY COVERAGE:** 20 to 200,000 cycles in four ranges.
- **FREQUENCY RESPONSE:** -1 Db from 20 to 200,000 cycles.
- **FREQUENCY DIAL:** 6" diameter, direct reading, vernier drive.
- **DRIFT:** -2% or better.
- **OUTPUT VOLTAGE:** 0 to 10 volts continuously variable. Standard load: 1000 ohm resistive.
- **DISTORTION:** Less than 1% throughout entire audio range.
- **CALIBRATION ACCURACY:** 1% Rack panel construction. No zero set necessary.
- **POWER SUPPLY:** Nominal 115 volts 50/60 cycles, 60 watts. Electronically regulated internal supply permits operation on line voltage between 105-125v.
- **HUM LEVEL:** Minus 50 Db or better.

2667 N. HOWARD STREET  
 Philadelphia 33, Pa.



## Something worth thinking about—

ARE DAILY  
ADJUSTMENTS  
MAINTAINING  
YOUR  
OPERATING COSTS?

There's a big factor showing up in the tape recording world . . . it's the tragedy of High Maintenance Costs. Many radio stations are confronted with the daily ritual of recorder checking and adjusting. Added to the time cost of such inspections is the cost of frequent parts replacements and loss of program time.

In contrast, Ampex users find their equipment will operate continuously eighteen hours a day with but infrequent inspection. Upkeep and replacements are almost nil; heads have remarkably long life. Ampex performance is constant over long periods of continuous operation. Long life with low maintenance is assured in each Ampex recorder by high manufacturing standards and complete test of each machine before shipment. It all adds up to one sure fact—Ampex quickly pays for itself out of savings from lower operating costs and added dependability.

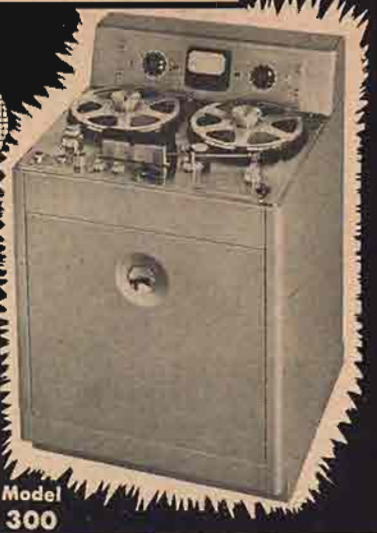

Model  
300

### Complete Specifications on Request

Shown is the time proven Model 300 Console. Throughout the field of professional audio recording this machine is the recognized leader.

STANDARD OF THE GREAT RADIO SHOWS

AMPEX ELECTRIC CORP.  
Redwood City, California  
Dealers in Principal Cities

# AMPEX

## Magnetic Tape Recorders

### We're not saying you MUST have AUDIO ENGINEERING

**BUT** our many readers think of AE as a sort of institution, a necessity for their interests and way of thinking. Our readers tell us they think AE is worth its price and much more.

**IF YOU ARE** interested in Audio (and who isn't, these days?), you know that AE IS THE ONE MAGAZINE DEVOTED TO AUDIO AND NOTHING BUT AUDIO.

**IF YOU WANT** to know what is happening in your field of work or how to better the sound equipment you are making for your living room, you'll want every issue of AE.

**SO,** before you miss one of the stimulating issues we have scheduled for the spring months ahead, fill out the coupon below. That one back issue you need most is generally sold out.

AUDIO ENGINEERING  
342 Madison Avenue, New York 17, N. Y.

Enclosed is my  check  money order for \$..... for my subscription to AUDIO ENGINEERING FOR  1 yr  2yrs.

Subscription Price in U. S. A. and Canada and Pan American Union: 1 yr—\$3; 2 yrs—\$5. Add \$1. per year for foreign subscriptions.

Name (please print) .....

Address .....

City ..... Zone ..... State .....

Occupation (give title and department) .....

Firm name .....

db average maximum sound pressure level, the input to the audio amplifier from radio receiver or phonograph-pickup circuits should be adjusted to produce about that output level at maximum output position of the compensated volume control. The curves of Fig. 14 will facilitate such adjustment if a standard frequency record (or audio oscillator) and output voltmeter are available. The proper input level is not a highly critical matter, since record and radio program average levels and balance vary. If the loudspeaker conversion efficiency is  $1\frac{1}{2}$  or 6 per cent instead of 3, it will produce only plus or minus 3 db error in setting up the level by the curves of Fig. 14. A good memory for the way music sounds in the concert hall may not be as unreliable a criterion for adjusting the input level as it may seem offhand.

### Conclusions

The author has found that a compensator designed on the basis discussed above is a very desirable addition to a wide-band radio-phonograph system in home use. It appears to make music much more tolerable to the casual listener. Because of this factor of less annoyance to other people who may not particularly wish to listen, proper automatic bass compensation should always be considered for inclusion in entertainment receivers intended for either civilian or military use. The military types generally operate in rather noisy locations with many persons present, and especially need the advantage shown in Fig. 12.

The following conclusions have been reached as the result of this study:

(a) Automatic bass compensation, as obtained by combination with the volume control, is highly desirable in entertainment receiver and phonograph equipment.

(b) Because they are plotted on the basis of an arbitrary change in sound pressure or intensity level between curves, the so-called Fletcher-Munson curves do not provide a direct indication of loudness sensation. If a control having a linear rate of change in db of loudness sensation is desired, curves of apparent loudness sensation in the mind versus sound pressure level should be used to determine resistance taper.

(c) An average maximum sound pressure level of 80 db at the listener's ears appears to be a desirable value for designing compensating circuits for entertainment purposes.

(d) It is feasible to include fixed high-frequency compensation to correct for deficiencies in various parts of the reproducing system to a reasonable degree, because the high-frequency response of the human hearing system is substantially constant at the sound pressure levels of interest.

(e) Most engineers interested in sound reproduction and many musicians, if allowed to listen at the levels they prefer, will need reproducing equipment of about 10 times the power rating required by the general public.

## LOUDSPEAKER DAMPING

[from page 13]

sible to go. The obvious approach is merely to increase the value of  $R$ , until the amplifier oscillates and then back off to a safely stable value. After this has been done the actual values attained may be measured and calculated as shown.

An alternate method of measurement is interesting and useful because of its simplicity and because it may be used to measure either positive or negative values. An a.c. bridge and a resistor are required. The resistor should be somewhat larger than the negative resistance the amplifier is expected to have and should be measured first on the bridge by itself. Then the resistor, bridge, and amplifier are connected as shown in Fig. 7 and the bridge is bal-

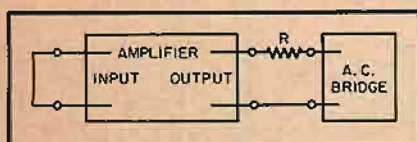

Fig. 7. Set-up for measuring output impedance.

anced. The input terminals of the amplifier are shorted and the only signal source used is that within the bridge. The resistance of the amplifier is the indication of the bridge at balance minus the resistor value.

If, for example, the resistor is 10 ohms and in the circuit of Fig. 7 the bridge balances at 5 ohms, the amplifier internal resistance is  $5 - 10 = -5$  ohms. A positive internal amplifier resistance may be measured simply by connecting the bridge to the amplifier without a resistor and accepting the indication of the bridge at balance.

All of the information given in this article has been checked extensively in the laboratory by independent empirical means. The writer has tried to be careful to include no assumptions that cannot be proved without so labelling them.

While it is true, as has been pointed out by Clements, that improved speaker damping demands a price in some decreased bass, the bass heard before was at least partly due to underdamping and consisted in some part of spurious cone excursions which tended to "compensate" for poor speaker-air coupling at low frequencies. The writer has not been able to detect any bass deficiency but has noticed a decided increase in clean and crisp sound. It is felt, in any case, that allowing a speaker to overshoot to compensate for deficient acoustic coupling between cone and air is a poor way of trying to get something for nothing.

The writer wishes to acknowledge the aid of Richard H. Dorf in organizing this material for publication and in acting as a reverberant sounding board against which to throw the ideas developed on dynamic negative feedback.



## JACK PANELS

**A complete line of jack panel assemblies and patch cords filling practically every need of the broadcast station.**

**In production now!**

Write for Bulletins R-15 and R-23 for complete descriptions

# TRIMM, INC.

SINCE 1922 LIBERTYVILLE, ILL.

# SONOCRAFT

**NEW YORK HEADQUARTERS**

*for* **SOUND-RECORDING EQUIPMENT & ACCESSORIES**



**McINTOSH AMPLIFIERS**



**MAGNECORDER**  
PT6's PT63's SERIES and PTCP Amplifiers  
**COMPLETE, EFFICIENT MAGNECORDER SERVICE.**  
Genuine MAGNECORDER parts available at all times.



**PRESTO**  
Tape Transport Mechanism TL-10  
for use with any 16" transcription table.

*Feature of the Month*

*We Make Immediate Delivery—Write For Complete Information*



## SONOCRAFT CORPORATION

115 WEST 45th STREET, New York 19, N. Y.  
3rd Floor Next to Times Square LU 2-1750

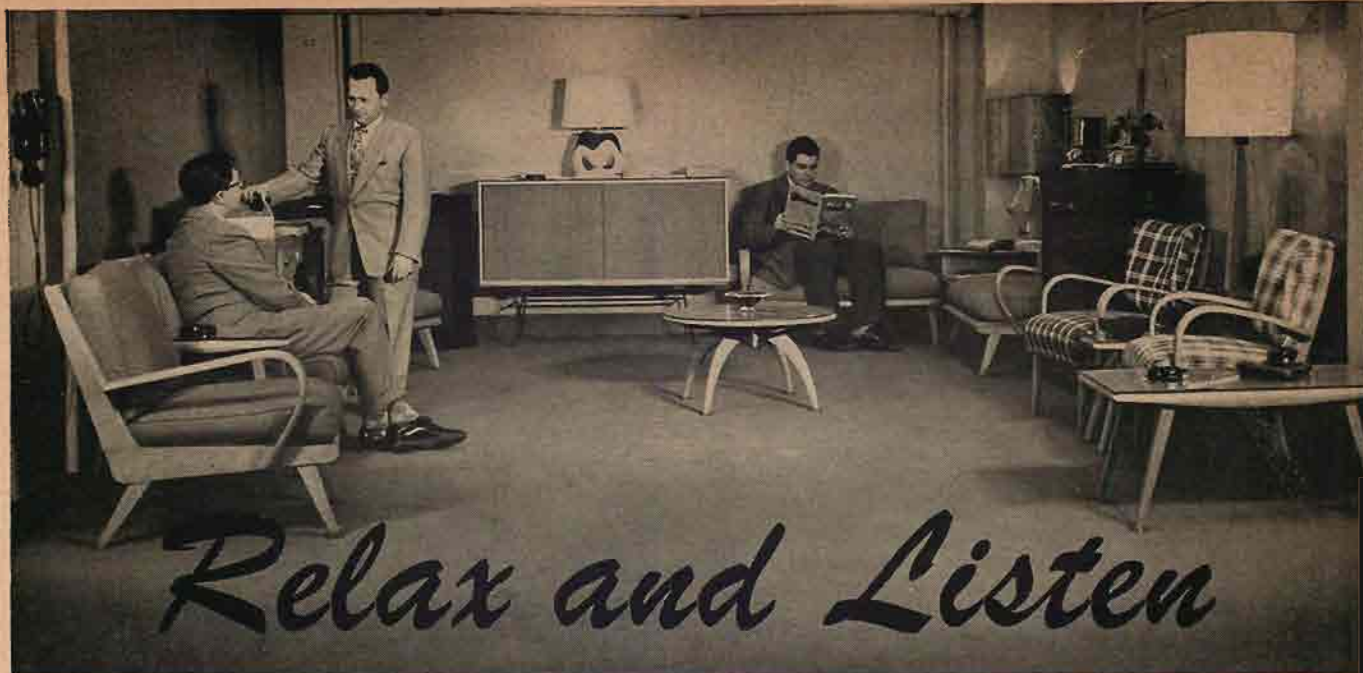

# Relax and Listen

Unique new sound showroom makes selection of equipment an adventure in comfort, with literally hundreds of combinations available to the listener's fingertips from his easy chair.

**N**EWEST rendezvous in New York for the hi-fi enthusiast is the elaborately equipped sound studio of Hudson Radio and Television Corporation at 48 West 48th Street, in the heart of the Radio City area. Unusual facilities have been provided here for prospective customers to make comparative tests of tuners, amplifiers, speakers, turntables, and phonograph pickups.

•  
 Manager Max Baume demonstrates various amplifier-tuner-speaker combinations to a customer, using the small remote-control unit. This device saves salesmen a lot of walking back and forth.



•  
 The studio occupies the entire mezzanine floor, independent of the parts-sales floor on street level. Wall-to-wall carpeting, comfortable chairs, and attractive lamps convey a "home atmosphere."

Each equipment position is equipped with input and output jacks and a d.c. operated relay for turning power on and off. Combinations of one input, two amplifiers, and two speakers are set up from a control box in the living-room section. Actual switching is performed by telephone-type stepping switches, and A-B tests between the two amplifiers or speakers are made by relays, also actuated from the control box. Equipment volume controls are pre-set, and final adjustment of volume is made with a master pot at the remote position. This arrangement is popular with customers because it enables them to make their selections easily. As many as 25 inputs, 50 amplifiers, and 50 speakers can be accommodated, although there aren't that many available models.

Left: Control cabinet for selector system, with cover removed to show inside wiring. Below, left to right: Main bank of tuners and amplifiers along a 22-foot wall, and group of speakers in demonstration cabinets of uniform size and finish along far end of studio.

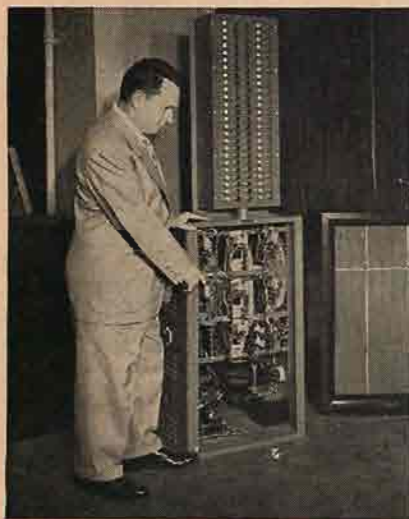

## BUFFALO RADIO SUPPLY

219-221 Genesee St.,

Dept. AE

Buffalo 3, New York

### MAGNAVOX HIGH FIDELITY RECORD DEMONSTRATORS

Sensational Bargain in Brand New Record Demonstrators (Built for Columbia by Magnavox)

- Amplifier designed in conjunction with the speaker to be capable of bringing you the storm and fire of Wagnerian opera or the light and lilting melody of Debussy with equal realism.
- Oversize 12" speaker
- Inclined sounding board
- Console Cabinet approximately a yard wide and a yard high
- 2 tone controls—Treble and bass—as well as 2 volume controls
- A pickup that is as gentle as a beam of winter sunshine. Intended to leave records in new condition after demonstration.
- 78 and 33 1/3 R.P.M. Originally 3-speed motor, but Columbia had the sleeve on the motor shaft for 45 R.P.M. removed, so the R.C.A. doughnuts could not be played. This can be re-installed for a few cents, if you must play the doughnuts.
- No expense was spared in producing these record demonstrators. They were Columbia's weapon in the savage, relentless and costly war between the titans in the record business that only ended when R.C.A. started to market 33 1/3 R.P.M. records under its own label.
- This buy of a lifetime is guaranteed to please you. Price only \$60.00. A quick sellout is certain at this low price. Rush your order.
- Extra special—We have a few of the Magnavox amplifiers alone, brand new and identical with the amplifier in the record demonstrator listed above. These have the separate bass and treble tone controls and volume control, and are complete with tubes. Believe it or not, we are letting these prizes go for a \$20.00 bill each. A bargain like this would be unbelievable before Korea, let alone now.



### SUPER HEAVY DUTY HIGH FIDELITY UNIVERSAL OUTPUT TRANSFORMER

by famous manufacturer



Flat within 1 db to 20,000 cps. Handles up to 125 watts without distortion • Hermetically sealed with 2500 volt insulation and porcelain stand-off terminals • 6 3/4" high and 14 lbs. net weight • 18 voice coil impedances available, plus 500 ohm line • \$80.00 value for only \$20.00.

### 35 MM SLIDE PROJECTOR & ENLARGER

Most terrific photographic bargain of the 20th Century. A fine precision instrument with many features!

- Takes roll film or 2 x 2 slides.
- Automatic slide changer furnished.
- No more waiting for enlargements to enjoy your candid shots. All you need is a flat surface to project on.
- Has 300 W 110 v Bulb, but 6v, 12v, 32v, or 220v available.
- 8 precision ground, optical glass elements in optical system. (No other projector on the market has more.)
- Automatic rewind of film.
- Heat absorbing filter.
- Use as an enlarger for making your own prints of any desired size.
- Plano-Convex Meniscus Condenser.
- 5" focus Brown-Violet coated, double anastigmat F:3.5 lens.
- Swivel projector head • Projector tilts to any angle on base • Brand new Society for Visual Education Model AAA Projector. Super Special \$50.



Similar SVE Projector for strip film only with regular 3" focus lens \$35.00

35 MM 150 W Projector similar to above for strip film with regular 1" focus lens \$15.00

### NEW 18-WATT UTILITY AMPLIFIER KIT

Kit Model SA, high quality wide range 18-watt public address amplifier. Matched component parts. 3-stage, high-gain circuit with push-pull 7C5 output tubes. Dual inputs for mike, phono or radio tuner. Fully shielded. Universal output to match any speakers used. Fully variable tone control on output. Complete with all parts and tubes. Super Special. \$16.95.



## TRAVELING MIKE

[from page 16]

specially constructed differential arrangement.

Ordinary curtain rail serves for the required mono-rail, and fine steel wire supports it throughout its length. Supports are combined with brackets for the pulleys that carry the mike lead across, four such pulleys being shown in Fig. 1. Notice that the rail should be erected with a slight arch, to prevent a tendency to buckle with the weight of the mike loading. The best degree of arching can be set up when installing the system, by running the carriage across (with the mike attached) and adjusting the tension of the support wires until mechanical stability is achieved.

The movement of the carriage must be noiseless, as any sounds made by it will be picked up by the microphone. This is achieved by using pulleys with rubber tires fitted as running wheels for the carriage, and also for the small wheels of the differential arrangement. Take care in construction that all wheels run freely and without being able to touch the chassis so as to scrape when traveling.

Figure 2 shows the construction of the differential in the carriage. When the carriage traverses, the stationary rotation control cord causes the differential pulleys to rotate in opposite directions. The microphone spindle is anchored to the differential hub, so no rotation of the mike is caused by this traverse action. But when the rotation control cord is moved by its control knob, both differential pulleys rotate in the same direction, thus rotating the differential hub and the microphone coupled to it. It is important to see that the microphone mounting is positively anchored to the spindle, and the spindle to the differential hub, as these points take the full weight of the mike.

Payout and hauling in of the mike lead is coupled to the carriage movement by means of the large pulleys in the main pulley system shown in Fig. 3 at the control side. These are locked to the same shaft so that the mike cable moves with the traverse cord. The mike lead is kept in close contact with its drive pulley by means of two jockey pulleys mounted inside the cover of the pulley system housing. This arrangement ensures that the connecting cable requires no attention. A bracket is fitted to the side of the mike carriage to drop the mike lead into the bearer pulleys provided at intervals along the rail to carry it. Figure 4 shows how this works.

### Operation

Control is two handed, but the mike stays put in any position so that the hands are not "tied to the controls." The right hand controls rotation of the mike head by means of a knob carrying a pulley for the endless cord operating the



## HOW LEADING NETWORKS USE Carter CONVERTERS

Photo above shows NBC's Tommy Bartlett and Universal Recording Company engineers making transcriptions from STORAGE BATTERY POWER by means of Carter Frequency Controlled Converter.

Wherever 115v. line voltage is not available, or hard to get, Carter Converters supply dependable AC power to make on location recordings. Operates from storage batteries. . . . Used by leading networks, broadcast stations, and program producers.

### Recommended by Brush and Magnecord

One model operates both Brush and Magnecord equipment. Delivers clean 60 cycle AC power. Requires no filtering. Frequency control feature compensates for 10% input voltage variation. Available for 6, 12, 24, 28, 32, 64, and 115v. DC input voltage. Size 8 1/4" x 5 1/2" x 7 1/2" high. Weight only 15 1/2 lbs. Performance Guaranteed!



## MAIL COUPON FOR FREE CATALOG

New Converter catalog illustrates entire line of Carter Rotary Converters for recording, TV, sound projection and transcription players. SELECTOR CHART included tells model to suit your purpose. Mail Coupon now for your copy and name of nearest Carter distributor.



## Carter MOTOR COMPANY

2648 N. MAPLEWOOD AVE., CHICAGO 47

Carter Motor Co.  
2648 N. Maplewood Ave.,  
Chicago 47, Ill.

Please send catalog #349 with information on Frequency Control Converters, and name of nearest distributor.

Name .....

Station or .....

Company .....

Address .....

- ✓ On-the-Spot News
- ✓ Sidewalk Interviews
- ✓ Conference Recording
- ✓ Courtroom Reporting
- ✓ Traveling Secretary
- ✓ Salesmen's Reports
- ✓ Confidential Recording
- ✓ Lecture Note-taking
- ✓ Missionary Work
- ✓ Testimony Recording

If your Recording Jobs  
are like these...you need

## THE MAGNEMITE\*

### The 10-Pound Portable BATTERY-OPERATED TAPE RECORDER

The MAGNEMITE\* offers convenience in field recording never before attained. This unusual unit measures only 11 1/2 x 8 1/2 x 5 1/2 inches, and weighs only 9 3/4 lbs., including its self-contained batteries which last 100 operating hours. At 1 7/8 in. per sec. tape speed, 2 full hours of recordings are accommodated on standard 5 in. reels of tape. Constant tape speed is assured by means of a governor-controlled spring-wound motor that runs 15 minutes per winding. Recordings can be made up to a distance of 100 feet from the microphone. The same instrument may be used for playback through earphones or external amplifier. For any recording, in or away from home, office, or studio, it's the MAGNEMITE\*!



Net  
Factory Price **\$189<sup>50</sup>**

Complete with batteries,  
microphone, and earphones.

\* Trade Mark Reg.

Order today, or write for additional literature to:

## AMPLIFIER CORP. of AMERICA

398 Broadway

New York 13, N. Y.

Over the past few years AUDIO ENGINEERING has proven itself a valuable reference work worthy of a permanent place in your library. Many of the 1951 issues are exhausted, but you may have a complete bound volume of new copies for the entire year.

Order Now

Limited Supply

**\$8.95**

Radio Magazines, Inc.,

342 Madison Ave., New York 17, N. Y.

## 9205 DEGAUSSER

Demagnetizes magnetic tape and film  
to erase recording and residuals.  
Accommodates 5400 foot reels of 1/4"  
tape; 1000 foot, 35mm. Write for  
Catalogue. Net Price ..... \$69.50



### CINEMA ENGINEERING COMPANY

1510 WEST VERDUGO AVENUE, BURBANK, CALIFORNIA

Export Agents: Frazar & Hansen, Ltd. • 301 Clay Street • San Francisco, Calif., U. S. A.

differential "gear" in the carriage. The left hand moves the carriage back and forth by raising and lowering a conveniently placed handle. This handle, in conjunction with the rail terminal fixing and the floor fixture below it, carries a pulley system to step up the foot or so of vertical movement (which is all that is comfortably available by moving a handle vertically) to a horizontal movement covering the whole length of the rail. Figure 3 clarifies this system, all except the essential pulleys and cord being omitted in the interests of clarity.

All types of cord are slightly elastic, although a cord giving a good combination of strength with pliability should be

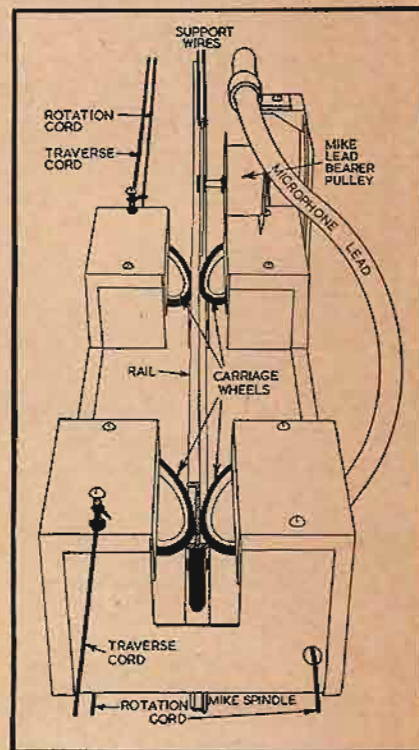

Fig. 4. End view of the microphone carriage on a section of monorail, to illustrate how the mike-lead clamp lays the lead in the bearer pulleys mounted on the rail supports.

chosen. It should be quite flexible, yet with little stretch. The residual possibility of stretching means that precautions must be taken to prevent cords from leaving their pulleys when tension in one place due to movement allows slackness to appear elsewhere. Lengths of tension spring are included in each cord to take up this slack automatically. Three springs are required, one for each of the three lengths of cord in the system. The "endless" rotary control cord has one, to connect together its two ends. The other two cords make up an "endless" arrangement, with the carriage inserted at one point and the control handle virtually at another. (Actually there are two ends, anchored at top and bottom of the pulley multiplying system, but if the drive were direct, i.e. so both handle and carriage moved at the same rate, the system would be truly "endless"). A spring is inserted in each of the ends of these cords, one to take up

No other Mike Stands  
OFFER SO MUCH AS  
**ATLAS**

*the COMPLETE  
STUDIO LINE*

**MAXIMUM STABILITY:** Maximum base mass is concentrated at outer periphery. Bases are self-leveling, shock-absorbing, anti-tip, anti-scratch.

**MAXIMUM QUIET AND EASE:** Special Full-Grip, Velvet-Action clutches, inner-lined with wear-proof locking collets, function smoothly at slight pressure, yet cannot creep, jam, rasp, jolt or jar.

**MAXIMUM WEAR:** Heavy oversized tube assemblies are super-chrome plated for highest durability.

**MAXIMUM VARIETY:** Floor or table, boom, orchestra or collapsible types—there's an ATLAS stand for your every studio need.

COMPARE ATLAS at your distributor TODAY. See why more studios specify ATLAS than any other line. Write NOW for FREE latest Catalog 551.

ATLAS also leads in the manufacture of public address loudspeakers and accessories.



**ATLAS SOUND CORP.**  
1448-39th Street, Brooklyn 18, New York  
In Canada: Atlas Radio Corp., Ltd., Toronto, Ont.

**THE  
IDEAL  
HORN**



**IMMEDIATE  
DELIVERY**

... For use in 2-way and 3-way speaker systems having low cross-over frequencies. Especially adapted to corner speakers using folded low-frequency horns of the Klipsch type. Acoustical cut-off: 330 cycles. Dispersion angle: horizontal 90°; vertical 60°. Non-resonant, accurate, metal casting. Permanent non-warping, unit construction... superior to assembled horns.

Model H-330 H. F. HORN—List Price \$108  
With adaptor for Electrovoice T10 and T25, Lansing D175, Stephens P15 and 108. Adaptors available for other driver units.

**For FINEST  
PHONOGRAPH  
REPRODUCTION**

**PREAMPLIFIER  
EQUALIZER** List:  
A100 \$55; A100P  
(Self powered)  
\$83.33



For information on these and other high quality components, write

**BROCINER** ELECTRONICS  
LABORATORY  
1546 SECOND AVENUE • NEW YORK 28, N. Y.

slack when pulling one way, and the other for pulling the other way.

In the traverse operation, even with springs, it would be possible to produce slack by pulling too hard in either direction, so one spring would extend more than intended and the other would completely relax. To avoid this possibility, limiting wires are added to the back and forth springs, so that they cannot be overstretched to the point where the other cord would become slack. This arrangement gives particularly smooth operation, with freedom from trouble.

All the parts, with the exception of the various pulleys, the monorail, and the mike itself, are constructed quite simply from sheet metal, using a little amateur tinsmith's art. The pulleys, rubber tires, and their spindles can be purchased as spares for any of the variety of toy construction kits on the market.

## LINEAR-SCALE AF WATTMETER

[From page 17]

couple meters are not designed to stand much overload—probably not over 10 per cent at the most. Therefore, care should be taken to set the load switch to 16 ohms for a few initial measurements to make sure that the amplifier could not exceed the 32-watt level—with the leads being connected to the appropriate 16-ohm output terminals. If it is found that the amplifier output does not exceed 32 watts, the leads may be reconnected to the 8-ohm terminals and the more expanded scale employed.

### Applications

Most steady-state measurements are made with a fixed output power for a period of time; i.e. the duration of the measurement is sufficient for the sluggish action of a thermocouple meter. Such a meter would not be suitable for any kind of program material because it is incapable of following the audio envelope at all closely. In making a series of IM measurements it has become standard practice to start at the maximum output power expected—or determined by measurement—and to progress downwards in power output, making distortion measurements at 1-watt intervals. This avoids the need for reducing the calibration setting before making each successive power-output increase. By starting at the top and reducing the power watt by watt, the calibration control is advanced slightly with each change in output.

Spot checks with an a.f. voltmeter have shown the thermocouple meter to be accurate within the needs of production testing, and the added convenience of direct output-power indications on a linear scale have made the additional investment for the meter well repaid in time saved.

*Air-Tone*

**HEADQUARTERS FOR  
SOUND EQUIPMENT**

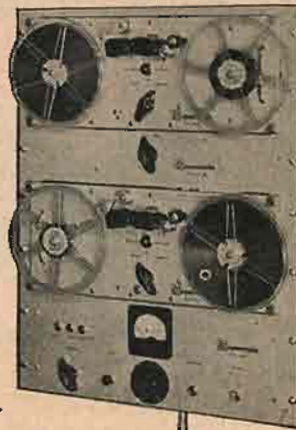

**MAGNECORD  
RECORDER & AMPLIFIER**

Complete Systems from \$564.00



**NEWCOMB  
AMPLIFIER**

Complete line of High Quality Amplifiers,  
from small single units to large rack  
installations



**ELECTRO-VOICE SPEAKERS**  
From \$27.00 to \$756.00 NET

*Air-Tone*

**SOUND AND RECORDING CO.**  
1527 CHESTNUT ST.  
PHILA. 2, PA. • RI-6-8388

**FREE! INDUSTRIAL  
TUBE  
BOOKLET!**



**JUST  
OFF  
THE  
PRESS!**

**Purchasing  
Agents!  
Engineers!**

Write today for this highly informative booklet. Complete technical specifications of all leading brands and types of tubes for all electronic applications—silicon diodes, germanium crystal diodes, thyretions, pilotrons, kenotrons, phanotrons, photo tubes, xmitting types, etc. Lavishly illustrated. Address Dept. AF.

**Also COMPLETE STOCKS of ALL TYPES  
RADIO-ELECTRONIC EQUIPMENT**

**MILO RADIO  
& ELECTRONICS CORP.**

200 GREENWICH STREET, NEW YORK 7, N. Y.  
Phone BEekman 3-2980 • Teletype NY1-1839

**SOUND WHERE  
YOU WANT IT!**

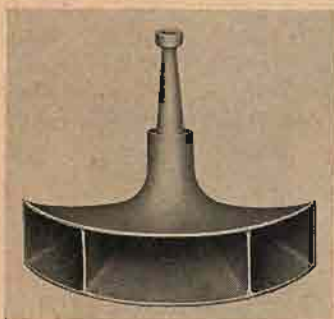

**COB-11 COBRA HORN**

This horn projects sound *only* where it is needed. Distribution pattern of 40° x 120° results in a concentrated beam of sound without "up in the air" losses and ground reflections. **CUTS COSTS . . .** The elimination of reflex members in its "straight" horn design increases sound output and reduces amplifier input power up to 40%. Also excellent as a mid-range or high frequency horn in 2 and 3 way wide range systems. Heavy cast aluminum throughout. Cut-off is 250 cps and thread size is standard. Dimensions 17-3/8" H, 22-1/4" W, 13-3/8" D. Free catalog.

In Canada:  
Dominion  
Sound  
Equipments,  
Ltd.

**Racon Electric Co. inc.**  
52 East 19th Street, New York 3, N. Y.

## AES News

**T**HE Third Lecture Series given by the Audio Engineering Society began on January 10 with H. H. Scott's paper on "The Amplifier and its Place in the Circuit—A Survey." W. R. Ayres gave the second lecture on "Power and Voltage Amplifiers" on January 17, and attendance was around 100 at both meetings.

Availability of lecture notes on this series will be announced at the close of the six-week course.

The Los Angeles Section of the AES recently elected new officers. Those chosen to serve during 1952 were: Boyd McKnight, Chairman; Richard Hastings, Vice-Chairman; Carl Shipman, Secretary; and Western Vice-President Howard Tremaine as Secretary.

Frank Gilbert of Stephens Manufacturing Company provided the technical portion of the December 18th meeting with a talk and demonstration of a new, small wireless microphone for use in TV and movie studios.



## Employment Register

**POSITIONS OPEN and AVAILABLE PERSONNEL** may be listed here at no charge to industry or to members of the Society. For insertion in this column, brief announcements should be in the hands of the Secretary, Audio Engineering Society, P. O. Box 12, Old Chelsea Station, N. Y. 11, N. Y., before the fifth of the month preceding the date of issue.

★ Positions Open • Positions Wanted

★ **Salesman.** For leading distributor of sound and recording equipment in metropolitan New York area. Box 201, AUDIO ENGINEERING.

★ **Repairman** for tape and disc recording equipment. Full or part time. Box 202, AUDIO ENGINEERING.

★ **Engineers.** White Sands Proving Ground needs several engineers of all types immediately, with excellent opportunities in research, engineering, and development on guided missiles and component parts. Classifications needed are: civil or mechanical, GS-11, \$5940; electrical, GS-9, \$5060; mechanical, GS-5, \$3410; electronic (general), GS-9, \$5060; mechanical GS-7, \$4205; electronic (2) GS-11, \$5940; mechanical, GS-11, \$5940; engineers, all options, GS-5 and GS-7, \$3410 and \$4205; All salaries on per annum basis. Send Standard Application Form 57, obtainable at any Post Office of Civil Service Board of Examiners to Civilian Personnel Office, Ordnance Corps, at White Sands Proving Ground, Las Cruces, New Mexico.

● **Recording Technician:** Has good, all-around background with medium-sized organization. Experienced in standard pitch and microgroove recording, and tape. Excellent tape editor. Versed in studio supervision, microphone techniques, monitoring, and all techniques related to mastering and dubbing. Works well with recording artists. Knows music; can read and edit from score. Sidney C. Silver, 107 Brooklyn Ave., Brooklyn 16, N. Y. Phone HYacinth 3-0491.

## CLASSIFIED

Rates: 10c per word per insertion for noncommercial advertisements; 25c per word for commercial advertisements. Rates are net, and no discounts will be allowed. Copy must be accompanied by remittance in full, and must reach the New York office by the first of the month preceding the date of issue.

**FOR THE FINEST** Audio system, or improve your old one, call Arthur Levine, OLInville 2-8615.

**THE AUDIO EXCHANGE** buys and sells high-fidelity sound systems and components. Guaranteed used and new equipment. Catalogue, Department AE, 159-19 Hillside Ave., Jamaica 32, New York. OL 8-0445.

**FOR SALE:** Meissner 9-1001 FM-AM tuner, Thordarson T-31W11 volume-expansion amplifier. Excellent condition; together or separately. Martin Stark, 550 Plaget Ave., Clifton, N. J., or NYC telephone PLaza 7-1200, Ext. 5867 9 a.m. to 4 p.m.

**SAVE \$7.50!** PICKERING D-140S Diamond Stylus LP Cartridges only \$28.50 each. Brand new, in sealed boxes, guaranteed. Skalamera, 435 E. 74th St., New York 21, N. Y. BU 8-2057.

**ELECTRO-VOICE "Slim-Jim" Professional Microphone, Model 655,** cost \$120—your price \$95. Matched pair Pickering Diamonds, 7S and 33, cost \$60—your price \$45. Gray Model 602 Professional Equalizer, cost \$49.50—your price \$35. Above are all brand new, unused. Money orders only. I.o.b. New York. R. Bennis, Box CF-1, AUDIO ENGINEERING.

**REVERBERATION-time meter,** like-new condition. \$150 for quick sale. Box CF-3, AUDIO ENGINEERING.

**TAPE RECORDER—Twin-Trax ACA Model 540C.** Automatic two-way switchover system for two rack-mounted Twin-Trax chassis, 4-in. VU meter, dubbing amplifier for copying tapes, 1 year old, excellent condition. Original cost \$842; will accept best offer. Mr. Salerno, 65 Tonnele Ave., Jersey City, N. J. Henderson 5-6365.

**WILL TRADE OR SELL:** Sync Wire recorder mechanism, 50 spools wire recorded with concert music. Jensen JAP-60 speaker, Winchester 52 target rifle, Colt match-target pistol, 22 cal. ammo. Super Ikonta BX Camera. Want Magneorder or Concertone Tape Recorder. Agress, 260-63 75th Ave., Floral Park, N. Y.

**FOR SALE:** Presto RC-10-14 recorder (three motors, hysteresis motor on capstan), 900-A-1 Amplifier, revolution counter, all on 4-ft. rack on casters; E-V 645 microphone, stand, 30 hrs. use, all in excellent condition. \$1100 value for \$725. Phone TRafalgar 9-7290, New York City, or Box CF-1, AUDIO ENGINEERING.

**PRESTO 900R1 Tape Recording Mechanism,** \$325. RCA 15-watt P.A. amplifier, \$60. Transcription arm with new G.E. cartridge, \$25. Pilotuner and Presto AM tuner, \$90. Reco-Art, 1305 Market Street, Philadelphia, Pa.

**WORLD'S FINEST Recording Wire!** Lear Premium, guaranteed 6 db better HF response. Hear the difference! List \$7.50, wholesale \$4.50; your cost only \$3.95, or \$3.00 in quantity. 2327 Arthur St., Los Angeles 65, Calif.

## PROFESSIONAL DIRECTORY

Custom-Built Equipment

**U. S. Recording Co.**

1121 Vermont Ave., Washington 5, D. C.  
Lincoln 3-2705





### THE ARM WITH A HAND

Has "SLIDE-IN" Cartridge Holder

This fine quality Clarkstan tone arm features a special Slide-In cartridge holder that accommodates all standard cartridges, including the General Electric RPX-050. It's easy to use . . . no soldering . . . just twist a thumb screw and the cartridge is securely held in place. Positive electrical contact is assured by silver plated spring-loaded plungers. Accurate balance is easily maintained by a quick weight adjustment that gives proper needle force. The Clarkstan Arm plays all LP, microgroove and standard records. Comes in two sizes for records up to 12" and 17". See your jobber or write for bulletin #172-F

- |      |  |             |
|------|--|-------------|
| 212  | Transcription Arm for 16" transcriptions   | Net \$19.90 |
| 212G | Transcription Arm same as 212, but slotted to accommodate GE cartridge RPX-050 as well as all others | Net \$19.90 |
| 213  | Record arm for 12" records   | Net \$18.90 |
| 213G | Record arm same as 213, but slotted to accommodate GE cartridge RPX-050 as well as all others        | Net \$18.90 |

**CLARKSTAN**  
CORP.

ELECTRONICS DIVISION 8A

11921 W. PICO BOULEVARD  
LOS ANGELES 64, CALIFORNIA

If you are moving, you must notify our Circulation Department at least 5 weeks in advance. The Post Office Dept. does not forward magazines sent to wrong destinations unless you pay additional postage, and we can NOT duplicate copies sent to you once. Please give old and new addresses.

RADIO MAGAZINES, INC.

342 Madison Ave.  
New York 17, N. Y.

### WHY WILL YOU CHOOSE YOUR TAPE RECORDER?

Q. Higher Fidelity and Smoother Performance?

**A. THEN BUY TWIN-TRAX!\***

Q. Longer Continuous Playing Time?

**A. THEN BUY TWIN-TRAX!\***

Q. Professional Specifications at Popular Price?

**A. THEN BUY TWIN-TRAX!\***

Q. Wider Selection of Models?

**A. THEN BUY TWIN-TRAX!\***

No matter which of these features you consider most important. You'll find them all—and many other exclusive features—in our Twin-Trax Recorders. Send today for your free copy of our Catalog 25272. \*Reg. U. S. Pat. Off.

**AMPLIFIER CORP. OF AMERICA**

398 Broadway, New York 13, N. Y.

## Book Review

Make Music Live, by Irving Greene, James R. Radcliffe, and Robert Scharff. 256 pp. New York: Medill McBride Company, Inc., \$4.50.

Covering the entire subject of high-fidelity reproduction of music in the home, this is the first volume directed entirely to the non-technical reader who has succumbed to the desire for better sound quality. The first four chapters are devoted to a description of the four basic elements of the home system—record player, tuner, amplifier, and loudspeaker—followed by a discussion of speaker enclosures and their requirements for good reproduction over the entire audio spectrum. The next five chapters cover the planning of the physical layout of the home system, with practical ideas for installation in bookshelves or other furniture elements, and another chapter covers the construction and finishing of home-built cabinetry. The authors also discuss tape recorders, primarily from the viewpoint of the person who plans to assemble these units into a present or projected system. A glossary of hi-fi terms is included, along with chapters on High-Fidelity Records by Walter Gruening, record reviewer for Consumers' Research, Inc., and on Tonal Quality and Fidelity by Peter Hugh Reed, editor of *American Record Guide*.

The book is recommended reading for the non-technical person who wishes to assemble a home music system for his own use, since it is full of valuable pointers on "how-to-do-it." It is not a book which would interest the technically minded individual who enjoys building the various components—the kind of person who is usually called an "audio hobbyist."

## Industry People

R. S. Fenton, vice-president, announces appointment of Floyd J. Van Alstyne as Jobber Sales Manager of Permosflux Corporation. . . . Arthur Priest announces resignation as ad manager of Leonard Radio, Inc., New York—future plans will be announced soon. . . . George Silber, president of Rek-O-Kut, combining business with pleasure in trip to Florida with family (Ed's note: How he do dat?). . . . Dr. Ralph Bown, director of research for Bell Telephone Laboratories since 1946, elevated to vice-presidency. . . . Herman Holstein has resigned as ad manager of Lafayette Radio, Inc., New York. . . .

Kenneth Boothe, Audio & Video Products Corp. exec, announces appointment of Paul Baran as field engineering representative. . . . Promotion of Phillip Barnes to director of the sales division of Weston Electrical Instrument Co. is announced by Earl B. Mellon, president. . . . Dr. A. W. Friend has joined Magnetic Metals Co., Camden, N. J., as director of engineering and research. . . . U. S. Chamber of Commerce has expanded radio and television services with George E. Sandefer, formerly of NBC, as director. . . .

New manager of sales operations for RCA Tube Department is Douglas Y. Smith, eligible for a quarter-century pin in RCA service. . . . E. N. Kollogg, Jr. is new advertising director of Burlingame Associates, New York. . . . Henry C. Roemer, v.p. of Federal Telephone and Radio Corp. since 1950, has been elevated to presidency. . . . Frank Robbins and Bill Joseph, co-inventors of the R-J Speaker, are literally swamped with letters asking when and where the unit will be available. . . . Rudy Bozak, president, R. T. Bozak, Inc., Buffalo, N. Y., beaming at results of recent tests of Bozak speaker by a well-known Eastern university.

## AMPERITE

Studio Microphones  
at P.A. Prices

Ideal for  
BROADCASTING  
RECORDING  
PUBLIC ADDRESS

"The ultimate in microphone quality," says Evan Rushing, sound engineer of the Hotel New Yorker.

• Shout right into the new Amperite Microphone—or stand 2 feet away—reproduction is always perfect.

• Not affected by any climatic conditions.

• Guaranteed to withstand severe "knocking around."



Models  
RBLG—200 ohms  
RBHG—Hi-imp.  
List \$42.00



"Kontak" Mikes  
Model SKH, list \$12.00  
Model KKH, list \$18.00

Special Offer: Write for Special Introductory Offer, and 4-page illustrated folder.

**AMPERITE Company, Inc.**

561 BROADWAY • NEW YORK 12, N. Y.

Canada: Atlas Radio Corp., Ltd., 560 King St. W., Toronto



Plays all speeds

**GARRARD**

"Triumph"

**WORLD'S FINEST  
RECORD CHANGER**

Fully automatic with automatic stop  
Easily installed in your present set.

Write for FREE literature

GARRARD SALES CORP., Dept. 2E  
164 Duane St., New York 13

Gentlemen:

I am interested in learning what to look for when purchasing a 3-speed record changer. Please send me, without obligation, your FACT SHEET.

NAME .....

ADDRESS .....

CITY ..... ZONE ..... STATE .....

**A SUGGESTION  
THERE IS SOME TRUTH**



**IN OUR ADVERTISING**

While we were in America, we had the chance to have the performance of the 215 speaker in its Baffle measured by one of the best equipped sound laboratories in the U. S. A. As you will know, we are rather averse to publishing response curves, since they can be so easily misinterpreted, and we wondered just what this opportunity would reveal.

Our own measuring equipment is not truly reliable beyond 15,000 cps, and our previous curves have not shown what happens beyond 10,000. This time we were going to get a story up to 20,000. What would that story be?

We had estimated what the speaker actually did beyond 15,000, which accounts for our claim that it will show up extremely well against any multiple unit system, but could we prove it by measurement? The unqualified answer is "Yes." We are much gratified that independent measurement has confirmed what we thought the speaker really does, and we are even more gratified at an astonishing set of polar curves which show that the 215 has a truly wonderful forward spherical radiation.

These curves are being embodied in a technical report covering the performance of the 215 in detail. A copy will be sent to everyone on our mailing list, and anyone else who is interested—and every high-fidelity enthusiast will be interested to find what can be achieved at so little cost—need only send us a postcard bearing the words "215 report please", and your name and address.

We are often told that our advertisements tend to carry conviction, and that is gratifying to us. Nevertheless, we are glad to be able to prove to you that everything we have said about the 215 speaker is true—by measurement.

**The Hartley-Turner 215 Speaker  
is the greatest bargain in the  
world of high-fidelity.**

Price only \$48.00. Import duty \$6.00

**H. A. HARTLEY CO. LTD.**  
152, Hammersmith Road  
London W.6, England

**ADVERTISING  
INDEX**

Air-Tone Sound & Recording Co. ....	37
Altec Lansing Corp. ....	22
Amperite Co., Inc. ....	39
Ampex Electric Corp. ....	32
Amplifier Corp. of America ....	36, 39
Arnold Engineering Co., The ....	5
Atlas Sound Corp. ....	37
Audak Co. ....	21
Audio Devices, Inc. ....	Cover 2
Bell Telephone Labs, Inc. ....	10
Bogen, David Co., Inc. ....	40
Brociner Electronics Lab ....	37
Buffalo Radio Supply ....	35
Cannon Electric Co. ....	24
Carter Motor Co. ....	35
Chicago Transformer Co. ....	4
Cinema Engineering Co. ....	36
Clarkstan Corp. ....	39
Classified Ads ....	38
Daven Co., The ....	Cover 3
El-Tronics, Inc. ....	31
Garrard Sales Corp. ....	39
Gates Radio Co. ....	9
Hartley, H. A. Co. Ltd. ....	40
Harvey Radio Co. ....	30
Heath Co., The ....	23
Hudson Radio & Television Corp. ....	7
Lansing Sound, James B., Inc. ....	28
Leonard Radio, Inc. ....	29
Magnecord, Inc. ....	6
Milo Radio & Electronics Corp. ....	38
Minnesota Mining & Mfg. Co. ....	25
Partridge Transformer Ltd. ....	40
Pickering & Co., Inc. ....	31
Professional Directory ....	38
Racon Electric Co., Inc. ....	38
Rek-O-Kut Co. ....	1
Reeves Soundcraft Corp. ....	3
Sonocraft Corp. ....	33
Terminal Radio Corp. ....	26
Triad Transformer Mfg. Co. ....	2
Trimm, Inc. ....	33
Turner Co. ....	27
U. S. Recording Co. ....	38
United Transformer Corp. ....	Cover 4

**PARTRIDGE  
WILLIAMSON  
OUTPUT TRANSFORMER**  
*Built to the  
original specification*

De-luxe model now available from stock from all important Radio Stores throughout the U.S.A. (Price \$26.00 duty paid)

This transformer is now accepted as the most efficient in the world. According to "Audio Engineering" (Nov. 1949), there is no U.S. equivalent. Thousands already sold in the U.S.A.

Partridge CFB Output Transformer, accepted as without rival. Series leakage induct. .10 mh., primary shunt induct, 130 H., with "C" core construction and hermetically sealed. (Price \$40.00 duty paid)

**The Following Stores are among those now Stocking Partridge Transformers.**

Harvey Radio Co. Inc. 103 West 43rd Street, New York 18.	Terminal Radio Corporation 85, Cortlandt Street, New York 7.
Electronic Wholesalers Inc. 2345 Sherman Ave., Washington, D. C.	Gates Radio Company, 2700 Polk Avenue, Houston Texas.
Radio Electric Service Co. 5 North Howard Street, Baltimore 1, Maryland.	Wholesale Radio Parts Co., Inc. 311 W. Baltimore St., Baltimore 1, Maryland.
Gates Radio Company, Quincy, Illinois.	Sole Agents in Canada: Atlas Radio Corporation, 560 King Street West, Toronto 2-B.

If you are unable to purchase Partridge transformers in your city, write to us and mention the name of your dealer.

Fullset data, including square-wave tests, distortion curves, etc., together with list of U. S. stockists rushed Air Mail to you.

**PARTRIDGE TRANSFORMERS LTD.**  
TOLWORTH, SURREY, ENGLAND

**THE Bogen  
BATON!**

Model H010 High Fidelity Amplifier and Model RXPX Remote Controller  
**YOU LEAD THE ORCHESTRA**—from your favorite easy chair—with complete remote control of function selection, volume, tone and record equalization. Permits instant adjustment for maximum enjoyment of each selection on radio or phonograph. Handsome, compact remote control unit complements every decor.

Write for FREE catalog 'A-2

**David Bogen  
CO., INC.**  
663 BROADWAY, NEW YORK 12, N. Y.

PIONEERS IN HIGH FIDELITY FOR OVER 20 YEARS

Q

Are all brands of Resistors similar in Quality, Specifications and Performance?

A

Naturally, no! That's why DAVEN has earned the right to add a superlative in naming its line

Brands of Resistors vary as widely in the completeness of a line and in performance, as do brands of any other product.

DAVEN originated the first pie-type, wire wound Resistor more than a generation ago. Since that time, DAVEN has designed and manufactured Precision Wire Wound Resistors of every conceivable type to meet the increasing demands of the electronics industry.

SUPER DAVOHM RESISTORS are noted for their high stability and accuracy under extreme temperature and humidity conditions. DAVEN Resistors are made in accordance with JAN-R-93 specifications and are in use in all types of Army, Navy and Air Force electronic equipment.

DAVEN has developed special small precision Resistors for use in miniaturized assemblies. All types of mountings, sizes, tolerances and temperature coefficients are available from a large variety of standard types. That's why DAVEN can fill your precision Resistor needs.

Take advantage of DAVEN's advanced engineering and manufacturing techniques to help with any Resistor problem confronting you.

Visit DAVEN at the I.R.E. Show. Booths 94B & 95.

THE DAVEN CO.  
185 CENTRAL AVENUE  
NEWARK 4, NEW JERSEY



# SUPER DAVOHM

PRECISION WIRE WOUND

# RESISTORS

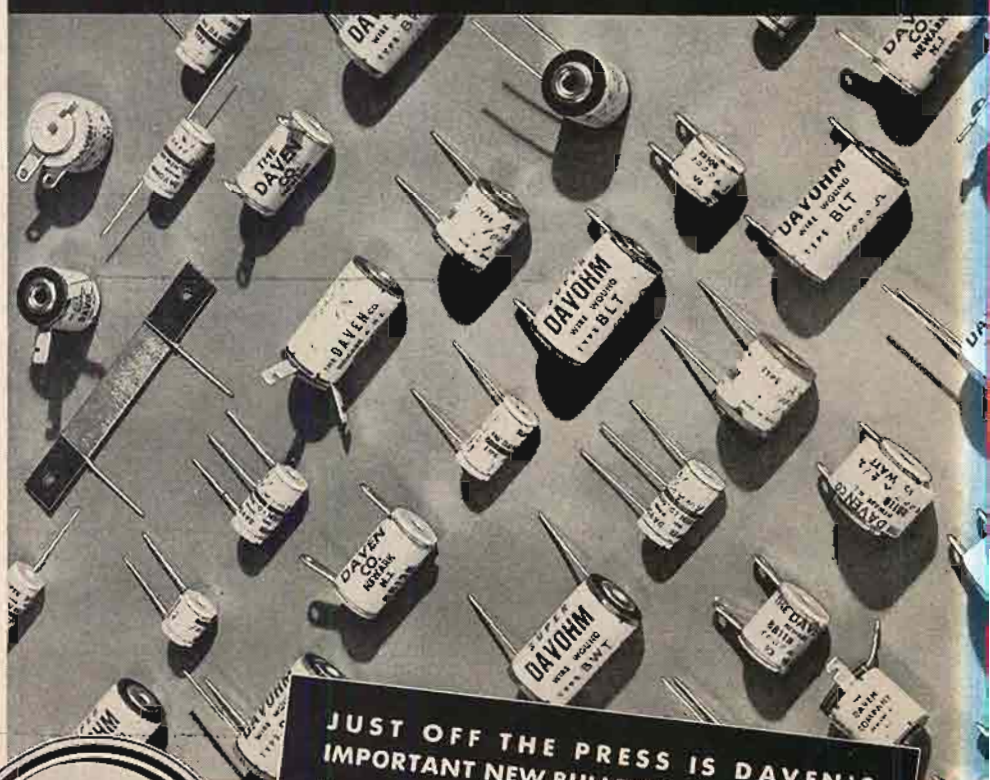

JUST OFF THE PRESS IS DAVEN'S IMPORTANT NEW BULLETIN ON RESISTORS. Write for your copy today and prove to yourself, from the information supplied, that when you order Resistors you should specify only . . . SUPER DAVOHM Precision Wire Wound RESISTORS



## PERMALLOY DUST TOROIDS FOR MAXIMUM STABILITY...

The UTC type HQ permalloy dust toroids are ideal for all audio, carrier and supersonic applications. HQA coils have Q over 100 at 5,000 cycles... HQB coils, Q over 200 at 4,000 cycles... HQC coils, Q over 200 at 30 KC... HQD coils, Q over 200 at 60 KC... HQE (miniature) coils, Q over 120 at 10 KC. The toroid dust core provides very low hum pickup... excellent stability with voltage change... negligible inductance change with temperature, etc. Precision adjusted to 1% tolerance. Hermetically sealed.



HQA, HQC, HQD CASE  
1 13/16" Dia. x 1 3/16" High



HQB CASE  
1 5/8" x 2 5/8" x 2 1/2" High



HQE CASE  
1/2" x 1 5/16" x 1 3/16" High

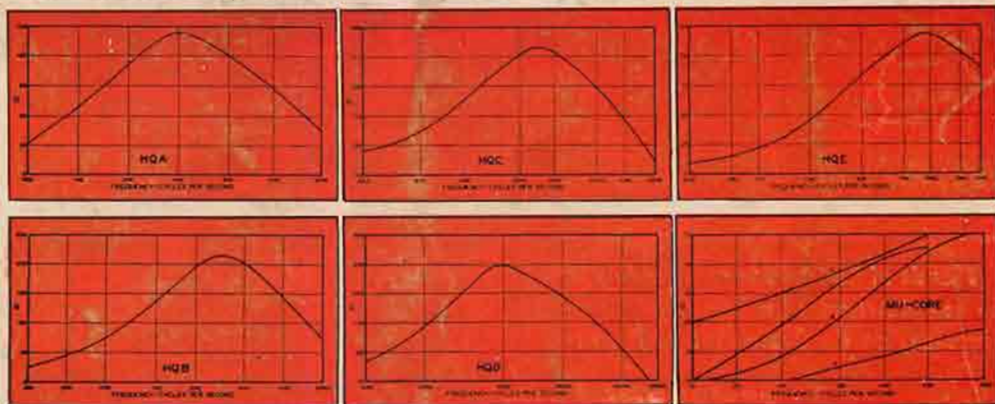

Type No.	Inductance Value	Net Price	Type No.	Inductance Value	Net Price	Type No.	Inductance Value	Net Price
HQA-1	5 mhy.	\$7.00	HQA-16	7.5 hy.	\$15.00	HQC-1	1 mhy.	\$13.00
HQA-2	12.5 mhy.	7.00	HQA-17	10. hy.	16.00	HQC-2	2.5 mhy.	13.00
HQA-3	20 mhy.	7.50	HQA-18	15. hy.	17.00	HQC-3	5 mhy.	13.00
HQA-4	30 mhy.	7.50	HQB-1	10 mhy.	16.00	HQC-4	10 mhy.	13.00
HQA-5	50 mhy.	8.00	HQB-2	30 mhy.	16.00	HQC-5	20 mhy.	13.00
HQA-6	80 mhy.	8.00	HQB-3	70 mhy.	16.00	HQD-1	.4 mhy.	15.00
HQA-7	125 mhy.	9.00	HQB-4	120 mhy.	17.00	HQD-2	1 mhy.	15.00
HQA-8	200 mhy.	9.00	HQB-5	.5 hy.	17.00	HQD-3	2.5 mhy.	15.00
HQA-9	300 mhy.	10.00	HQB-6	1. hy.	18.00	HQD-4	5 mhy.	15.00
HQA-10	.5 hy.	10.00	HQB-7	2. hy.	19.00	HQD-5	15 mhy.	15.00
HQA-11	.75 hy.	10.00	HQB-8	3.5 hy.	20.00	HQE-1	5 mhy.	6.00
HQA-12	1.25 hy.	11.00	HQB-9	7.5 hy.	21.00	HQE-2	10 mhy.	6.00
HQA-13	2. hy.	11.00	HQB-10	12. hy.	22.00	HQE-3	50 mhy.	7.00
HQA-14	3. hy.	13.00	HQB-11	18. hy.	23.00	HQE-4	100 mhy.	7.50
HQA-15	5. hy.	14.00	HQB-12	25. hy.	24.00	HQE-5	200 mhy.	8.00

## UTC INTERSTAGE AND LINE FILTERS



FILTER CASE M  
1 3/16" x 1 11/16",  
1 5/8" x 2 1/2" High

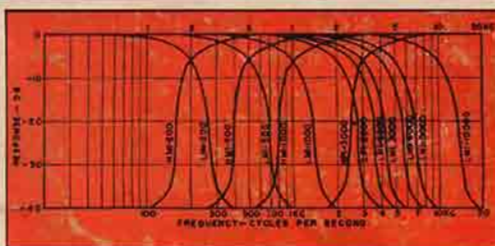
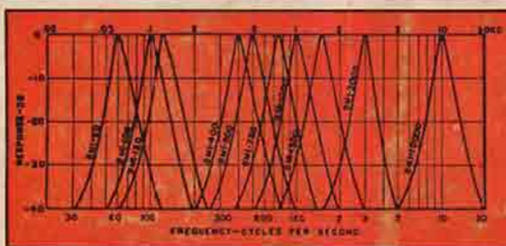

These U.T.C. stock units take care of most common filter applications. The interstage filters, BMI (band pass), HMI (high pass), and LMI (low pass), have a nominal impedance at 10,000 ohms. The line filters, BML (band pass), HML (high pass), and LML (low pass), are intended for use in 500/600 ohm circuits. All units are shielded for low pickup (150 mv/gauss) and are hermetically sealed.

**STOCK FREQUENCIES**  
(Number after letters is frequency)  
Net Price \$25.00

BMI-60	BMI-1500	LMI-200	BML-400
BMI-100	BMI-3000	LMI-500	BML-1000
BMI-120	BMI-10000	LMI-1000	HML-200
BMI-400	HMI-200	LMI-3000	HML-500
BMI-500	HMI-500	LMI-5000	LML-1000
BMI-750	HMI-1000	LMI-10000	LML-2500
BMI-1000	HMI-3000		LML-4000
			LML-12000

*United Transformer Co.*  
150 VARICK STREET • NEW YORK 13, N. Y.

EXPORT DIVISION: 13 EAST 40th STREET, NEW YORK 16, N. Y., CABLES: "ARLAB"